

RADIO-CRAFT

HUGO GERNSBACK, Editor

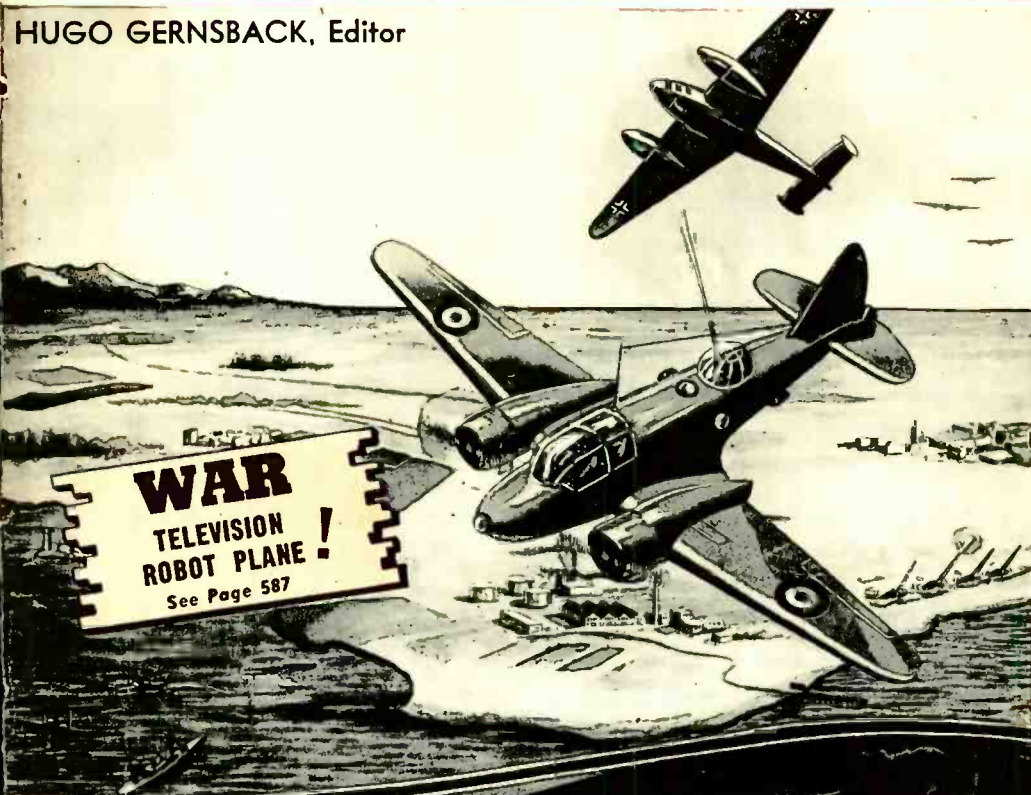

"FLIGHT COMMAND"

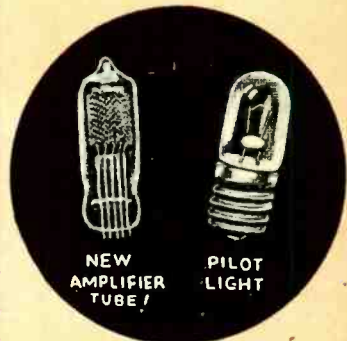

NEW RADIO TUBE!



FACTORY ELECTRONICS



TELEVISION RELAY

APRIL **RADIO'S GREATEST MAGAZINE**
25c TELEVISION BLACK-SPOTTER • SIGNAL-TRACING AMPLIFIER
 NADA 30c FLUORESCENT LIGHTING • MARINE RADIO DIRECTION FINDER
 1941

"Finest Dynamic I ever used"
 SAYS EVAN R. RUSHING, SOUND ENGINEER, HOTEL NEW YORKER

AMPERITE
P. G. DYNAMIC
 BRINGS STUDIO QUALITY
 TO ORDINARY P. A. JOBS



- **UNI-DIRECTIONAL.** NEW SUPERIOR ELIPSOID PICKUP PATTERN
- **ELIMINATES FEEDBACK** TROUBLE BECAUSE IT HAS LOWEST FEEDBACK POINT OF ALL DIAPHRAGM TYPE MICROPHONES
- **FLAT RESPONSE.** FREE FROM ANNOYING PEAKS, GIVING STUDIO-QUALITY REPRODUCTION.



The P.G. diaphragm follows air particle velocity where amplitude is a GRADIENT of the PRESSURE. In ordinary dynamics amplitude is restricted from following air particle velocity.

The P.G. DYNAMIC is a radical improvement in this type of microphone. You can actually hear the difference. Case is designed according to modern acoustic principles. Rugged, not affected by temperature, altitude or humidity. HAS UNUSUALLY HIGH OUTPUT, —55 DB.

MODEL PGH (PGL 200 ohms). Excellent for high fidelity P.A. installations, broadcast studio, and professional recording. With switch, cable connector, 25' cable. Chrome finish, LIST \$32.00 (40, 10,000 C.P.S.)
 MODEL PGAH (PGAL 200 ohms). For speech and music. 70-8000 C.P.S. Switch, cable connector, 12' cable. Chrome, LIST \$25.00

**COMBINATION VELOCITY-DYNAMIC
 ACHIEVED WITH
 ACOUSTIC COMPENSATOR**

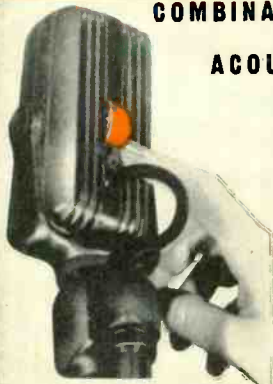

An exclusive Amperite feature: By moving up the Acoustic Compensator you change the AMPERITE VELOCITY to a DYNAMIC microphone without peaks. At the same time you reduce the back pickup, making the microphone practically UNI-DIRECTIONAL.

WITH ACOUSTIC COMPENSATOR:
 MODEL RBHk; RBMk (200 ohms) with switch, cable connector.

Chrome, LIST \$42.00

RSHk; RBSk (200 ohms). Switch, cable connector, Acoustic Compensator.
 Chrome or Gunmetal, LIST \$32.00

AMPERITE KONTAK MIKE
 Puts Musical Instruments Across



So beautiful is the tone produced with the Kontak Mike, that it was used in the Philadelphia Symphony to amplify a mandolin solo. Gives excellent results with any amplifier, radio sets, and record players.

- MODEL SKH (hi-imp) LIST \$12.00
- MODEL KKH, with hand volume control. LIST 18.00
- Plug extra List 1.50
- FOOT PEDAL, for making beautiful crescendos LIST 12.00

WRITE FOR FREE SALES AIDS **AMPERITE Co.** 561 BROADWAY, N. Y. U. S. A.

Specify **AMPERITE**





I Jumped from \$18 a Week to \$50
-a Free Book started me toward this
GOOD PAY JOB IN RADIO

Here's How it Happened

by S.J.E. NAME AND ADDRESS SENT UPON REQUEST



"I had an \$18 a week job in a shoe factory, but desired to make more money and continue my education. I read about Radio Opportunities and enrolled with the National Radio Institute."



"The instruction I received was so practical I was soon able to earn \$5 to \$10 a week in spare time servicing radios. This paid for the N. R. I. Course and led to service work paying for my college education."



"Radio servicing permitted me to attend school and work evenings and week-ends. Upon completing the N. R. I. Course I was made Service Manager at \$40 to \$50 a week, more than twice my shoe factory wage."

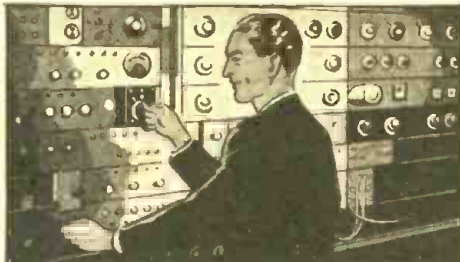

"Later the N. R. I. Graduate Service Department sent me to Station KWCR as a Radio Operator. Now I am Radio Engineer of Station WSUI and connected with Television Station W9XK."

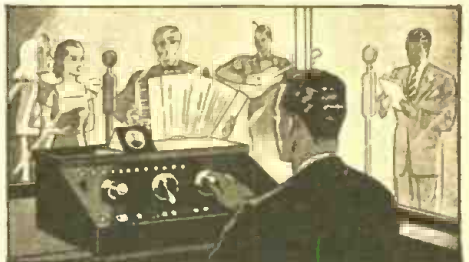

"The N. R. I. Course took me out of a low-pay shoe factory job and put me into Radio at good pay; enabled me to earn funds for a college education. There's a promising future for thoroughly trained Radio men."



J. E. SMITH, President
 National Radio Institute
 Established 25 Years

Find out today how I Train You at Home
to BE A RADIO TECHNICIAN

If you can't see a future in your present job, feel you'll never make much more money; if you're in a seasonal field, subject to lay offs, IT'S TIME NOW to investigate Radio. Trained Radio Technicians make good money, and you don't have

to give up your present job or leave home to learn Radio. I train you at home nights in your spare time.

pay jobs. Radio jobbers, dealers, employ installation and servicemen. Many Radio Technicians open their own Radio sales and repair businesses and make \$30, \$40, \$50 a week. Others hold their regular jobs and make \$5 to \$10 a week fixing Radios in spare time. Automobile, Police, Aviation, Commercial Radio; Loudspeaker Systems, Electronic Devices, are other fields offering opportunities for which N. R. I. gives the required knowledge of Radio. Television promises to open good jobs soon.

you make money fixing Radios while learning and equip you for full time work after you graduate.

Find Out What Radio, Television Offer You—Mail Coupon

Act Today! Mail the coupon for my 64-page book, "Rich Rewards in Radio." It points out Radio's spare time and full time opportunities and those coming in Television; tells about my Course in Radio and Television; shows more than 100 letters from men I have trained, telling what they are doing and earning. Read my money back agreement. Mail COUPON in an envelope or paste on a penny postcard—NOW!

J. E. SMITH, President
 Dept. 1DX, National Radio Institute
 Washington, D. C.

Beginners Quickly Learn to Earn \$5 to \$10 a Week Extra in Spare Time

The day you enroll, I start sending you Extra Money Job Sheets—start showing you how to do Radio repair jobs. Throughout your Course I send plans and directions which have helped many make \$5 to \$10 a week extra in spare time while learning. I send special Radio equipment to conduct experiments and build circuits. This 50-50 training method makes learning at home interesting, fascinating, practical. YOU ALSO GET A MODERN PROFESSIONAL ALL-WAVE SET SERVICING INSTRUMENT to help

MAIL THIS NOW Get 64 Page Book Free

J. E. Smith, President, Dept. 1DX
 National Radio Institute, Washington, D. C.

Mail me FREE, without obligation, your 64-page book "Rich Rewards in Radio." (No salesman will call. Write plainly.)

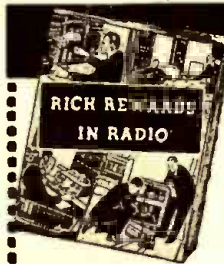

Age.....

Name

Address

City State

Draft Registrants Attention!

Hundreds of men who know Radio when they enter military service are going to win specialist ratings in the Army, Navy and Marine Corps. These ratings pay up to 6 times a private's or seaman's base pay, in addition to carrying extra rank and prestige! If you ARE NOT called, you are getting into Radio when the Government is pouring millions into the Radio industry to buy Defense equipment, on top of boom civilian Radio business. Whether you enlist or wait for conscription—IT'S SMART TO LEARN RADIO—NOW!

The Beginners' Way to Good Pay in Radio

RADIO-CRAFT

HUGO GERNSBACK, *Editor-in-Chief*

N. H. LESSEM
Associate Editor

THOS. D. PENTZ
Art Director

R. D. WASHBURNE, *Managing Editor*

Contents APRIL, 1941 Issue VOLUME XII -- NUMBER 10

Mailbag	579
Editorial: Super Music	Hugo Gernsback 585
The Radio Month in Review	586

RADIO DEFENSE

N.Y.A. Offers Radio Training to America's Youth	588
---	-----

SERVICING

New Circuits in Modern Radio Receivers—No. 43 F. L. Sprayberry	589
Operating Notes	590
Fluorescent Lighting—Latest Sideline for Servicemen—Part III, Installation Design	John T. Bailey 592
RADIO SERVICE DATA SHEETS:	
No. 304—Zenith "Chair-Side" Models 10S531—10S549— 10S566 (Chassis Model 10A1)	594
No. 305—Ditto	595
Servicemen's Deadline—March 29 at 3:00 A.M. (Frequency Reallocations)	603

SOUND

Sound Engineering—No. 16..... Conducted by A. C. Shaney	602
Servicemen's Deadline—March 29 at 3:00 A.M. (Frequency Reallocations)	603
Modern Microphone Technique—Part III, The Microphone in Action	L. Fletcher & H. S. Manney 604

ELECTRONICS

1933 "April Fool" Tube Now a Reality!	R. D. Washburne 610
Build Your Own Experimental Electronic Organ	W. K. Allan 620

TEST INSTRUMENTS

Signal-Tracing Amplifier—An Effective Radio Servicing Tool L. M. Dezettel	596
Modernize Your Tester to Check High-Voltage-Heater Tubes D. J. Foard, E.E.	600

TELEVISION

An Englishman's Home-Built Television Black-Spotter	M. E. Southall 613
---	--------------------

RADIO DEVELOPMENTS

Theater Screen-Size Television	624
--------------------------------------	-----

F.C.C.

Radio Interference from Electromedical Apparatus	627
--	-----

NEXT ISSUE!

- Microphones and How They Work
- Making P.A. Measurements
- Measuring Distortion in A.F. Amplifiers
- Servicing Record Players
- An Ultra-Mobile P.A. System
- Design and Construction of a P.A. - Recording - Radio System—Part I

EXPERIMENTERS

How To Make a Reliable Marine Radio Direction Finder J. M. Binding	616
Build Your Own Experimental Electronic Organ	W. K. Allan 620

DEPARTMENTS, ETC.

Mailbag	579
The Radio Month in Review	586
New Circuits in Modern Radio Receivers—No. 43 F. L. Sprayberry	589
Operating Notes	590
RADIO SERVICE DATA SHEETS (see Servicing)	594, 595
Radio in the Northwest	Roy Carmichael 599
Sound Engineering—No. 16..... Conducted by A. C. Shaney	602
Latest Radio Apparatus	629
Classified Radio Directory—Section I (Revised)	633
Shop Notes—Kinks—Circuits	639
Book Reviews	640



Published by Radcraft Publications, Inc. Publication office: 29 Worthington Street, Springfield, Mass. Editorial and Advertising Offices: 20 Vesey Street, New York City. Chicago Advertising Office: RADIO-CRAFT, 520 North Michigan Avenue, Chicago, Ill.

RADIO-CRAFT is published monthly, on the first of the month preceding that of date; subscription price is \$2.50 per year in U. S. (In foreign countries, 75c additional per year to cover postage; Canada, 50c additional.) Entered at the post office at Springfield as second-class matter under the act of March 3, 1879.



Foreign Agents:

London—Gorrings's American News Agency, 9A Green St., Leicester Square, W. C. 2, England.

Paris—Messageries Dawson, 4 Rue Faubourg, Poissonniere, France.

Melbourne—McGill's Agency, 179 Elizabeth St., Australia.

Dunedin—James Johnston, Ltd., New Zealand.



Text and illustrations of this magazine are copyright and must not be reproduced without permission of the copyright owners.



Copyright 1941 Radcraft Publications, Inc.

ON "WHERE RADIO FAILS"

Dear Editor:

I read with unusual interest your editorial in the January issue of *Radio-Craft* in which you called to the attention of the industry the need for a system of publicizing the radio programs on the air.

This locality was among the first to feel the ax when newspapers and radio stations began falling out. Over 10 years ago, in 1930, I was engineer at one of our local stations. I was also Radio Editor of one of our large daily newspapers. Naturally I was in a position to see both sides of the question. (I set forth these arguments in an article in *Parts* in 1938.) In all fairness I must say that the newspapers were imposed upon, and that they received practically no cooperation from the radio stations. The editor of one of our large dailies told me that after he had devoted thousands of dollars of space to radio programs and news he was sent a bill for the radio station announcing a change in location of a public meeting which he had requested. The editor of the other daily said that he quit cooperating with the radio station because the station's manager refused to instruct his announcers to use the paper's byline when crediting them with news bulletins. In every case it was some silly incident together with selfishness on the part of the station.

However, be this as it may, the need for proper publicity for Radio constitutes an acute problem. The very life line of the industry is the radio audience, and it is only through the spectacular events that have so fortunately occurred that this audience has been kept alive. All Servicemen will agree that before the outbreak of the war, radio servicing had hit an all-time low.

During the past 10 years I have spent much time and money trying to find a solution to the problem of properly publicizing radio programs. For 3 years I published a radio bulletin. I bought space in the newspapers and time on the air. I printed novelties (as you suggest) which I distributed. One was a slide-rule affair with the programs printed on the slide and the time on the cover. The slides could be renewed periodically. I wrote manufacturers and editors in an effort to get some nationally-effective effort started.

And, unless the effort is national, I am thoroughly convinced that it will be useless. From my experience there is only one major way to publicize radio programs, and that is through the daily press. All other systems which I have tried have been more or less failures. People are not going to deliberately read radio programs. As you say it is too much like reading a dictionary. However, if the programs are listed conveniently in the daily newspapers, they will glance over them and their interest is revived if not aroused.

It is my contention that if a listener becomes thoroughly interested in only one radio program, he will keep his radio set in good repair; and will buy another when that one becomes worn out. On the other hand, it is the easiest thing in the world for a listener to lose interest in radio. This can be proved by any Serviceman. When a customer brings his set in for a repair he asks almost invariably, "How soon can I get it?" This shows he is interested in something on the air. But let that radio man keep that set for a week, and it is often months before the owner will return. He has lost interest in the programs because of his being unable to hear them.

This condition has been remedied to a certain extent by the fact that most people have more than one radio set. However, the condition is still there and is of primary importance.

I think that every phase of radio is to blame for the condition that exists between the newspapers and radio. First, the magazines have not done their part in stressing the importance of this phase of the business. Second, the manufacturers have shown a decided disregard. With their advertising power, they could have gone to the newspapers and said, "Look here, if you are to get a large portion of our advertising budget, you must run radio program listings." I wrote manufacturers suggesting this and could get no cooperation. I suggested that the manufacturers have their advertising agencies send out a questionnaire asking if the papers carried radio program listings and making it definite that those which did would be shown partiality. Had this been done years ago, or had the manufacturers had a representative to attend meetings of the newspaper groups and say to them, "You are not hurting the radio stations when you refuse to print their programs, you are hurting us. We are the people who spend money with you. Every bit of advertising that you give to commercial radio programs you are giving to your own customers, because the radio advertisers are also newspaper advertisers and all they are looking for is results," the problem would have been solved.

And, now let's look at the jobber and dealer. These are the fellows that actually place the advertising. They are the ones from whom the newspaper collects its money. Years ago had the magazines and manufacturers started a combined effort to make the jobber and dealer radio program conscious, these fellows could and would have jumped straddle the newspaper men's necks. I personally called on every dealer and jobber in this town and suggested that they ask their newspaper advertising solicitor why his paper didn't carry radio programs. Not one time, but every time he came into their store.

I went to the Servicemen and suggested that they ask their customers to call the newspapers and ask why they didn't print radio programs. I even went to large department stores which sold radio receivers and tried to get them to use their influence.

However, all my efforts were in vain. It seems that no one could see enough immediate personal gain to participate in such a far-reaching venture. I tried to interest tube manufacturers in devoting part of their advertising budget to materials that would help promote radio listening. They are spending the money anyway, why not make the best of it?

Practically all the advertising that is being done in the radio business is of such a selfish, uninteresting nature that it goes unnoticed. It seems that the industry is like a bunch of automobile salesmen in a small town. They will leave no stone unturned to sell one of their competitor's customers, but they will not walk around the corner to try to get a prospect of their own.

If Servicemen would realize that their worst competition is procrastination, and not the man down the street, they would be much better off. There are more radio sets that need work than are working perfectly. To get this work into their shops requires a concentrated drive to make the owner conscious of the good things he is missing by putting off having his set repaired.

From a manufacturer's standpoint, practically no space is being devoted to interest the public in higher-priced radio sets. A large part of all radio advertising is devoted to the \$9.95 type, on which no one can make any money even after it is sold. In an effort to compete with the chain stores, all

240

PAGES, LISTING

9,891

RECEIVER MODELS, MADE BY

224

SET MANUFACTURERS.

In this New



No longer is it necessary to wonder what replacement I-F Transformer to use in any superhet! Just refer to this first complete I-F TRANSFORMER REPLACEMENT MANUAL and you'll have the answer in a jiffy!

Every superhet ever made, on which data could be obtained, is listed by manufacturer and model number; original part numbers on the transformers, original I-F peak frequency AND the number of the Meissner Transformer recommended for replacement—are all given in handy tabular form 210 pages of them! Special connections or service notes are given when necessary.

AND MORE—

Fourteen pages of solid information give the most complete data ever published on the various types of I-F Transformers, their peculiarities of construction, problems met with in servicing and replacing them, elimination of undesirable oscillation and regeneration, and a thorough discussion of all kinds of service problems concerning the I-F Channel. Together with other pages of useful tables and data, this book contains 240 pages in all! It is truly a MANUAL of indispensable information for the serviceman—a tool no modern worker can afford to be without!

Get your copy from your Jobber at once—or send 25c directly to the address below. Your Manual will be mailed to you immediately, postpaid.

Write Today for Free General Catalog

Address Dept. C-4



RADIO TRAINING



PORT ARTHUR COLLEGE—not privately owned, not operated for profit, a college built and endowed by the late capitalist-philanthropist, John W. Gates—offers the most thorough practical Radio training in America. P. A. C. owns Radio Station KPAC, which is equipped with the very latest type 1000-Watt high fidelity RCA transmitter, operating on 1220 kc. with directional antenna system. The college is authorized to teach RCA texts.

The Radio training covers thoroughly Airways, Press, Announcing, Teletype, Typewriting, Laboratory and practical experience at KPAC transmitter, control room and studios. Announcing is an optional part of this training; nevertheless a number of students annually make successful announcers. Port Arthur College pioneered the teaching of radio with its first classes in 1909, and for thirty-one years has maintained an active Employment Bureau that is successful in placing graduates in airways, broadcast and marine radio industries.

If interested in details about the Radio Course, write for Bulletin R-41

PORT ARTHUR COLLEGE
PORT ARTHUR (World-Known Port)
TEXAS

RADIO SERVICE EXPERT LEARN AT HOME IN SPARE TIME

The demand for radio experts grows every day. Learn this paying profession under personal guidance of qualified engineering and educator. Clear, fascinating instruction and experimental kits make learning easy. Leaders in the radio industry endorse R.T.A. methods. Spare time profits soon pay for training.

NOW IS A FINE TIME TO START

New National defense program requires radio trained men in radio factories and every branch of U. S. Service. Opportunities for advancement almost limitless.

FREE Write today for complete information and radio book telling what R.T.A. training can do for you.

RADIO TRAINING ASS'N. OF AMERICA
1559 Devon Ave. Dept. RC-41 Chicago, Ill.

Correspondence Courses in RADIO and ELECTRICAL ENGINEERING

ELECTRICAL ENGINEERING Get good grasp of wide electric field. Prepare yourself, at Low Cost, for secure future. Modern, simplified, you can understand quickly.
RADIO ENGINEERING Extra fine course in radio, public address, photo-electric work.
Trains you to be super-service man, real vacuum tube technician. Exper. kits furnished. Diploma on completion. Tuition, \$25, either course. Deferred payment plan.
FREE Get copies of school catalogs, student magazines, complete details. SEND NOW!

LINCOLN ENGINEERING SCHOOL, Box 931-C28, LINCOLN, NEBR.

RADIO TECHNOLOGY



RCA Institutes offer an intensive course of high standard embracing all phases of Radio and Television. Practical training with modern equipment at New York and Chicago schools. Also specialized courses in Aviation Communications, Radio Servicing and Commercial Operating. Catalog Dept. RC-41.

RCA INSTITUTES, Inc.

A Radio Corporation of America Service
75 Varick St., New York, 1154 Merchandise Mart, Chicago

RADIO-TELEVISION

Oldest, largest Radio-Television school in West trains you for good pay job. Complete instruction including Radio Construction and Service, Broadcast Operating, Sound, Talking Pictures, Television, Public Address, etc. Flexible plan to meet specific needs of those with or without jobs. Transportation allowed to L.A. Earn room and board while learning. Request Free Catalog.

NATIONAL SCHOOLS, Dept. 4-RC
Los Angeles

sense of quality and the fine things in life have been forgotten.

Almost daily, every radioman gets calls from his friends asking what make radio should they buy. This alone proves my point. No single manufacturer has put enough thought into his advertising to lift him above the masses in his business. No one has made a bid for the business of the man who is not looking for something cheap—and believe me, there are plenty of these. However, in this day of chiseling he is the forgotten man. Even if he pays a high price for a radio receiver, all that he gets is more junk—more tubes to replace, more condensers to short and more knobs to lose the springs out of.

(In view of the fact that radio manufacturing today is a highly competitive field, we question this contention of Mr. Davis. In other words, there must be a reason for the higher prices charged for certain radio receivers, else no manufacturer could sell his higher-priced products; a radio set must afford certain definite facilities and new improvements for any given increase in price. In other words the increase in price is more than just a matter of adding components. What about engineering laboratory expenses, patent costs, increased cost of production, added merchandising costs, etc., all to make available and "put over" new conveniences and facilities in receiver operation?—Editor)

Seriously, it appears to me that what the industry needs is coordination, a combined effort on the part of all concerned to do their part in accomplishing the desired results. If this were done we could lick this and every other problem.

My suggestion is that the industry appoint some one to go to the newspapers and ask that the rate on radio advertising of all types be increased to a figure that will permit the paper to give space to program listings. If this were done, every phase of the industry would pay its part. The manufacturer, jobber, dealer, Serviceman, radio program sponsor and everyone else who placed advertising pertaining to radio would have to pay this higher rate. This would compensate the newspapers, and without some compensation it is my belief that radio programs will never again be published in all the papers.

HAROLD DAVIS,
Jackson, Miss.

ANENT HOMER BUCK'S "ALIGNING SUPERHETS."

Dear Editor:

I take exception to the article by Homer C. Buck, re: "Aligning Superheterodyne Receivers," January *Radio-Craft*.

"After aligning receivers with recognized aligning equipment we have found that the I.F.s were off as much as 3%. Servicemen who are accustomed to tolerances of 15 and 20% will say that a deviation of 3% is darn near perfect . . ."

Where does Mr. Buck derive his figures? Why, they seem to be ridiculous. If we figure 3% of 455 kc., a standard I.F., the answer is 13.65 kc. deviation. If we figure 20%, the deviation is 91 kc., and I for one do not believe any legitimate Serviceman would align a set with the I.F. that far away from the correct figure.

Furthermore, while his arithmetic is good, his common sense and understanding of service procedure is all cockeyed if he is ready to believe that any busy and successful Serviceman has either the time or inclination to indulge in fancy image hunts and sliderule calculations.

In my own alignment work, for sets not requiring a flat-top I.F. curve, I use the standard method of alignment, with my

I.F. derived from an oscillator accurate to better than 1 part in 9,000 or 0.0001-per cent of 455 kc. The 2nd-harmonic of the oscillator, an electron-coupled commercial job, is beat against a broadcast station frequency accurate to 20 cycles of the assigned carrier frequency. The oscillator is adjusted, by a trimmer, whenever necessary, and hardly ever shifts, even after warming up. The oscillator is a Philco 088, A.C. job.

More on Mr. Buck next month.

WILLARD MOODY,
New York, N. Y.

FROM A CHINESE READER

Dear Editor:

There are many Chinese readers of your excellent magazine, perhaps I am the only one that writes to you.

The article "Servicing R. F. Coils" (Vol. XI, No. 12) has errors in it. Fig. 7B is Fig. 7C, and vice versa.

This article has been translated into Chinese by me, and will be published in the July issue of "Popular Radio Magazine," one of the two well-known Chinese radio magazines.

The best of my wishes,
K. C. WU, Shanghai, China

Mr. Wu may be interested to know that *Radio-Craft* has other correspondents from the Orient, and last week, a visitor, Mr. Fred Shunaman, who operates a radio service station on Bubbling Well Road in Shanghai.—Editor

SOUND IS BOOMING! . . .

. . . so Radio-Craft goes to town

The May issue of RADIO-CRAFT will be a "Sound Special." Home Recording and Phono-Radio Combinations have taken the public by storm, so RADIO-CRAFT is going to town! The May Issue will be devoted mainly to Sound. This, of course, includes public address as well as home recording and phono-radio combinations.

In addition to the usual departments on this topic, there will be special articles and construction projects which will be of considerable value to Servicemen, Sound Specialists, and radio men in general;—not the ordinary run of articles but specially-prepared material for this issue.

Reserve your copy NOW!

PROGRESS DESPITE HANDICAPS

Editor's Note: Last year Mr. R. J. Schoonmaker sent us a photo (Fig. A.) of the radio service shop he was starting. We did not publish the photo at the time because the shop seemed to be too incomplete. Recently we asked Mr. Schoonmaker how he was getting along. His interesting reply follows:

Dear Editor:

OK, you asked for it, here it is. I believe I have made fair progress during the past year, all things being considered.

Naturally you do not know what that above expression includes.

However, to be brief, I am a widower, with 6 children to bring up, house work to do, home to look after, am partially deaf (I appreciate what Earl Russell of Colfax, Ill. [Feb. '41 "R.-C."], is up against) and I have to put in long hours to accomplish anything. Considering the above handicaps I believe you will agree that I have not done bad. I am up against 3 well-established

RADIO SERVICE MEN! HAMS! SOUND MEN!

GET THESE BIG CATALOGS **FREE!**

Because there's a Sears Mail Order House right near you, you make big savings on transportation costs by buying from Sears

Our catalog of Amateur and Service Supplies contains a most complete selection . . . everything you could possibly want! By ordering from your nearest Sears Mail Order House you save real money on transportation costs. As a rule, orders are filled same day received. Everything money-back guaranteed . . . and Sears Easy Payment plan is an easy way to buy! Write for this book today . . . A postal card will do . . . ask for Catalog RC717A.

SEARS, ROEBUCK and CO.

Chicago, Philadelphia, Boston, Kansas City, Minneapolis, Atlanta, Memphis, Dallas, Seattle, Los Angeles

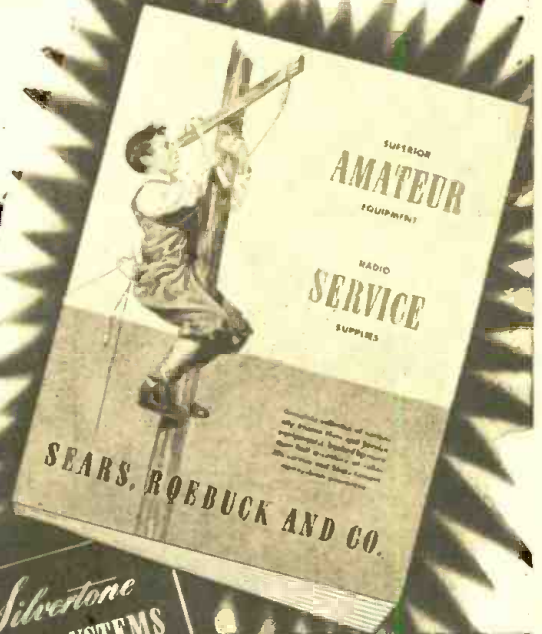

Attention PUBLIC ADDRESS USERS!

Prominent Public Address users and Rental outfits have found it pays big dividends to get their equipment from Sears. Latest equipment at amazingly low prices—and you save Real Money on shipping charges! Get this big book today . . . Write for RC732A.

Servicemen, 2 of whom have been in the game here for 20 years. OK, maybe I have a h--l of a nerve trying to take work away from them, but I'm getting my share of it gradually. I make it a practice to satisfy the customer, even if at a loss to me at times, and they come back.

You will notice, by comparing the first photo I sent you, with the one I am mailing you now (Fig. B), that I have invested quite a sum in Service Info alone, besides gradually replacing the home-made equipment with more accurate ones. Also the lumber I used for all the construction, amounts to quite a bit. Of course I did the carpenter work, such as it is. I need not tell you, I suppose, that I copied the main idea for the new bench, from W8QNU's article on his bench (March '40 "R.-C.").

I, also, like Earl Russell, intend to build

up a hearing-aid as soon as I can spare the money for parts, and then drum up some business with it. On a separate sheet you will find a description (reproduced below—Ed.) of the new bench.

DESCRIPTION OF SERVICE BENCH

Upper-left panel.—Analyzer (designed and built by me). To the right of Analyzer.—Triplett 1200A. Left-center panel.—Upper-left corner: 1-watt neon night light. Lower-left corner: switch for above. Next to switch: (See Note I.) Lower-right corner: 2-circuit switch controlling the 3 mazda lamps in reflector above. Upper-center: hand-drawn chart for measuring capacity of condensers, through the 1200A. Lower-center: switch and pilot light, controlling a row of receptacles at rear of panels. The

servicing instruments are plugged into these and the circuit is fused lightly, for instrument protection. Below-center: quintet antenna and ground outlets. The glass-framed item is my R.M.S. Certificate. Right-center panel.—Another 1-watt neon night light. Also another hand-drawn graph for testing condensers. Shelf above books is tube rack.

Upper-right panel.—Webber Tube Tester, model 200. Panel to left of this.—Tube chart for above. Lower-left panel.—Philco Signal Generator. (The light above it is a 25-W. showcase lamp, in a nickel reflector.) Next panel.—Condenser tester (home-made). Next to this is a Rube Goldberg idea. The banana jacks give straight 110 V. A.C. or (by means of the rheo.) 6 to 24 V. A.C., for working on electric trains, etc.

Lower-right panel.—Auxiliary tuner for sets with dead ones. I left the set on the

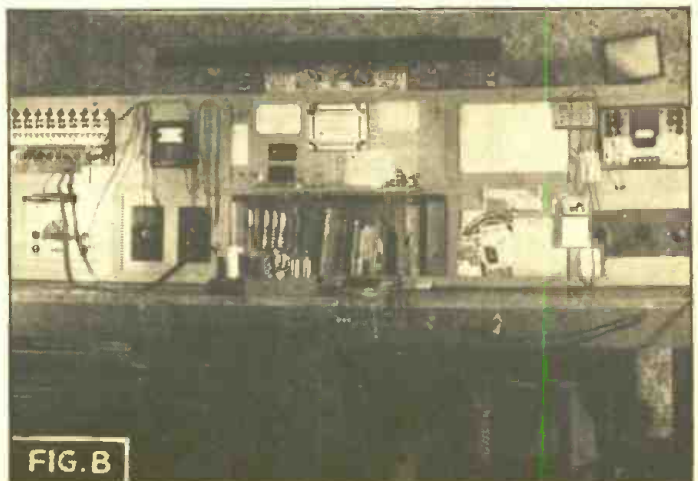
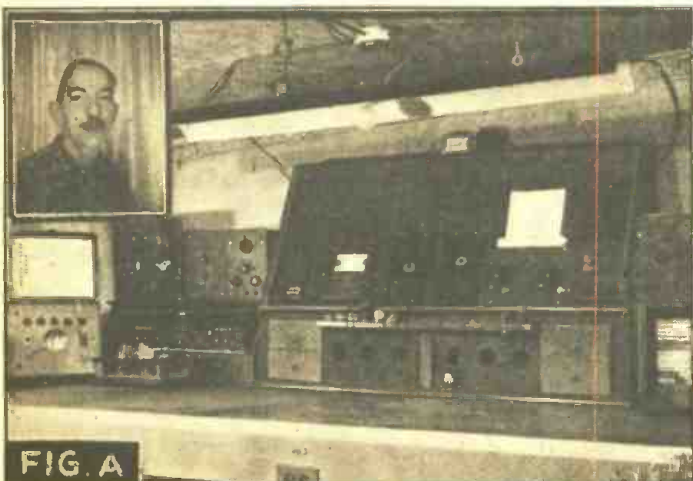

Serviceman Schoonmaker's (See insert photo, upper-left in Fig. A.) service shop last year (Fig. A.) and as it is today (Fig. B.). Read Mr. Schoonmaker's letter "Progress Despite Handicaps."

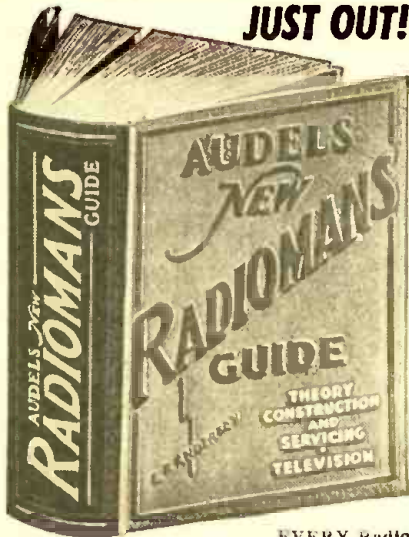

JUST OUT!

RADIO

EVERY Radio Mechanic—Service Man & Student Needs "Audels Radiomans Guide"—Just Out!

The whole subject of Modern Radio—covering the Basic Principles—Construction & Operation—Service—Repairs—Troubles—All Easily Understood. Over 750 Pages, 400 Illustrations, Parts & Diagrams—LATE TELEVISION DATA—Valuable for REFERENCE AND HOME STUDY.

To get this practical information in handy form for yourself fill in and mail coupon today.
4 COMPLETE • PAY ONLY \$1 A MO.
 AUDEL Publishers, 49 W. 23rd St., N. Y.
 Mail AUDELS NEW RADIOMANS GUIDE for free examination. If O. K., I will send you \$1 in 7 days; then remit \$1 monthly until price of \$4 is paid. Otherwise, I will return it.
 Name.....
 Address.....
 Occupation.....
 Reference..... RCF

Are You Playing

"BLIND MAN'S BUFF"

With Your Future?



Are you, like so many other professional radiomen, aimlessly groping for the door to opportunity? Thousands of ambitious radiomen have been set on the right course with the help of CREI advanced technical training. The well-written text plus the personalized training provides a proven formula for more rapid advancement.

CREI graduates as a group are among the highest paid in radio—69% (by actual survey) enjoy salary increases! Year after year we strive to improve our courses and the results they enable you to enjoy. Why not investigate what CREI training in Practical Radio Engineering can do for YOU?

Write for Facts Today —

Send for our interesting booklet, together with personal recommendations for your advancement in radio. To help us intelligently answer your inquiry, please state briefly your education, radio experience and present position; also whether interested in home study or residence training.

CAPITOL RADIO
 Engineering Institute
 Dept. RC-4, 3224 16th Street, N.W., Washington, D. C.



bech to show you how handy my analyzer is, in spite of Signal Tracing, Signal Substitution, Audolyzing, Veedolyzing, or what have you. I am now working, in my spare time, on the Signal Tracer by Monroe H. Freedman (Sept. '40 "R.-C."). I believe it will be quite a help to speed up my work.

Note I.—This is a little contraption of my own. As I cannot depend on myself to hear the doorbell, I watch this while I am working. I simply connected a second bell transformer to my first one as follows. Where the secondary of the 1st transformer feeds the bell circuit, I connected the secondary of the 2nd transformer, then the primary of the 2nd transformer feeds the 110-V. neon bulb, which flashes when the bell rings.

If any of you boys are interested in my analyzer (I know thousands of them have been designed and published) I will be glad to send the Ed. the dope on it.

Incidentally, the panels are plywood finished in slate gray, and the striping in between is bright orange.

R. J. SCHOONMAKER,
 Port Jervis, N. Y.

RE. WILLARD MOODY'S LETTER

Dear Editor:

After reading Willard Moody's letter in the Feb. '41 issue, I decided to write, myself. I quite agree with him on some points, not all. I like your editorials and I can't see much wrong with the cover but I don't think that most readers get much out of the Radio Month in Review or the hints and kinks features. I like the Operating Notes and the Data Sheets and think we should have more of them. And if you are going to have full-page ads to sell Radio-Craft for premiums let's have premiums that are of value or at least change them once in a while.

Of course it is hard to please everyone, I know because I have been a Serviceman for many years and somebody is always displeased with what we do.

I have been a newsstand reader of Radio-Craft for a long time and think it is hard to beat for the Serviceman. (Thank you!—Editor)

CHRIS. NEEDLES,
 Missoula, Montana.

Dear Editor:

I have been a pardner of yours since 'way back when. Always a silent pardner until now, for you were doing your best to give me what I wanted and that is pretty much what I was getting. There wasn't any need for words, so there were no words. Simple.

But I must now bust out with the plea that you take Willard Moody kinda un-serious.

He has likely just finished a correspondence course and has a nice new diploma showing that he now is a Master of Constructive Thinking, so he decides to remodel Radio-Craft and show us how much better it is under the sway of his genius.

I don't know his age, but I can guess. Only the very young can be so damn sure of themselves. However, he is not so important, it is his plan that is to be considered. I see it thusly:

- (1) The cover. I don't care. I am so anxious to see what is inside that the cover gets scant attention from me.
- (2) The tiresome Gernsback editorials. They have broadened the mental horizons for thousands of us and sometimes contain usable ideas. Most of us radiomets would be very unhappy if they were left out.
- (3) Radio in Review. He must have

DATAPRINTS



TESLA-LOUDIN COILS

- 20c Ea. in order for 10 (Data and Drawings only.)
- 36" Sp'k Tesla-Oudin Coil 40c (1 K.W. Exc. Trf. Data incl.)
- 8" Sp'k Tesla-Oudin Coil 40c (1/4 K.W. Exc. Trf. Data incl.)
- 8" Sp'k Oudin; 110 Vt. "Kick Coil" type.....40c
- 3" Tesla Works on Ford Coil40c
- 1" Sp'k Vibrator Hi-Freq. Coil 40c

NEW! 5 ft. Sp'k. Oudin Coil & Exciter Data75c

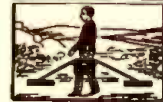

Induction PIPE & ORE LOCATOR

Induction Type, Data40c
 Radio Type40c

More DATAPRINTS 40c each!

- 5 Meter Superhet.
- 1/2 Meter Tr. & Rec.
- 20 A.C. Probs. & Ans.
- 20 Telephone Hook-ups
- 100 Mech. Movements
- 20 Motor Hook-ups
- Television Hook-up
- 20 Elec. Party Tricks
- Solenoids and Magnets—get list.
- Fry Eggs on Icel
- Experimental Telephone
- Radio Control for Models
- Diathermy Apparatus
- Inductor Organ
- Electric Refrigerator
- Wheatstone Bridge
- Weld. Transf. 2 K.W.
- Rewinding Armatures
- String Galvanometer
- 20 Simple Bell Circuits
- Steel Wire Recorder!
- Water Wheels
- Water Turbines
- Photo Cell and Relay
- Ring 4 bells; 2 Wires
- 20 Tesla Tricks
- Polarized Relay
- Induction Balance
- Electric Pipe Thawer

Special Prices: 4 prints \$1.00; 10 for \$2.00; Single, 40c each. Get New Catalog 100 A.

The DATAPRINT Co.
 Lock Box 322D, Ramsey, N. J.



ELEMENTARY MATHEMATICS

• EASY — SIMPLIFIED — PRACTICAL •

HERE is a book for the business man, the technician and craftsman explaining and answering every operation and meaning with interpreting illustrations and examples. It is the key to a simple understanding of many perplexing problems in daily life. In clear, positive and definite language, the author popularizes and clarifies every subject and helps the reader to overcome any apparent difficulty in the study of mathematics. A real home study-course in mathematics for the student or the man who wants to achieve proficiency or desires to brush-up on his knowledge. Entire Chapter on Special Mathematics for the Radio Technician.

CONTENTS OF BOOK

- CHAPTER I. Arithmetic—Addition—Subtraction—Multiplication—Division.
- CHAPTER II. Factoring and Cancellation—Fractions—Decimals—Percentage—Ratio—and Proportion.
- CHAPTER III. The Metric System.
- CHAPTER IV. How to Measure Surfaces and Capacity (Geometry).
- CHAPTER V. Powers and Involutions—Roots and Evolution.
- CHAPTER VI. Mathematics for the Manual and Technical Craftman—Thermometer conversions—Graphs or Curve Plotting—Logarithms—Use of the Slide Rule.
- CHAPTER VII. Special Mathematics for the Radio Technician.
- CHAPTER VIII. Commercial Calculations—Interests—Discounts—Short Cut Arithmetic.
- CHAPTER IX. Weights and Measures—Useful Tables.

ONLY 50c POSTPAID

Elementary Mathematics can be carried readily in your pocket. Send Stamps, Cash or Money Order.

TECHNIFAX

1917 S. State St. RC-441 Chicago, Ill.

PATENTS—TRADE MARKS

Booklet concerning Inventions & Patents Form "Evidence of Conception" with instructions for use and "Schedule of Government and Attorneys Fees"—Free
LANCASTER, ALLWINE & ROMMEL
 Registered Patent Attorneys.
 436 Bowen Bldg. Washington, D. C.

FACTORY-TO-YOU SAVE UP TO 50%
 PUT THIS NEW 1941 15-TUBE RADIO-PHONO COMBINATION CHASSIS IN YOUR PRESENT CABINET ONLY \$22.50
 COMPLETE RADIO-PHONO CHASSIS WITH TUBES and SPEAKER UP TO \$25 TRADE-IN (on Many Models)
 30 DAYS TRIAL EASY TERMS Write for FREE catalog today. Dept. 12-HH MIDWEST RADIO CORPORATION, Cincinnati, Ohio. HOME RECORDER FREE

strained himself thinking that one up. We like it.

(4) Sprayberry OK, not any more OK than your other features, but OK.

(5) Nice large generalities. All right by me—whatever they mean.

(6) Ha! Ha! Remember when "Radio News" tried that, about 1937, and how hard they worked to get back their own bunch afterward?

(7) He recommends no attainable change here.

(8) Hints and kinks mean nothing to me, but a lot of your readers like them. Their money is good too.

(9) Us "dopey" Servicemen are the ones who keep you eating regular as you very well know. You aren't apt to take him seriously on that one. And when he has serviced enough thousands of sets, he will be a "dopey" Serviceman too, and will be glad you didn't change.

(10) Seems like you answer that one in most every issue.

I suppose that Letters are a waste of space, but he reads them and adds to something he disapproves of by writing. I read them or I wouldn't have found his letter. It's a sort of meeting place for the gang and probably well liked.

The kid means well. I remember when I, too, felt able to run the World with one hand tied behind me, and do a better job than was being done. But I've grown up since then, even as he will grow.

And if he sees his letter 30 years from now, he will turn the same color that I do when I am reminded of the days of my infallibility.

Ever of thee,
CHARLES PILGRIM,
Aitkin, Minn.

Dear Editor:

I can't agree with Mr. Willard Moody of New York for his comments in the Feb., 1941, issue of *Radio-Craft*.

I think he had a bone to pick with someone and took it out on the Editor and R.-C., I think the Editorials are fine stuff. It gives the radio man something to think about. It's food for thought (even for a Philadelphia lawyer like Mr. Moody). Keep up the good work, Mr. Gernsback.

I see nothing wrong with any of the covers of R.-C. It's a radio magazine.

What's the matter with foreign methods? Myself and others like to know what the other fellow is doing. Our foreign friends read R.-C. as well as us in America.

Keep Sprayberry. Yes, keep Sprayberry and keep R.-C. as it is . . . its service for the radio Serviceman and technician. So keep up the good work in R.-C.—it's a gift at any price!

ALBERT RINGROSE,
Windsor, Ont., Canada.

P.S.—It's a wonder Mr. Moody didn't kick at R.-C. being streamlined.

Thanks very much for your evaluation of *Radio-Craft*, Mr. Ringrose, and you, Mr. Pilgrim. We hope the magazine will continue to merit such high praise.—Editor

TUNING I.F.s BY EAR

Dear Editor:

I received a letter from a fellow by the name of Walker. He said he had an A.C.-D.C. set with an I.F. of 456 kc. and when in Ontario he could receive the Detroit police and WJBK together at 1,500 kc. Both WJBK and the police, WCK, would drift up and down the dial, about 10 kc. either way. I gather there was no distortion when these stations were tuned-in at the new setting, and the rest of the band was OK, WCK being an image of course.

RADIO-CRAFT for APRIL, 1941

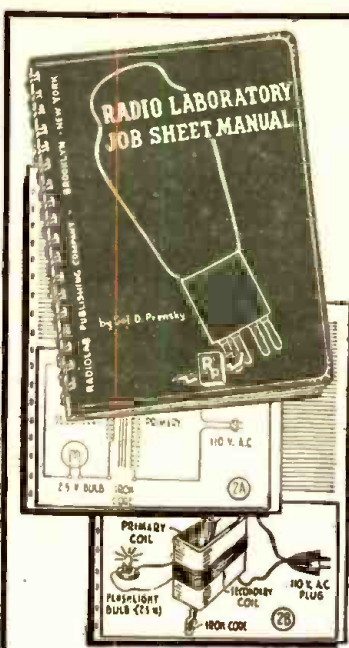

LEARN BY DOING!

Just Published

RADIO LABORATORY JOB SHEET MANUAL

by Sol D. Prenskey

The manual contains 24 practical radio projects arranged to explain and illustrate the fundamentals of radio, with definite layout instructions. It consists of about 83 pages, wire bound, with over 100 illustrations. It is especially adapted for school laboratory work of a basic course in Practical Radio. An educational discount of 20% on orders of six or more. List Price \$1.80

FREE! Write for Circular RLJ, and obtain a complimentary copy of a comprehensive RADIO SYMBOL CHART, including the Continental Code, and Resistor and Condenser Color Codes.

SEND 10c IN COIN for deposit, if you wish a copy of the manual sent to you C.O.D. You pay the balance, plus a small Post Office collection charge.

RADIOLAB PUBLISHING CO., 652 Montgomery St., Brooklyn, N. Y.

I shall attempt to figure it out. While it is entirely possible to align these cheap receivers by ear—much more accurately, in most cases, than by using equipment—it is also possible to get into a lot of trouble without a set of rules to go by and a little practice.

While at 456 kc. the band width of an I.F. transformer may be 8 to 15 kc. wide, the same transformer when tuned to a lower frequency, with the latitude of the trimmers determining the value, will pass a much wider band of frequencies due to deflation of the response curve. The higher the frequency to which a coil is tuned the sharper will be the response.

Therefore, when an I.F. transformer is tuned by ear it is entirely possible to tune to a frequency other than the correct I.F., or some value which is an even or odd part of the correct value, and as long as the latitude of the oscillator trimmer will permit this, some semblance of tracking will occur.

In this particular case, I believe, the I.F. transformers have been tuned to a lower frequency, with the resultant broad response. Any slight drift of the oscillator will cause a station to move from the correct dial setting, and if the I.F. response is broad enough the station may be tuned-in at the new setting with little or no noticeable side-band cutting.

Also, in case some one should try to correct me on the frequency of WCK, the Detroit police, the correct frequency is 2,414 kc. and they should come in at 1,502 kc. as an image, on cheap receivers.

H. C. BUCK,
Detroit, Mich.

ELECTRONIC GUNS

Manufacturers have pepped-up the electronic shooting range described in this magazine some time ago, so that new electronic "sub-machineguns" lay down a barrage of 100 "shots" in 15 seconds. How about using them for preliminary Army target-shooting practice? A lightbeam is lots less expensive than regulation bullets!



LEARN RADIO
SERVICING COURSE—8 WEEKS
OPERATING ^{INCLUDES STARTING}—5 MONTHS

H. C. Lewis
I'LL FINANCE YOUR TRAINING

Mail coupon today for free book showing how you can learn Radio Operating, Servicing, Sound and Television in a few short weeks in Coyne Shops and also how you can pay tuition in easy monthly payments after graduation.

LEARN BY DOING
On real Radio receiving and transmitting equipment at Coyne. Simple, easy method of practical shop training. You don't need previous experience. Prepare for Radio Operators' Government license Exam, and for good jobs in Broadcast, Police Radio, Aircraft Radio, Ships, Commercial Radio stations, or in service shops and radio factories. "Learn by doing", the quick, modern way, at Coyne Shops in Chicago.

EARN WHILE LEARNING
Job Help After Graduation
We assist you in getting part-time work to help pay living expenses and give you real employment service after you graduate.

H. C. LEWIS, Pres., COYNE RADIO SCHOOL,
800 So. Paulina St., Dept. 4124, Chicago, Ill.
Please send me your free book and details of easy Pay-After-Graduation Plan.

NAME _____
ADDRESS _____
CITY _____ STATE _____

RADIO OPERATORS WANTED

The National Defense Program is creating innumerable openings for Commercial Radio Operators—Now is the time to capitalize on your radio training and experience by obtaining a Commercial Radio Operator's License and taking advantage of the many opportunities presented. My recent publication "RADIO OPERATORS' LICENSE GUIDE" has been especially prepared as a Guide for those radio men having the necessary training and experience but who are unaware of the exact requirements for a Commercial Radio Operator's License. Containing over 1,250 questions and answers to the new type examinations, it will enable you to successfully pass the examinations.

Only \$3.00 Postpaid—Send check or Money Order.

WAYNE MILLER
205 West Wacker Drive
Chicago, Illinois

For Better Servicing - For Bigger Profits -

FOR A WIDER KNOWLEDGE OF TECHNICAL SUBJECTS, READ THE

BOOKS IN THE RADIO-CRAFT LIBRARY SERIES

GET into the swing of reading instructive, authoritative books on technical subjects—Radio, Air Conditioning and Refrigeration. The RADIO-CRAFT LIBRARY SERIES is the most complete set of volumes individually treating all important divisions in these fields. Each book has been written for the purpose of giving you the opportunity to specialize in one or more of the popular branches of the various subjects and we know of no easier, quicker or less expensive way to improve your knowledge. The material in each book is very helpful—you'll find them valuable in your work. The authors are all well known and are authorities on the subjects on which they have written. This is the first time that you are enabled to build a library of technical books by such popular writers.

ALL BOOKS ARE UNIFORM

The books in the RADIO-CRAFT LIBRARY SERIES are all uniform. The size is 6 x 9 inches. Each volume contains 64 pages and an average of 50 to 150 photographic illustrations and diagrams. The books are printed on an excellent grade of book paper and have stiff flexible covers. PRICE 50c PER BOOK. All books are sent postpaid.

 <p>Book No. 13 ABC OF AIR CONDITIONING An accurate simplified technical review of the fundamentals of this latest branch of engineering, including servicing data on present-day units. By Paul D. Harrigan. 50c</p>	 <p>Book No. 17 SERVICING WITH SET ANALYZERS A Study of the Theory and Proper Application of Modern Set Analyzers and Associated Apparatus. By H. G. McEntee. 50c</p>
 <p>Book No. 14 POCKET RADIO GUIDE Edited by N. H. Lessem. Handy Reference Book for Radio Men—Set Construction Articles—Audio Amplifier Circuits—Useful Radio Formulas and Data—Handy Short-Cuts. 50c</p>	 <p>Book No. 18 POINT-TO-POINT RESISTANCE ANALYSIS For Service Men Theory—and Application of this Modern Test Procedure to Everyday Radio Service Problems. By Bertram M. Freed. 50c</p>
 <p>Book No. 15 ABC OF REFRIGERATION A carefully written volume, starting with the basic principles of refrigeration by mechanical means, and leading up to a complete analysis of the servicing of commercially available units. By Traiton Mason. 50c</p>	 <p>Book No. 21 BREAKING INTO RADIO SERVICING Simple Instructions and Procedure for Starting a Profitable Radio Servicing Business of Your Own. By Robert Eichberg. 50c</p>
 <p>Book No. 16 PRACTICAL RADIO CIRCUITS A Comprehensive Guide to All Types of Radio Circuits for the Serviceman, Constructor and Experimenter. By David Bellare. 50c</p>	 <p>Book No. 19 PRACTICAL RADIO KINKS AND SHORT CUTS The contents of this book have been planned with the view to help Radio Dealers, Servicemen, Experimenters and Set Builders. By B. Baker Bryant. 50c</p>
 <p>Book No. 20 THE CATHODE-RAY OSCILLOSCOPE Theory and Function, Power Supplies and Associated Circuits, Sweep Circuits, Operation of Typical Unit, Methods of Measurement, Practical Applications of C.R. Oscillographs. By Charles Sicuranza. 50c</p>	 <p>Book No. 22 NEW RADIO QUESTIONS AND ANSWERS Answers to Questions Most Frequently Asked by Both Novices and Experts. By Robert Eichberg. 50c</p>
 <p>Book No. 23 PRACTICAL PUBLIC ADDRESS Modern Methods of Servicing and Installing Public Address Equipment. By B. Baker Bryant. 50c</p>	 <p>Book No. 24 AUTOMOBILE RADIO PRINCIPLES AND PRACTICE A Complete Treatise on the Subject Covering All Phases from Installing to Servicing and Maintenance. By B. Baker Bryant. 50c</p>

New titles are constantly being added to the RADIO-CRAFT LIBRARY SERIES. But, on the other hand, stocks of certain titles are running low, and they may not be reprinted for some time. We would therefore suggest that at this time you order as many different titles as you are interested in. Remember, that if you delay, some of the books may later be out of print.

RADCRAFT PUBLICATIONS, Inc., 20 VESEY ST., NEW YORK, N. Y.
Gentlemen: Enclosed find my remittance of \$..... for which send me, POSTPAID, the Books indicated below.

RADIO-CRAFT LIBRARY SERIES @ 50c EACH
Circle book numbers wanted: 13 14 15 16 17 18 19 20 21 22 23 24

Name Address

City State

(Send remittance in form of check or money order; register your letter if you send cash or unused U. S. Postage Stamps.) RC-441

USE THIS HANDY COUPON WHEN ORDERING

RADCRAFT PUBLICATIONS, Inc.
20 VESEY STREET NEW YORK, N. Y.

RADIO-CRAFT

"RADIO'S GREATEST MAGAZINE"

SUPER MUSIC

By the Editor — HUGO GERNSBACK

. . . . existing means of producing music may one day result in heretofore unheard of musical effects

VERY frequently it is necessary that we humans be reminded that our supposed far-famed technical progress leaves much to be desired.

Ever so often we find that in its evolutionary processes, Nature is not a poor technician; quite the contrary, it often far exceeds our best efforts. Thus, for instance if proof is wanted, our present television efforts are puny compared with real television in full colors, which has been in existence for several billions of years. I refer to the *animal eye* which so far has not been remotely approached in its abilities by the achievements of any television engineer or physicist.

Coming down to simpler things, we pat ourselves on the backs and really believe that our present loudspeakers, for instance, are the acme of perfection and efficiency. Yet, they are exceedingly crude; and as far as efficiency is concerned, why, that doesn't even exist. If you wish proof, it would not be a bad idea to spend a few evenings, weeks, or months in investigating a really efficient sound reproducing instrument which also has existed for at least 2 billion years. I refer to the lowly *cricket* which should constantly be before our sound engineers as a goal to achieve in efficiency. With a microscopical amount of power, the cricket manages to broadcast sounds which on a quiet evening can be easily heard for more than a mile. Let our acoustical engineers try and duplicate this result with the best loudspeaker using the same amount of power, and they will find that the cricket is far ahead, at least where efficiency is concerned.

Coming down to a more or less modern human achievement, we find the thing called Music. Not that music is anything particularly new on this planet because insects and birds had music ages ago. Modern music as we know it today may be called a rather new achievement on this planet. It is so new, in fact, that we often wonder what music has in store for us in the future. Only very recently, for instance, we discovered electronic music through the medium of the vacuum tube. Before that time, nearly all music was of the mechanical kind and in some cases, of the electrical variety.

There are, however, many other musical developments possible and feasible, a number of which are even now taking shape.

Music may be described as harmonious sound vibrations which impinge on our auditory diaphragm. From that point on, through complex processes, what we know as music, is conveyed to the inner brain. What the brain does then is something we know little about. Thus, it is quite certain that a dog or a cat *hears* music as well as we do, but the translation of the musical impulses inside of the brain differs in the human being from that of animals, so that whereas the human may derive pleasure from a musical composition, animals usually do not.

Nor is it necessary that musical vibrations strike our ear diaphragms from the outside. It can be done from the *inside* out just as well. I demonstrated this in the pioneer electrical bone-conduction instrument which I patented many years ago and which I called the "*Osophone*". The Osophone, the forerunner of

all bone-conduction instruments for the deaf, is taken between the teeth while its electromagnet connects to your radio or microphone. The Osophone fills your entire head with music—if necessary—with terrific volume. Yet a person standing 2 feet away from you will hear nothing. In other words, *the music originates within your head* and remains there. It does not take a very vivid imagination to picture a special type of Klystron (high-power generator—of energy), by means of which sound vibrations can be set up in the human body without any visible connection at all. In this manner, the entire body, particularly the bony frame, could be vibrated and impart music *within us*. This could be done by sonorous-sympathetic vibrations which could be set up within the bony frame of the individual.

Those who are doubtful of this should know that it is possible for musical sounds to achieve power of rather large proportions. Thus, a violinist can shatter drinking glasses or window panes at a distance simply by playing the fundamental note of the glass or window pane. It has been said that a violinist could shatter the Empire State Building if he could sound its fundamental note over a period of time. None of these things have been sufficiently exploited as far as modern music is concerned and now that we have it within our reach to generate sounds of almost any desired intensity, it is certain that there will be a tremendous new development in music in the future.

Molecular music is another subject which as yet has not been exploited at all. Years ago, it was discovered that it is possible to make dynamos sing or talk by merely vibrating the dynamo's molecules. In this case, nothing moves. There are no diaphragms, no loudspeakers, but the entire iron frame of the machine gives forth sounds, speech or music.

I can visualize, therefore, a future all-steel auditorium giving forth Super-music by energizing the entire auditorium in such a manner that the walls, ceiling and floor will have its molecules vibrated. Entirely new effects even undreamed of today will thus be obtained.

Music, as I have shown before, is something that the brain must translate first into music itself. Thus, totally-deaf people can be made aware of music. Years ago, before the New York Institute for the Deaf, I demonstrated the *Physiophone*, an instrument which I had invented. This instrument used an ordinary carbon microphone, instead of the sound box of a regulation phonograph, in series with batteries and the primary of a step-up transformer. Two handles connected to the transformer, were grasped by the deaf person who could thus *feel* through his hands, as electrical impulses, the musical vibrations as they originated in the phonograph record. Of course, the deaf man did not *hear* music. He only felt the rhythmical pulses, but in a short time it was possible for him to distinguish a waltz from a march, and pick up musical evaluations through the tingling electrical shocks in his hands.

It probably will be possible, in the future, to combine all the methods which I have here enumerated, into Super-music, the total effects of which it is difficult for us to fully appreciate from this vista.

• THE RADIO MONTH IN REVIEW •

The "radio news" paper for busy radio men. An illustrated digest of the important happenings of the month in every branch of the radio field.

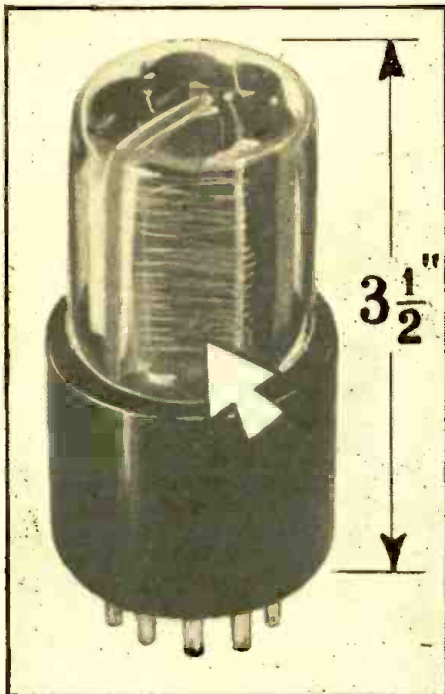

9-STAGE MULTIPLIER PHOTOTUBE!

Illustrated here is a new experimental 11-prong tube known in the RCA laboratories as the "electronically-focused multiplier phototube." Light impinging on the wire grid (arrow) is transformed into electricity and amplified by secondary emission through 9 stages, with an efficiency of 2.5 amperes/lumen (at 150 V. per stage). The overall voltage is 1,500 V. Immediate uses: in light-operated relays (garage-door openers, etc.); as a sound-track photocell; for talking-light beams.

ABROAD

ACCORDING to information received at *Radio-Craft* last month, British plane-spotting equipment now attains an accuracy of 5% at 200 miles, in locating and analyzing enemy planes as to their number, formation and type, as soon as they take to the

air! Batteries of what are virtually television receivers visualize the reflection, from the planes, of beams from transmitters which operate on the general principle of the altitude clearance indicator described in past issues of *Radio-Craft*. The principle involved was an accidental discovery of British television engineers, who in tracking-down ghost images observed on television screens during periods of non-modulation of television carriers, found that the specks, in geometrical formation, were due to reflections of the television carrier from airplanes.

Multitudes of Dutch citizens are reported to be regularly tuning-in B.B.C. broadcasts, and those of the Dutch government in London, despite the Damascus sword of a fine of 10,000 guilders and 2 to 8 years' imprisonment (or even death).

A cablegram to the *N. Y. Mirror*, from Stockholm, last month, quoted the newspaper *Helgens Nyheter* to the effect that Norwegian fishermen are holding 30 Germans as hostages for the safe return of a prominent Bergen physician threatened by the Nazis with execution for possessing a radio transmitter.

From Toronto comes the report that a dragnet by Canadian police netted a "phantom" radio station operated by the outlawed Communist Party of Canada to broadcast subversive propaganda. The 1,000-mile-radius transmitter was installed in an old automobile, power being derived from a generator driven by the car's engine.

DEFENSE

JUST in Case," we might title the broadcasts, last month, from the New York Telephone Building in downtown New York City, of the test of the Army's new "Air Defense Maneuvers." Some 10,000 volunteer civilian observers at 643 posts scattered over a 4-state area served as the "ears" of the

Army Defense Command in spotting "enemy" planes and telephoning their observations to Headquarters. This information resulted in the repulse of mock enemy attacks on the Eastern seaboard.

A radio-controlled bomb able to chalk-up a score of 9 hits out of a possible 10 is soon to be tested by U. S. Army engineers, INS reported last month.

Slow-speed Piper "Cub" airplanes were demonstrated to a U. S. National Guard unit to be superior to observation balloons or the high-speed planes previously used for reporting on target practice and Army maneuvers. A standard "walkie-talkie" Army portable, of the type illustrated in past issues of *Radio-Craft*, was put in the seat of the plane for the purpose of the tests and, without need for motor shielding or any special equipment, maintained contact with ground radio units.

In a recent broadcast over the N.B.C. network, Mr. Earl O. Shreve, a vice-President of the General Electric Co., disclosed that engineers are designing floating power plants and mobile substations to forestall any interruption of electric power anywhere in the U. S.

Demands of the U. S. Army and Navy are keeping a double shift of employees busy making carbon microphones, Universal Microphone Co., Ltd., reported last month.

Mr. T. R. Kennedy, writing in a recent issue of *The New York Times*, reports that a "television periscope is being tried out for submarines. A long cable connects the deeply submerged submarine with a floating 'eye' which scans the horizon."

TELEVISION

THE University of California is now offering its students an innovation in the curricula. A short, intensive course in Television Production and Acting has been inaugurated by the Extension Division of the U. of C. Instructor Catherine Sibley also directs and produces the Don Lee Television Station program "Television University" over W6XAO, Mt. Lee, Hollywood.

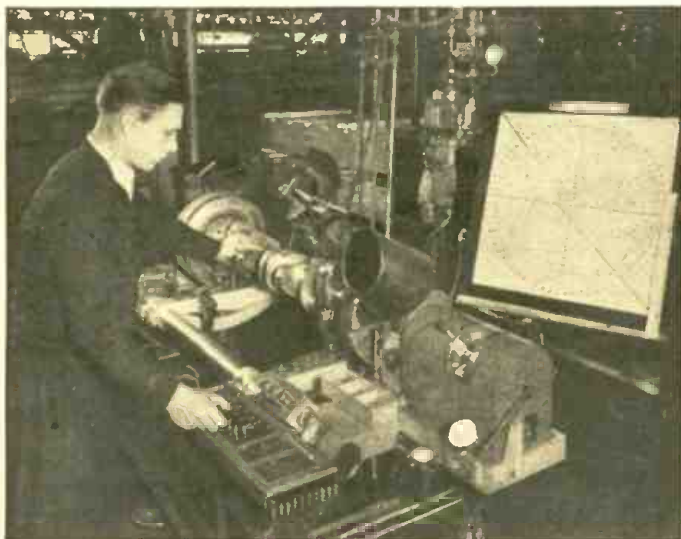

FACTORY ELECTRONICS

Balance is all-important in the assembly of a Chrysler Fluid Drive unit with the crankshaft and clutch mechanism. The operator shown above balances these parts carefully by glancing at the chart directly in front of him and can tell instantly just how much weight he must place on each part of the assembly. The degree and position of unbalance is shown by a pointer revolving on the face of a dial marked off in degrees of crankshaft rotation; a spark jumps between the periphery of the dial, and the end of the pointer being used as the indicator, when metal parts are correctly associated.



2-COLOR TELEVISION

Dr. Alexanderson and George H. Payne view the General Electric color-television setup demonstrated to the Federal Communications Commission last month. This system of color television is readily applicable to the exterior of any cathode-ray receiver, provided, of course, that the transmitter employs an equivalent arrangement. The 2-color system exhibits less flicker than does the 3-color system. The 24-inch disc shown here consists of 2 pieces of cellophane between which are Eastman orange-red and greenish-blue gelatin color filters to reproduce the color. It whirls at 1,800 r.p.m.

The new all-television building being built in Schenectady, N. Y., by the General Electric Co., to house station W2XB will be illuminated with water-cooled mercury lights that provide 1,000 foot-candles of illumination at any point on the stage. The 125-foot-high antenna is equipped with heating facilities that prevent the formation of ice in winter.

Theatre-screen-size television, using the English "Scophony" system of mechanical television, was demonstrated to Metropolitan audiences, including the F.C.C., last month. The Scophony Laboratories succeeded in perfecting the lower-fidelity English equipment to meet the 441-line high-fidelity standards of the American system, with an image that nearly filled a 10 x 14 ft. screen.

Members of the F.C.C. and of the National Television Systems Committee last month witnessed demonstrations of reception on a 20-inch cathode-ray receiving tube, of 625-line images, transmitted 15 frames per second, at station W2XWV, New York City, by Allen B. Du Mont Laboratories of Passaic, N. J.

Would you like to know what sort of fare is being offered to viewers in the Metropolitan area by N.B.C. station W2XBS? Here's the entire program of experimental transmissions during a single week:

Tuesday, Feb. 4

2:00 to 5:00 p.m., test pattern.
7:45 to 8:45 p.m., test pattern.
8:40 p.m., N.B.C. mobile television unit pick up of hockey from Madison Square Garden: N. Y. Americans vs. N. Y. Rangers.

Friday, Feb. 7

2:00 to 5:00 p.m., test pattern.
7:30 to 8:00 p.m., test pattern.
8:30 p.m., N.B.C. mobile television unit pick up of wrestling from Jamaica Arena.

Saturday, Feb. 8

2:00 to 5:00 p.m., test pattern.
7:10 to 8:10 p.m., test pattern.
8:10 p.m., N.B.C. mobile television unit pick up of basketball from Madison Square Garden: Long Island University vs. Duquesne, and C.C.N.Y. vs. Fordham.

ELECTRONICS

A REPERCUSSION of the war situation is an increase in the prices of radio tubes; one manufacturer last month reported an average increase of 5c per tube, "because of higher raw material costs."

In "The Challenge of the Electric Eye" (in a recent issue of *Magazine Digest*), Ritchie Calder concisely glosses over most of the more than 150 diverse devices which employ the photoelectric eye. Among these is the "Eupathoscope," which reproduces mechanically the way in which the human body responds to heat, to draughts, to humidity, and so-on. Conversely, it may be adapted so that it adjusts a room's atmosphere to suit an individual's degree of comfort.

Add new terminology: "Klystronics." This was the title selected by Westinghouse's Dr. E. V. Condon for his talk before the I.R.E., last month, on this new super-power generator (of microwave energy) described recently in *Radio-Craft*.

Members of the American Chemical Society learned of one of the newest tricks of the vacuum tube when engineers described



3-COLOR TELEVISION

Inside and outside views of the C.B.S. color television receiver. The 6 color-segments (shaped to reduce disc diameter) on the disc between cathode-ray tube and cabinet window are: red, green, blue, red, green, blue. The disc spins at 1,200 r.p.m., driven by a motor controlled from a phonic motor powered by the transmitted vertical synchronizing pulse suitably amplified. A pushbutton (arrow) helps synchronize the transmitter and receiver color-discs.

how an "electric ear" is used to control the operation of grinding mills. Briefly, the new technique utilizes a microphone, an amplifier, and mill-control equipment. Heretofore trained operators adjusted the feed to suit the degree of grinding (noise); the new setup accomplishes the same result automatically by electronic means.

Patent No. 2,228,064, issued to Wilhelm Runge, Hans O. Roosenstein and Werner Foggy (Berlin, Germany) describes how metallic "splinters" floating in air or certain liquids may function as a detector of ultra-shortwave signals. They align and thereby increase the opacity of the air or liquid to the passage of a lightbeam, modulated at audio frequency and focused on a photoelectric cell connected to an amplifier and loudspeaker, when 2 electrodes connected to antenna and ground are tuned to a radio station. Patent is assigned to Telefunken.

Last month Dean Joseph W. Barker, Columbia University School of Engineering, told engineers at the Winter convention of the A.I.E.E., that "we do not have to let the imagination run wild" to picture the possibility of a television-equipped reconnaissance plane over battlefields, according to a "Special to the N. Y. Times." The fact of the matter is that Dr. Lee de Forest is now developing just such an airplane along almost exactly the lines laid down by H. Gernsback over 15 years ago. (See illustration, right, from original article; the Cover Feature is a modernized version of this idea.)

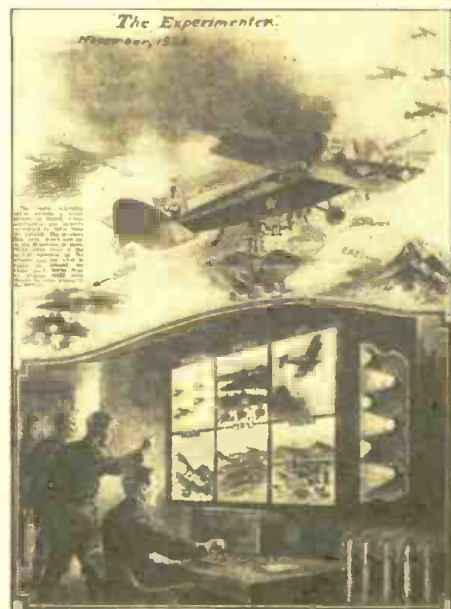

WAR TELEVISION ROBOT PLANE!

Shown here and (modernized) on the cover of *Radio-Craft* is a radio-controlled Robot Television Reconnaissance Plane. This plane, only an idea 16 years ago when it was devised by H. Gernsback and described in the Nov. 1924 issue of "The Experimenter," now is an almost accomplished fact! The idea: A robot plane, equipped with "eyes" (television cameras) that look in 6 directions at once, transmits its views to television receivers where observers note "enemy" activities and operate the Robot Television Reconnaissance Plane by remote control.

"FLIGHT COMMAND"

Robert Taylor, left, and Nat Pendleton anxiously watch to see whether the blind-landing radio beam equipment on which they have been working is going to be a colossal success—or a colossal failure with lives the forfeit. Eventually, their beam equipment lands an entire squadron of planes through a "pea-soup" fog, in Metro-Goldwyn-Mayer's latest picture. How they did it will thrill radio men.



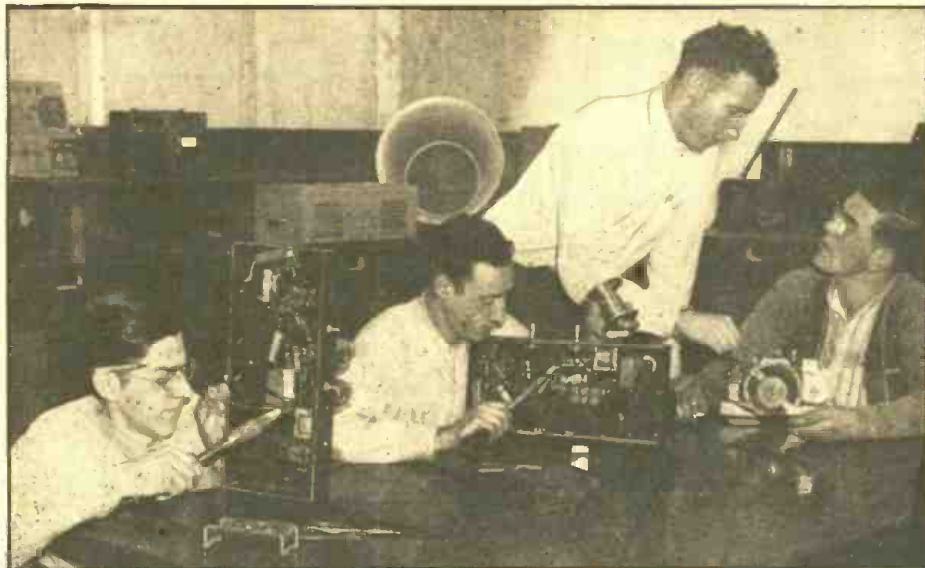

With the expansion of the radio industry impelled by the American Defense Program and general prosperity the National Youth Administration is redoubling its program to provide work-experienced youth to fill the substantially increased need for workers. How this program is being applied at radio "Work Experience Centers" in Illinois is described.

◀ At the N.Y.A. Radio Department, Dist. No. 3, Chicago, Illinois, Andrew Milauskas, Thomas Lopresti, Robert Wright and Coleman Walsh, left to right, are shown obtaining shop radio experience; the 2 youths at the left are working on a 12-watt P.A.-system amplifier, while the youth on the right is working on a midget A.C.-D.C. radio set. An instructor is standing.

N.Y.A. OFFERS RADIO TRAINING TO AMERICA'S YOUTH

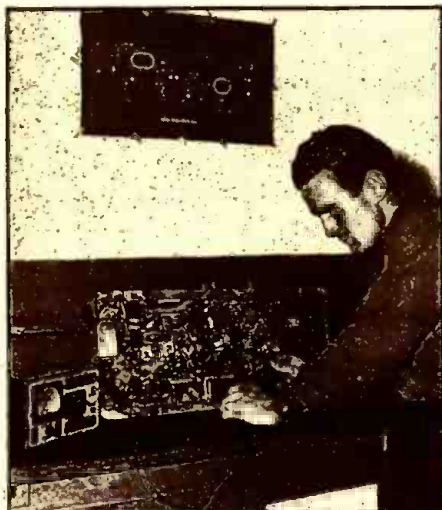

Henry Jankowski testing a radio set at the Work Experience Center on W. Huron St., in Chicago.

IN THE N.Y.A. program, which prepares hundreds of thousands of youth throughout the country for employment in all industries, Illinois plays a leading role. Here, under the direction of Administrator Mary Stuart Anderson, 33 centers are being opened and more than 7,000 young men and women are daily gaining valuable job experience—groundwork for jobs on the nation's assembly lines.

"Industry's increasing employment, particularly in lines engaged in national defense production, is decreasing the National Youth Administration rolls weekly," stated Administrator Anderson. "Many employers have come to look to the N.Y.A. for youths who have had some basic work experience, and who have stable shop habits."

To employers the N.Y.A. "Work Experience Centers" offer workers equipped with responsible attitudes, fundamental job techniques, and basic knowledge of radio and allied vocations. Youth who have been taught to be careful around machinery make safety-conscious workers. Youth who have had N.Y.A. radio shop experience have an

excellent foundation for any more skilled radio work. These youth have already been initiated into modern industry.

Actual radio repair and production experience under factory conditions is given to youth, not only in Illinois but throughout the nation. Outside agencies supply the materials or the radio sets to be repaired. The finished products are used by governmental and public agencies whose budget normally would not allow such purchases. Under present production schedules the radio shops are building and assembling radio receivers for use in the N.Y.A. Resident Centers. The N.Y.A. standards demand careful workmanship; and each job must pass a rigid inspection.

Explained Administrator Anderson: "In the operation of all Centers the N.Y.A. is striving to help both factors in the employment picture—those who want jobs and those who have jobs to offer. By providing youth with experience in the operation of industrial machinery and in handling tools the way is being made easier for these young people to find places in industry where they will be urgently needed."

The N.Y.A. through mechanical aptitude tests, endeavors to select for basic radio shop experience those youth who have the education and qualifications necessary for skilled workers. In all cases experience is offered on a step-by-step basis. Only as the youth masters one task is he given another. Although production is organized on assembly lines the youth are rotated through the various jobs to give them all-round experience.

In the factory-like shops, experience under skilled supervision is offered to both boys and girls on all phases of assembling and repairing radio receivers. Besides installing the coils, transformers, condensers, controls, and tuning mechanisms, youth with more ability are given opportunity to work as inspectors. They learn how to check each set for tone quality, sensitivity, selectivity and fidelity. By repairing radio sets the youth become acquainted with the ordinary difficulties and corrections. These youth are given a background knowledge of radio theory, elementary electricity, and magnetism.

Youth are given opportunity for vocational exploration inasmuch as the Centers offer other types of industrial work besides radio. Basic job experience is provided in sheet-metal work, welding, woodworking, foundry, forge, machine shop, drafting and designing. Aviation ground-mechanics' experience is included at a few of the Centers. For girls the work experience program offers power-sewing, sub-professional nursing, cooking and household work—and even radio! Twenty of the N.Y.A. centers in Illinois are for out-of-town youth and include living quarters as well as work shops. This youth power, otherwise wasted, is being converted by the N.Y.A. to run the turbines of America's industry. Unmarried young men and women, between the ages of 17 and 24 inclusive, who are in need of work or experience are eligible for N.Y.A. employment.



Anita Byrnes, here shown soldering a frequency meter at the W. Huron St. Center, proves that gender is no barrier to radio knowledge where the N.Y.A.'s aid in the defense program is concerned.

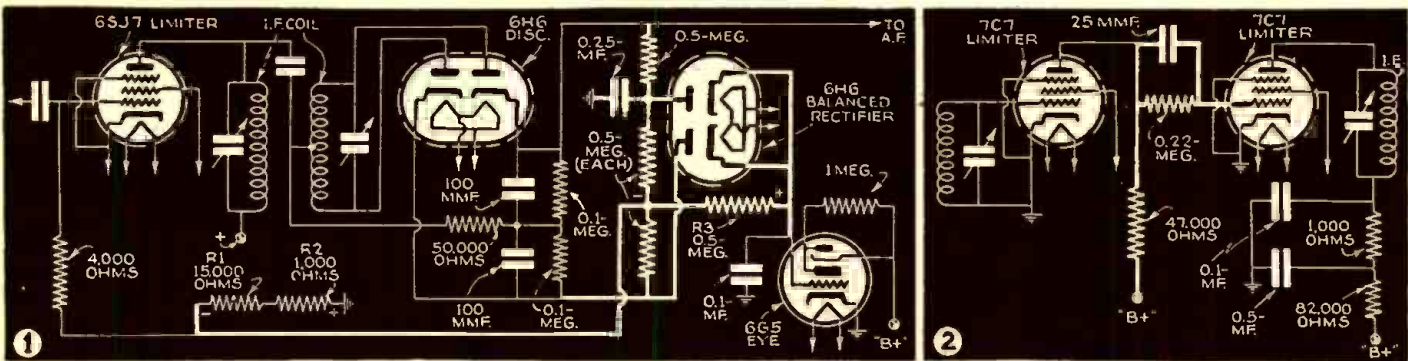

NEW CIRCUITS IN MODERN RADIO RECEIVERS



In this series, a well-known technician analyzes each new improvement in radio receiver circuits. A veritable compendium of modern radio engineering developments.

F. L. SPRAYBERRY

No. 43

(Fig. 1) NEW CIRCUIT USING "ELECTRIC EYE" AS F.M. TUNING INDICATOR

PILOT MODEL 12.—Through a novel and basically sound circuit the combination of maximum bias due to an incoming signal and zero potential difference between the discriminator cathodes, is made to operate an "electric eye" tube to indicate resonance.

Zero potential of difference between the discriminator cathodes is not sufficient in itself for operating the eye tube, while the negative bias generated at the limiter grid by the signal is much too broad to indicate resonance by itself. The two in combination, however, form an excellent resonance indicator as in Fig. 1.

The limiter grid circuit produces a bias from the signal which is negative with respect to ground across R1 and R2. This voltage is applied through R3 to the grid of the 6G5 indicator tube. Any D.C. potential difference between the discriminator cathodes of either polarity will form a D.C. voltage drop across R3, of the polarity indicated.

At resonance only, this voltage across R3 will be zero, a very well defined point, and the limiter bias will be wholly applied to the 6G5 grid. Either side of resonance this limiter bias voltage will be opposed by the drop across R3. The A.F. is filtered out of the circuit so that resonance will be indicated whether or not the carrier is modulated.

(Fig. 2) DIRECT-COUPLED LIMITER TUBES USED IN F.M. RECEIVER

ZENITH MODELS 10H551 AND 10H571.—Connection of the grid of the 2nd limiter tube to the plate of the first through a 0.22-meg. resistor with a shunt 25 mmf. condenser provides a permanent positive bias on the 2nd limiter grid and a coupling means suitable for a very great range of signal intensities.

The plate current of the 2nd limiter in Fig. 2 is maximum for the conditions of operation, the plate voltage is minimum and the grid current is near saturation. A positive pulse on the grid of any reasonable size cannot materially change these conditions. The plate current cannot substantially increase nor can the pulse act in the 2nd limiter plate circuit. A negative pulse on the other hand, can reduce the plate current whether it be only a fraction of a volt or over 100 volts. The effect on the plate circuit will be about the same for any grid signal in this range. The circuit is simpler and more effective than the usual one.

(Fig. 3) INDEPENDENT A.V.C. LINES

EMERSON MODELS ER-369 AND ER-370.—Separate A.V.C. feeders supplied from the same source enable independent control of the mixer and I.F. tubes. This arrangement as given in Fig. 3 shows how the 2 feeders are connected to the 2nd-detector.

This circuit very much reduces the possibility of interstage coupling through the A.V.C. line and permits easier localization of defects in one stage. Moreover, the 2 controlled circuits may be given different time constants, thus improving action by "diversity" of operation.

(Fig. 4) HUM REDUCED BY D.C.-OPERATED HEATER

RCA MODELS VHR-207 AND VHR-407.—The 12SK7 heater makes up the major part of the negative end of the bias voltage divider, carrying the D.C. of the high voltage power supply.

This type of filament supply (see Fig. 4) is used for this tube in an otherwise A.C. set because it is a microphone preamplifier where an extremely small hum component can become very important. The 12SK7 heater is shunted by a 2,000-ohm resistor to carry additional D.C. to the receiver circuit and to improve regulation of the filament voltage. Caution must of course be exercised in working with this circuit as any high-voltage short will burn out this filament.

(Fig. 5) CONTROL OF TONE MODIFIED BY DEGENERATION

GENERAL ELECTRIC MODEL J63.—The tone control is terminated at the 2nd audio cathode where the degenerative feed back is

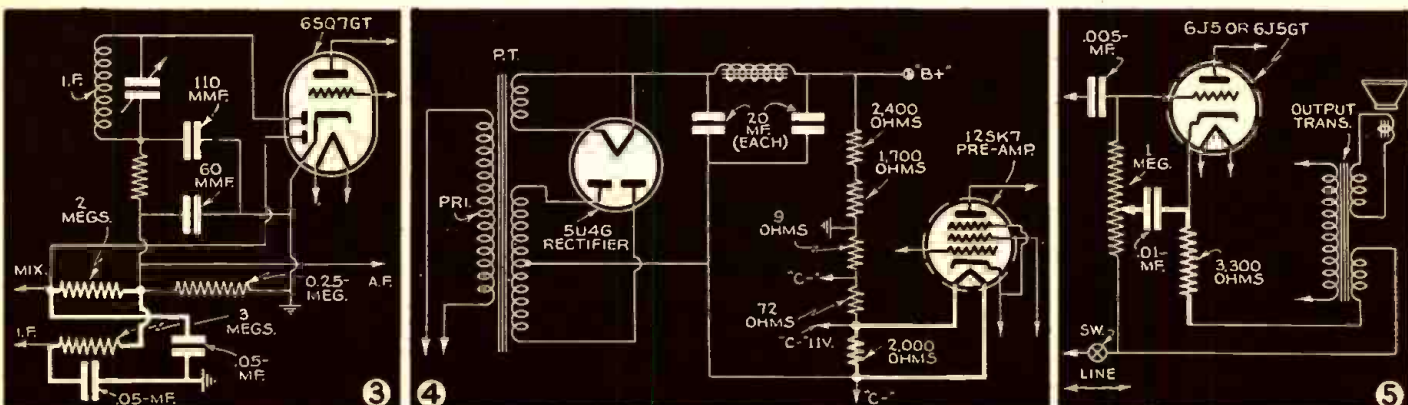

SERVICING

administered, so that the degenerative action may be frequency selective and so that the degree of frequency selection will depend on the setting of the tone control.

From Fig. 5, we may observe that when the tone control is set for maximum treble response, the degeneration is minimum be-

cause of the bypassing effect of the 0.01-mf. condenser. In this position, however, degeneration increases with low frequencies.

In the bass position of the tone control, though, the grid is effectively coupled to the cathode thus attenuating high frequencies at the input according to the usual tone

control operation. Although the degenerative feedback may be greatest at this setting there is relatively little frequency selection of the degenerative circuit as the grid-to-ground impedance is quite high. The coupling at this setting serves to improve the degenerative action at all frequencies.

OPERATING NOTES

Trouble in . . .

ATWATER KENT 86

Intermittent noise or repeated "crackling" sounds in this A.K. model, may be due to an arcing resistor (strip type) located near the rear apron of the chassis. Replace the bottom unit with a 10,000-ohm 1-watt resistor (in plate-circuit-return of 35 tube adjacent to resistor deck). Remove the defective strip resistor from the circuit entirely, else trouble may develop.

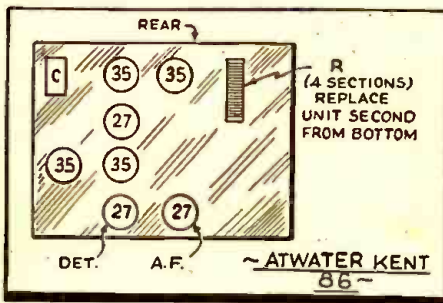

ATWATER KENT 82-D

If the complaint is: "set dead," look for an open filament-circuit resistor near the rear chassis apron. There may be a haywire condition from the wet electrolytic positive terminal to the type 36 screen-grid. Replace with a 100-ohm, 2-watt wire-wound unit.

Distortion—Return the type 36 detector grid-return to the 36's cathode, with a 50,000-ohm resistor and a 16-mf. shunt in series. This provides automatic instead of fixed-bias. Also check the plate load for open-circuit.

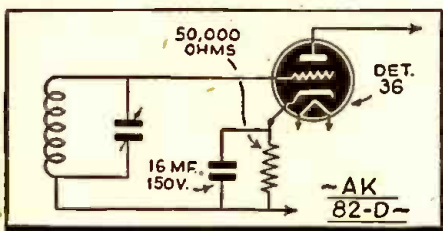

AUTOMATIC P40 PORTABLE

This set played on batteries but not on A.C. unless the Battery-A.C. switch was flipped first to Battery and then to A.C.

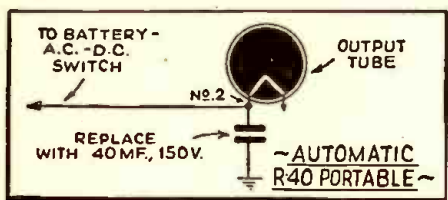

On A.C., without doing the above, the set would not play. An audio generator signal on the grid of 1T5-GT output tube did not appear at the plate terminal when checked with a signal tracer. The 1T5-GT voltages were normal except for no filament voltage. The reason appears in the diagram reproduced here. Make a continuity test with the 1T5-GT out of its socket, and if the

condenser shows a short, replace it with a small tubular 150-V., 40-mf. unit.

WILLARD MOODY,
New York, N. Y.

EMERSON U6B

We received an Emerson model U6B mid-gest with the complaint that it played from 15 to 30 minutes, then distorted and faded until the signal was barely audible.

The set was left for a check and we expected it was merely a gassy output tube. However changing the tube didn't remedy the trouble. Taking it for granted that the 43 was the offender, as the symptoms were identical with those of a gassy 43, the chassis was pulled out (in this model the chassis slides out of the bottom of the cabinet), the tube replaced and the chassis replaced in the cabinet. In 15 minutes or so the set resumed its fade and became distorted.

The tubes were completely checked, with special attention given to the 6H6 for shorts, and all tubes were replaced with a set known to be OK. The chassis was left on the bench and played several hours without fault (using its own tubes, too).

We returned it to the customer only to have it brought back with the same complaint! We pulled the chassis and the set played on the bench for 2 solid days perfectly but upon putting it back in the cabinet, it again went haywire.

Finally, I pulled it out of the cabinet once more and almost dropped it, as hot metal burnt my hands. The entire set was too hot to hold! The I.F.s, speaker and speaker frame, were as hot as a well-heated electric iron. We had noted a spot here and there under the chassis where some wax had dripped from the metal bypasses but as most midgests run rather hot normally, we paid little attention to it.

The conclusion was reached that the set was getting practically NO ventilation as the bottom was completely closed with a solid plate containing only a small number of vent-holes. The cabinet back is closed with heavy grille cloth covering the openings. Thus all the heat rises and is held in by the closed top. We removed the bottom plate entirely, took off the cloth covering the back of the set, giving the air a clear path for circulation. The set functioned perfectly and still does. Apparently the overheating of bypasses and filters lowered their efficiency and caused the whole trouble.

JAMES BAILIE,
Manhattan Radio Service,
New York, N. Y.

WILCOX-GAY MODEL A72 PORTABLE RECORDER

In some of the earlier model A-72 Portable Recordios, audio oscillation may be noticed with the volume control turned to near maximum position, when the 3-position switch is in the "CUT" position.

This oscillation manifests itself by a flickering of the indicator eye (6U5) and will appear in the playback of records which have been cut under this condition, as a "motorboating" sound of an intensity nearly equal to that of the recorded voice or music.

To correct this audio oscillation, disconnect the 6J7's 500,000-ohm screen-grid re-

sistor, R3, from the hum filter composed of C3 and R5, and connect it directly to "B+."

Figure A (below) shows the original circuit, and Figure B represents the circuit after the change has been made. It will be observed that this change has been incor-

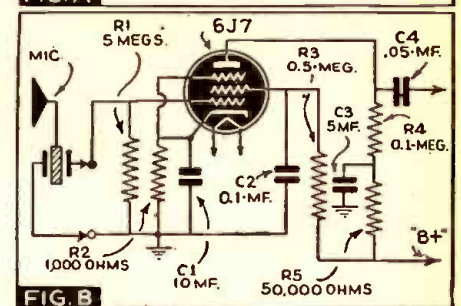
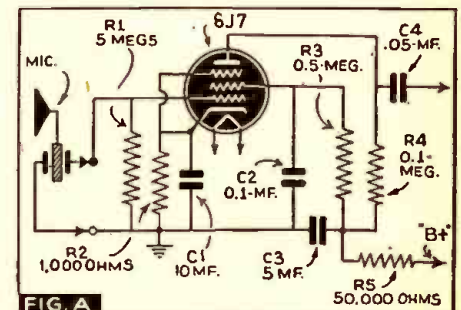

porated in the schematic diagram appearing in Service Bulletin No. 10.

WILCOX-GAY CORP.

RCA MODEL BT-42

If this set distorts badly at maximum volume, with volume control scratchy and erratic, I promptly suspect the 1H5G tube even though it may test good.

RCA MODEL 5BT

Some of these sets have a habit of cutting off, leaving the signal very faint and very distorted.

Upon checking the 30-type tubes (driver), the grid was found to have a high, positive voltage when set would "cut off". Replacing the coupling condenser had no effect.

It was finally decided that this audio stage was breaking into oscillation. The condition was cured by placing a 5,000-ohm resistor in series with the "B+" side of the primary of the input audio transformer.

JOHN LAWRENCE,
Kennett, Mo.

MOTOROLA MODEL 9-4, COM

Complaint: whistles over the standard broadcast band. Replace oscillator I.F. transformer, shown as assembly No. 47-H-37670A, page 1552, Gernsback Manual No. 7, with a Meissner 456 kc. iron-core assembly. Re-align the set and you will find this will completely eliminate all high-frequency whistles caused by receiver locations. I was unable to eliminate this condition in this district any other way.

EDWARD J. WELLS,
Wells Radio Service,
Penns Grove, N. J.

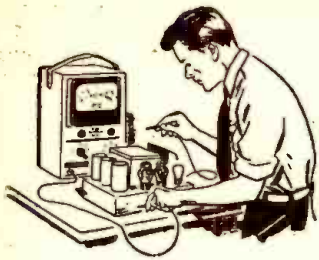

When You "Reset" or Repair Their "Big Sets"

THESE RADIOLA MODELS

SELL THEMSELVES

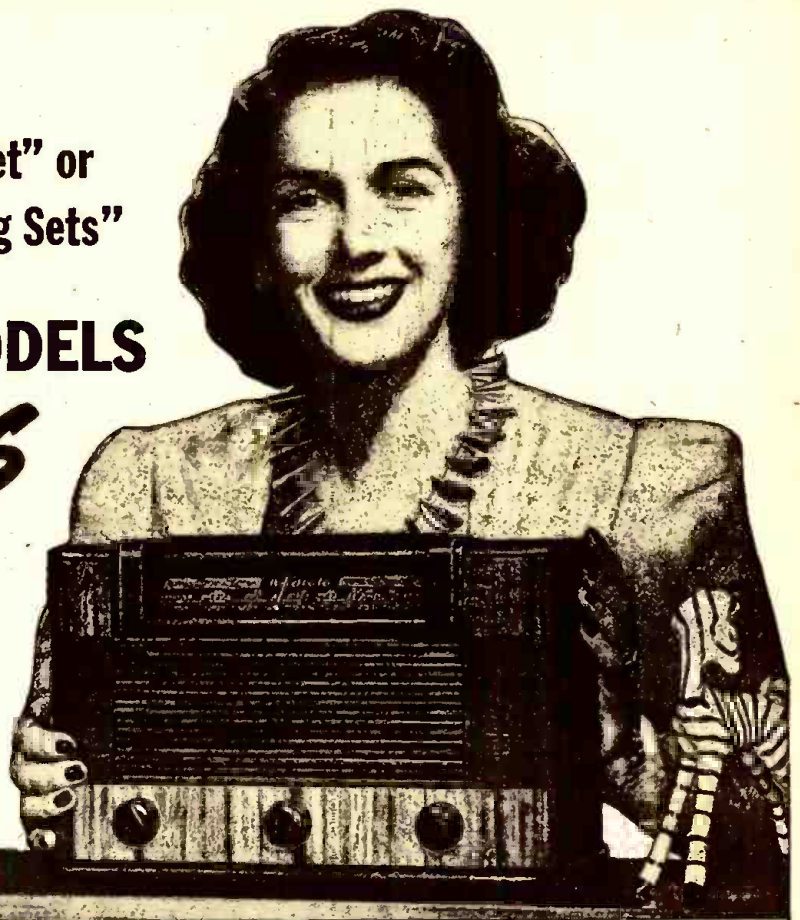

RADIOLA "Extra" Radios Mean Extra Sales... Extra Profits for SERVICEMEN

SUCCESSFUL SERVICEMEN are smart salesmen. That's why we designed a line of small, fine sets specifically for *servicemen* to sell.

Look at the RADIOLA 515 above. Suppose you leave it in a customer's home while their regular set is in your shop—or even just demonstrate it when you retune their radio push-buttons.

While *their* set is in your hands, your customers are discovering the added pleasure such an "extra" radio can bring. A radio they can carry easily from room to

room...a radio they can listen to at will. A radio with such top-notch features as *foreign reception*... R. F. stage for greater sensitivity... *six* RCA Preferred Type Tubes... continental-style wrap-around cabinet of costly woods... the RADIOLA 515!

Try it—see for yourself. Remember that your best service *customers* are your best RADIOLA *prospects*. And that RADIOLA alone is especially designed to be sold by servicemen... by *you*.



All RADIOLA Models Are Equipped Exclusively with RCA Preferred Type Tubes

"JINX" FALKENBURG, *America's Number 1 Model*, poses with *America's Number 1 profit-opportunity* for servicemen... the new Radiola Model 515. Both "Models" have plenty of eye-appeal!

SUPER-SELLERS, Every One!



RADIOLA Model 510... 110-volt AC-DC. Striking cabinet of molded plastic, with teardrop knobs and attractive clock-type dial. Highly efficient chassis embodies superheterodyne circuit, built-in tuned loop antenna, full AVC action. 5" Electrodynamic Speaker. 5 RCA Preferred Type Tubes.



RADIOLA Model P-5... A 3-way portable that's a real eye-opener. Operates from self-contained batteries, or 110-volt AC or DC line. Durable, washable simulated-leather covering. Built-in tuned loop. 5 RCA Preferred Type Tubes.

PLUS MANY OTHER FAST-SELLING MODELS

Radiola Preferred Type Radios

Made by RCA Manufacturing Co., Inc., Camden, N. J., U. S. A.
A Service of the Radio Corporation of America
In Canada, RCA Victor Company, Ltd., Montreal

FLUORESCENT LIGHTING

Latest Sideline for Servicemen

This is the last in a series of articles dealing with fluorescent lamps and their applications. The theory of these new light sources was covered in Part 1 (January issue), and the problem of radio interference in Part 2 (March issue).

PART III

INSTALLATION DESIGN

JOHN T. BAILEY

It is expected that this discussion of fluorescent lighting design of installations will be of value and will be welcomed by Servicemen who have had occasion to service interference trouble in connection with these lamps. The public will expect a Serviceman who can fix a fluorescent fixture to figure, at least approximately, how many of what watts-rating lamps are required to light a room properly.

A thorough discussion of this subject would take much more space than can be devoted to it here so in order to give the Serviceman a background of essentials the subject will be tabulated in "hand-book" style that will permit him to make intelligent replies to his customers' questions.

WATTS REQUIRED

The following, Table I, will give the amounts of power required per square foot of floor area to produce the recommended amounts and quality of general illumination for the types of areas listed. The number of square feet per fixture is then determined after a survey of the local conditions affecting the spacing is made, bearing in mind that the maximum allowable spacing is determined by the mounting height. This value is listed in Table I under the type of fixture illustrated.

As an example, let us assume that it is desired to light a factory area 50 feet by 50 feet with a 12-foot ceiling, in which "rough work" is performed.

Table I lists 20 foot-candles of illumination as the recommendation for this type of work. The width of the room is about 4 times the ceiling height so in the columns corresponding to these conditions it will be found that 0.9 of a watt per square foot of floor area will be required. The ceiling being 12 feet high fixes the mounting height of the reflector at about 10 feet above the floor. The spacing between units then should be 10 feet in each direction since this spacing is less than the maximum of 1.1 times the mounting height and it is a convenient spacing for this size room. The area per fixture then is 10 x 10 or 100 sq. ft. and at 0.9-watt per square foot, the watts power per fixture should be .9 times 100 or 90 watts. Therefore, a fixture equipped for two 40-watt lamps would be satisfactory, the total power per fixture including the auxiliary loss being about 96 watts.

HOW MANY LAMPS? WHAT SIZE?

Many questions asked will have to do with the number and power (watts) of fluorescent lamps required to replace an existing incandescent lamp installation. This immediately gives the Serviceman something to figure from. If the reason for making the change is to provide more light without overloading an already loaded circuit, reference to Table II will guide the selection of lamps.

This table indicates that without exceeding the present lamp watts-rating, the generated light can be more than doubled

by the combination of power (watts) and numbers of lamps shown. It is desirable to operate fluorescent lamps in pairs as explained in Part I of this series, so in most instances, four 30-watt lamps would be preferred to three 40-watt lamps although the latter combination will give an increase of 142% in light rather than 123% for the former. Table III lists the light output of the various fluorescent lamps so that the light output of any combination of lamps can be determined.



It should be noted that Table II merely

indicates the increase in amount of light generated by fluorescent lamps of equal watts rating. It may be used to arrive at the increase in illumination at the work level only when the efficiency and distribution pattern of light from the new fixtures are the same as the replaced fixtures.

LIGHT-QUALITY VS. WATTS

The distribution of light is similar in many ways to the distribution of sound in P.A. work. The ideal lighting system calls for the right quantity and the right quality

TABLE I
Design Data for General Illumination

The values in this table are based on white lamps. If daylight lamps are used increase the watts power 17%; if soft-white, increase 40%.	Semi-indirect			Semi-direct			Direct		
									
Max. spacing between units	1.5 x ceiling ht.			1.3 x mounting ht.			1.1 x mounting ht.		
Watts incl. auxiliaries	Watts/D' of area			Watts/D' of area			Watts/D' of area		
Room proportions	W=H	W=2H	W=4H	W=H	W=2H	W=4H	W=H	W=2H	W=4H
OFFICES									
SCHOOLS									
5-15 10 Ft.-c. { Conference Cafeterias Reception Corridors Auditoriums Washrooms	1.0	.8	.6	1.0	.7	.5	.8	.5	.4
15-30 20 Ft.-c. { Classrooms Libraries Laboratories Casual desk-work General clerical Filing	2.0	1.6	1.3						
30-75 50 Ft.-c. { Critical desk-work Drafting Stenographic Accounting Bookkeeping Proofreading	5.0	3.9	3.2						
75-150 100 Ft.-c. { Drafting Sight saving Business machines	10.0	7.8	6.4						
STORES									
5-15 10 Ft.-c. { Stockrooms Washrooms				1.0	.7	.6	.8	.5	.4
15-30 20 Ft.-c. { Neighborhood type	2.0	1.6	1.3	2.0	1.4	1.1			
30-75 50 Ft.-c. { General sales	5.0	3.9	3.2	5.0	3.5	2.8			
INDUSTRIAL									
5-15 10 Ft.-c. { Toolrooms Warehouse Lockers Loading Shipping Inactive areas Boiler rooms Garages							.8	.5	.4
15-30 20 Ft.-c. { Rough work Foundry Woodworking Pressing Shearing							1.6	1.0	.9
30-75 50 Ft.-c. { General assembly Painting Typesetting Sewing Casual inspection							4.0	2.5	2.1
75-150 100 Ft.-c. { Machining Critical inspection Color work Fine assembly							8.1	5.1	4.2

of light. The quantity is determined by the power (in watts); and, the quality, by the lighting fixture.

As in P.A. work, where the quantity and quality are determined by power and equipment respectively, it is possible to reduce the amount of light if the quality of light is improved. This is a well-known fact to sound engineers who have compared a smaller watts rating of high-fidelity sound to a larger power of just "P.A." It is also appreciated that there are many instances where high-fidelity sound is not required. The same holds for lighting—for instance, the superior quality of indirect lighting is not generally required nor found practicable for industrial plants.

Although not described in detail here, the analogy between the proper application of light and sound will become evident to the Serviceman. Table I has been formulated to guide the selection of proper lighting equipment for most types of work requiring light but it should be remembered that there are many instances where special, individual attention must be given to obtain satisfactory results. The solution to such problems usually will be found after a little thought is given and possibly a few trial systems will be required to get the best results.

The slender, tubular, form of the fluorescent lamp lends itself to continuous rows of lighting equipment mounted, usually, over assembly lines, inspection tables, workbenches and other "in-line" operations where high levels of cool light are especially desirable. The radioman's service bench is one of the best locations for him to install a few lamps to experience the benefits of fluorescent lighting.

HEAT VS. COLD

A word of caution would not be amiss at this point regarding the use of fluorescent lamps in cold weather. As discussed in Part

I, the light output falls off as the temperature is lowered. Mazda F lamps are recommended only for normal indoor use. Their application outdoors or where low temperatures are involved must be made at the customer's risk.

When operated on approved auxiliaries they will give, in general, satisfactory performance at temperatures down to as low as 50° F. If the line voltage is in the upper half of the rated range of the auxiliary, if the lamp is enclosed or protected from drafts and if a thermal switch is used, the performance will ordinarily be acceptable down to 32° F. At lower temperatures than 32° F. trouble may be encountered in starting, occasional lamps may burn unsteadily and light output and lamp life may be reduced dependent on the degree to which the above precautions are observed. Secondary sources of heat will improve performance and may be found worthwhile where extreme cold is encountered.

The design and application information given in this article is not intended to provide Servicemen with an extensive background in the lighting profession since to do so would require more space than could be devoted to it here. However, the data given should permit a Serviceman to determine in a general way how to figure a fluorescent lighting installation.

It is suggested that, as a check on his design, the Serviceman consult the local utility office or a lighting engineer before proceeding with the expense of relighting his or his customer's stores. As with any business, including service work, maximum satisfaction of the customer is assured only after the seller has acquired competency in design based on broad experience in his business.

This article has been prepared from data supplied by courtesy of Westinghouse Lamp Division.

TABLE II

PRESENT INCANDESCENT SYSTEM				NEW FLUORESCENT SYSTEM			
Lamp Watts	Number per Fixture	Generated Light (Lumens)	Lamp Watts	Number per Fixture	Approx. Fixture Watts*	Generated Light (Lumens)**	Ratio of Generated light (fluorescent to incandescent)
40	1	470	15	2	39	1,170	2.50 to 1
50	1	660	20	2	49	1,800	2.73 to 1
60	1	830	15	3	59	1,755	2.12 to 1
75	1	1,100	15	4	78	2,340	2.12 to 1
			20	3	74	2,700	2.45 to 1
			30	2	75	2,900	2.63 to 1
100	1	1,600	15	5	98	2,925	1.83 to 1
			20	4	98	3,600	2.25 to 1
			30	3	115	4,350	2.72 to 1
			40	2	98	4,200	2.62 to 1
150	1	2,600	20	6	147	3,400	2.08 to 1
			30	4	150	6,800	2.23 to 1
			40	3	151	6,300	2.42 to 1
			100	1	135	4,400	1.69 to 1
200	1	3,700	30	5	190	7,250	1.96 to 1
			40	4	196	8,400	2.27 to 1
300	1	5,750	30	8	300	11,600	2.02 to 1
			40	6	294	12,600	2.19 to 1
500	1	10,000	40	10	490	21,000	2.10 to 1
			100	4	470	17,600	1.76 to 1

*Includes auxiliary watts ratings.
**For white lamps.

TABLE III Approx. initial light output in lumens	Lamp Watts	15	20	30	40	100
	Color:	White	585	900	1,450	2,100
	Daylight	495	760	1,250	1,800	—
	Soft White	435	640	1,050	1,500	—
	Pink	300	440	750	—	—
	Green	900	1,300	2,250	—	—
	Blue	45	60	120	—	—
	Gold	375	540	930	—	—

WEATHERPROOFED ANTENNAS

Radio station WHK's new self-supporting square radio antenna, 223 ft. high, is said to be the tallest of its type in the world. Its purpose is to "shunt" WHK's programs away from station KLRA. The hollow porcelain "feet" in which the 4 legs of the tower

rest are filled with oil, which is maintained at a uniform temperature by thermostatic control to prevent the formation of ice or moisture films on the insulator regardless of the weather conditions, according to technical advisor E. L. Gove.

More Than 25 Proved Sales Promotion Services Help You Sell



WHEN you stock Sylvania Radio Tubes, you get the most comprehensive and effective merchandising service that ever helped a dealer to bigger profits.

Look over the partial list below. Many are free. Others are available at satisfying savings. All help you sell.

Write Hygrade Sylvania Corp., Dept. RC41, Emporium, Pa., for samples of these selling aids and full information about the Sylvania way to bigger profits.

Sylvania Helps... That Help You Sell

- Window Display Material (the TWA Display pictured above, dummy tube cartons, timely window streamers, etc.)
- Counter displays
- Electric Clock signs
- Electric Window signs
- Outdoor metal signs
- Window cards
- Personalized postal cards
- Imprinted match books
- Imprinted tube stickers
- Business cards
- Door Knob Hangers
- Newspaper mats
- Store stationery
- Bill heads
- Service hints booklets
- Technical manual
- Tube base charts
- Price cards
- Sylvania News
- Characteristics Sheets
- Interchangeable tube charts
- Tube complement books
- Floor model cabinet
- Large and small service carrying kits
- Customer card index files
- Service Garments
- 3-in-1 business forms
- Job record cards (with customer receipt)

SYLVANIA
SET-TESTED RADIO TUBES

Also makers of Hygrade Lamp Bulbs, Hygrade Fluorescent Lamps and Miralume Fluorescent Light Fixtures

305

Radio Service Data Sheet

ZENITH "CHAIR-SIDE" RADIO MODELS 105531—105549—105566 (Chassis Model 10A1)

10-tube Superhet.; A.C. Operation; 3-Bands; 540-1,600 kc. (556-187.5 meters), 1,500-5,200 kc. (200-57.7 meters), 5,700-18,300 kc. (52.6-16.4 meters); Automatic Volume Control; 6-Station Pushbutton Electric Tuning; "Radiorgan Tone Color Blender"; 10-inch Electrodynamic Loudspeaker; Push-pull Output; "Wave Magnet" Built-in Antenna; Tuned Wavetrap; Power Output 14 watts. (See Data Sheet No. 304 for the schematic diagram.)



Zenith Model 105549, Chair-side radio

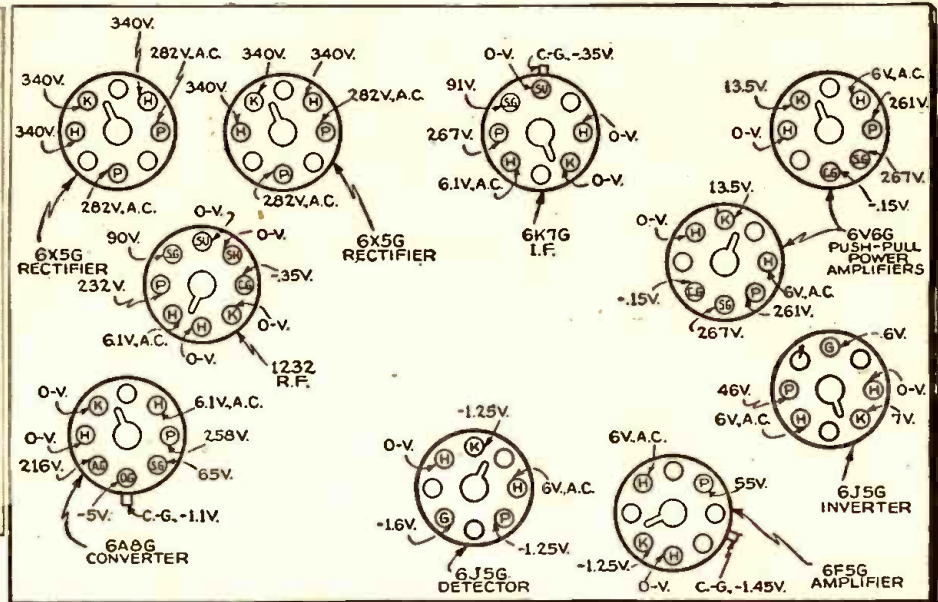

Underside view of chassis showing all tube sockets and normal operating voltages.

All voltages indicated in the upper right-hand illustration are measured with a 20,000 ohms/volt meter from chassis to socket contact indicated.

All voltages are positive D.C. unless marked otherwise.

Volume control full on.
Line voltage 117 V.
Power consumption—10A1—95 watts.
Power consumption—10A2—120 watts.
Power output—14 watts.

Stage Gains:
Ant. to R.F. grid—3.7X at 1,000 kc.
R.F. grid to converter grid—9.7X at 1,000 kc.

Converter grid to I.F. grid—63X at 455 kc.
Overall audio—1.250X at 1 watt, 400 cycles.
Technicians may wish to know of the following features of this particular receiver which are not disclosed by the diagram:

The input circuit is preceded by a stage of R.F. amplification which increases the sensitivity and otherwise improves the receiver over sets which have the antenna feeding directly into the converter stage. An oversize chassis affords exceptional space between components. A so-called "steering wheel" waveband control operates "arrow flash" band indicators. The power transformer is of special design to provide constant voltage under varying loads.

The built-in-loop antenna is electrostatically shielded. Its primary has a high impedance. In most cases, good short-wave reception is possible via a built-in shortwave aerial. The "radiorgan tone color blender" with 6 organ-type stops is said to provide 64 individual tonal combinations. One of the pushbuttons may be resonated to a television-sound channel. The pushbutton tuning, which is electric and not mechanical, may be adjusted from the front of the cabinet.

The built-in wavetrap eliminates commercial code interference. Designed to operate on A.C. lines of 110 to 125 volts.

View of the chassis showing all major components, positions of tubes, and the locations of the various alignment trimmers.

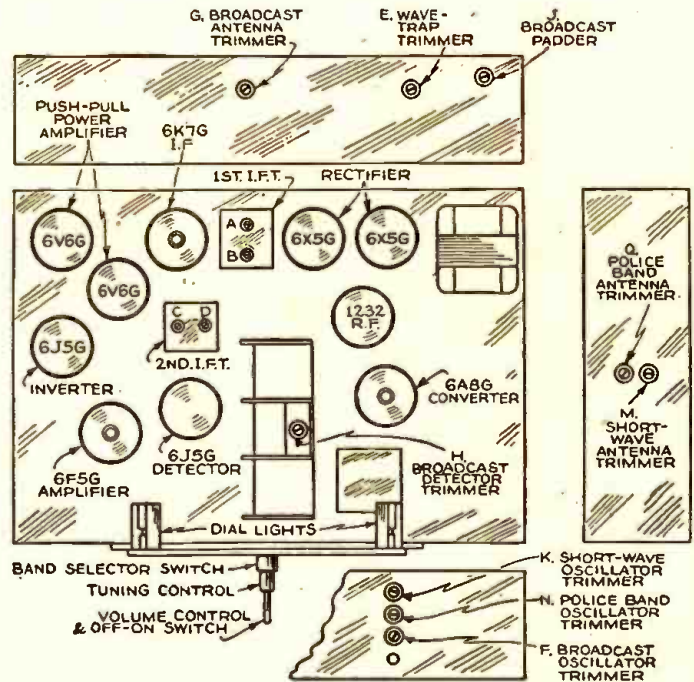

ALIGNMENT PROCEDURE

Operation	Conn. Test Osc. to	Dummy Ant.	Input Sig. Freq.	Set Dial at	Band	Trimmers	Purpose
1	Converter Grid	0.5-mf.	455 kc.	B.C.	600 kc.	A B C D	Align I.F.
2	Ant.-Gnd. with 10-ohm shunt	"	455 kc.	B.C.	600 kc.	E	Adjust for Minimum
3	"	400 ohms	18 mc.	S.W.	18 mc.	K	Set to Scale
4	"	"	16 mc.	S.W.	16 mc.	M	Align ant.
5	"	"	4.5 mc.	POL.	4.5 mc.	Q	Set to Scale
6	"	"	4.5 mc.	POL.	4.5 mc.	F	Align ant.
7	"	0.5-mf.	1,500 kc.	B.C.	1,500 kc.	F	Set to Scale
8	"	"	1,400 kc.	B.C.	1,400 kc.	G-H	Align R.F. Det.
9	"	"	600 kc.	B.C.	600 kc.	J	Rock Gang and Adj. Padder
10	"	"	1,500 kc.	B.C.	1,500 kc.	F-G-H	Rpt. 7 & 8

SIGNAL TRACING AMPLIFIER

An Effective Radio Servicing Tool

The Signal Tracing Amplifier here described has been devised to aid radio Servicemen in quickly spotting faults in the remaining 10% of service problems the average radio repair man fails to clear quickly if only because they are not total "failures." The 10% of "unusual" cases of intermittent operation, internal noise, instability, low sensitivity, "dead spots", and an assortment of other cases, must respond to proper stage analysis with the Signal Tracing Amplifier.

L. M. DEZETTEL



The completed Signal Tracing Amplifier.

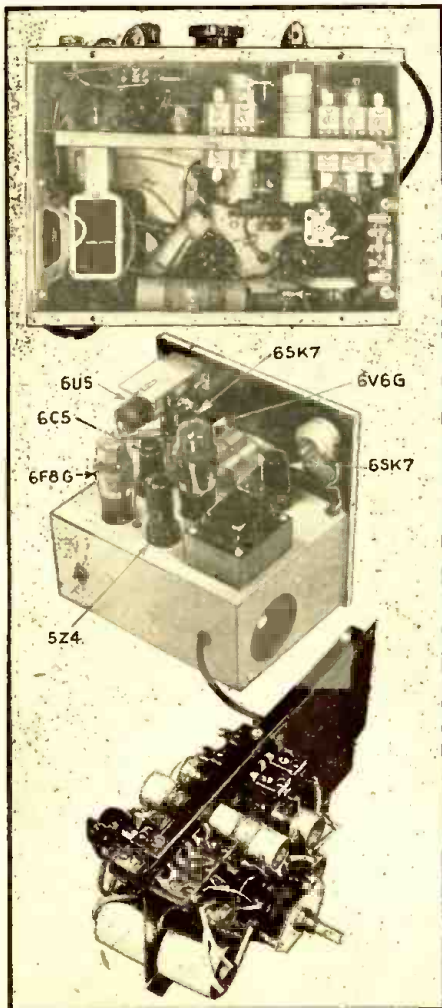

Underside and rear views (top and center, respectively) of the Signal Tracing Amplifier; and, a close-up of the coil and trimmer arrangement.

DURING the past year, "Signal Tracing", as a method of locating circuit failure, especially intermittent cases, has grown in popularity. This popularity is not due to the fact that most units now on the market have built-in voltmeters, measure power output or indicate audio signal, but only because (for the first time) an instrument has been made available which will allow operating frequency, relative R.F. gain, and oscillator performance to be checked. Any competent Serviceman does not require a "robot" with a half-dozen "eyes" to locate the receiver fault. He can usually place the failure in the audio, I.F., R.F., or oscillator stages within a few moments' inspection.

THE 10% OR "PROBLEM" SERVICE JOBS

Eliminating tube failure, 90% of the service cases encountered are total "failures". The set is "dead," distorted or weak; and the causes lie in shorted or open condensers, open resistors, chokes, field coils, burned-out power transformers, worn insulation and loose connections. The remaining 10% may be grouped into a class of unusual cases, most of which have been serviced at a loss since they represent intermittent operation, internal noise, instability, low sensitivity (with voltages and other parts in perfect condition), "dead spots" and a varied assortment of cases which defy description.

It is with these cases that we are primarily interested. If we have an instrument capable of checking approximate stage gain, identifying frequency of operation and locating poor bypassing, we have a tool which is invaluable to the Serviceman.

The instrument described here is such a tool. The principle is not new, but the application is.

For the first time, an amplifier is presented which has approximately constant gain throughout the broadcast and I.F. bands allowing stage gain to be checked stage-by-stage. In addition, the range has been extended to 17 mc., covering the most important shortwave channels. Oscillator performance may be checked at the higher frequencies where the greatest trouble is encountered; and frequency may be measured with sufficient accuracy to determine whether or not the oscillator is operating on the proper beat; and of more importance, the determination of proper tracking may be made. Intermittent cases due to R.F., oscillator, or I.F. failure may be located quickly and low-gain stages may be located easily.

CIRCUIT

Essentially, this unit consists of an untuned input stage with a capacitive attenuator allowing signal input to be attenuated by factors of 1, 10, 100, and 1,000. This untuned stage is followed by 2 tuned stages working into the input of an infinite-impedance detector.

The audio component of the R.F. signal is amplified and made available for use with speaker, headphones, meter, or oscilloscope.

The D.C. rise, due to rectification, is amplified and applied to a 6E5 electron-ray indicator ("eye") tube. Operated thus, the electron-ray tube indicates the presence of a signal whether modulated or not.

To facilitate the use of the instrument, the dial reads directly in frequency. Two

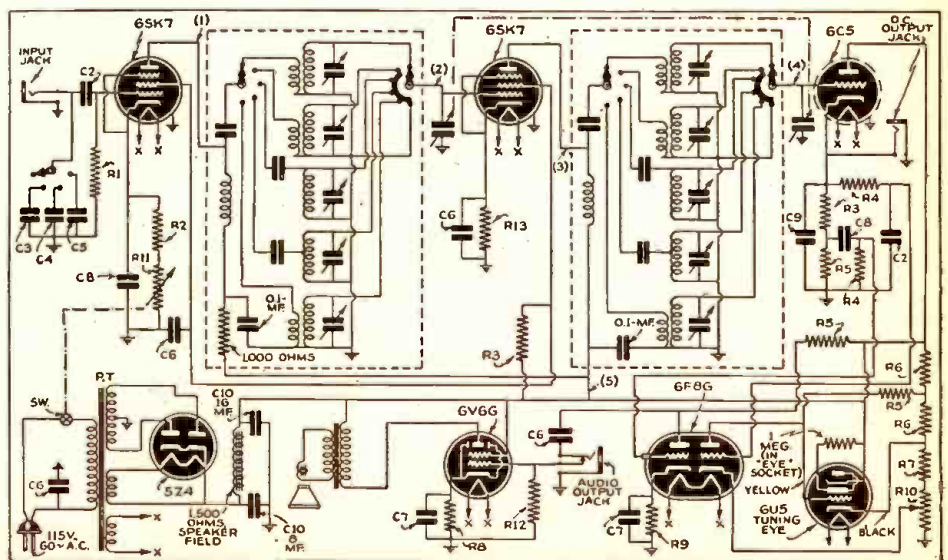

Schematic diagram of the Signal Tracing Amplifier.

scales are provided, one for the low-frequency, broadcast and high-frequency bands, the other for the I.F. and police bands. The proper scale and multiplying factor being determined by the scale on the band switch. The scale reads frequency directly and since only 2 scales are used, they are open, and minor divisions of frequency allowing faster and more accurate operation may be made.

The basis of this instrument consists of a kit, essential parts containing a ready-drilled panel, cabinet and chassis, a 2-gang, 442 mmf. tuning condenser, and a completely-wired and tested R.F. assembly consisting of 10 coils and rotary coil switch. The coils are matched to extreme accuracy and, if directions are followed, no trouble will be had in calibrating the unit after it has been assembled.

ASSEMBLY AND WIRING

The best method of assembly is as follows:

Wire all heater, power supply and D.C. circuits, taking special care to run all leads close to the left of the chassis (looking into underside of chassis with the front towards you) so that they will fall into the notch when the R.F. assembly is placed into position. The detector cathode filter, and the audio coupling network, may be mounted into place; the voltage divider and plate resistor assembly however should be temporarily left unfastened. It may be mounted after the R.F. assembly is in place.

Carefully check all wiring since a great many connections will be inaccessible after the R.F. unit is in place. All connections should be complete at this point except the 1st R.F. plate lead (numbered 1 in the schematic diagram), which should be cut 1 1/2 ins. long. The lead from the 2nd 6SK7 grid to the switch (numbered 2), should be cut 4 ins. long. The lead from the 2nd 6SK7 plate should be cut about 8 ins. long for ease in threading through a grommet in the stage shield connecting to the R.F. choke on the rear of the switch assembly (numbered 3) after which it may be cut short to prevent excessive lead length. The lead (numbered 4) from the 6C5 grid to the coil switch should be cut 2 1/2 ins long; and the lead (numbered 5) from the R.F. assembly to the proper "B+" point on the voltage divider. All of the above leads should be in place for ease in soldering to the coil switch after assembly.

To place the R.F. assembly in the chassis, move the voltage divider as noted above, start the switch shaft through the proper hole, thread the braided ground strap through the hole near the gang condenser (where it will be soldered first to the chassis) above the chassis, and to the center shield and wiper of the gang condenser, and gently push the unit into place, taking care that no leads are caught between the lip and the chassis. It is a tight squeeze between the 6C5 socket, but it will make it if care is taken.

Rearrange all misplaced wires and fasten the panel in place using the nuts on the switches and input jack to bind it in place. A gap should appear on both sides and on the bottom between the folded lips on the panel and the chassis to allow room for the case when in place. Three self-tapping screws fasten the R.F. assembly to the chassis, after which it should be "bended" to the chassis with the lengths of braid soldered to the shield. The plate and grid wires should be attached and dressed-down to the chassis, and well away from each other, to prevent unwanted feedback. A washer should be placed on the shaft and the knob and pointer lined-up with the gauge lines on the dial. It will be noted that

A TUBE TESTER.. A BATTERY TESTER

All for Only
\$29⁹⁵
 Terms: \$4.00 cash and 8 monthly payments of \$3.53
FREE
 TUBE SETTING SERVICE FOR ONE YEAR

IN producing Model 589 there has been no compromise in the circuit design or materials. The same manufacturing methods, careful inspection and accurate calibration are incorporated in this instrument as in all other SUPREME testers. It will pay you to investigate and see this tester before you buy. Its price is the lowest at which a GOOD tube tester can be built.

MODEL 589 TUBE AND BATTERY tester has a completely modernized circuit. The tube test sockets are not wired directly to the circuit, but, instead, pass through the patented SUPREME Double Floating Filament Return Selector system which automatically re-connects all tube elements to any possible tube base arrangement. Due to the fact that any or all elements of each socket can be rotated to any desired position, only one socket of each type is necessary. Tests every type of tube from 1.4 volts to full-line voltage at its correct anode potential under proper load. Tests separate sections in multi-purpose tubes. Checks all leakages, shorts, open elements and filament continuity with a neon lamp. A circuit insert is provided for checking noise, leakage, loose and bad connections. The battery testing circuit of the Model 589 provides the proper load at which each battery is to operate, plainly marked on the panel, for all 1.5, 4.5, 6.0, 45 and 90 volt portable radio types. The condition of the battery is indicated on an English reading scale. This is the fastest and easiest tester to operate.



Just "follow the arrows"—you can't go wrong—Roller type tube chart with brass geared mechanism lists tubes in logical numerical order. Each tester carries a one year free tube setting service. SUPREME engineering and construction PLUS the best materials the market affords, make the 589 your biggest dollar value. You will be proud to own this instrument.

MODEL 599 TUBE AND SET TESTER is very similar in appearance to the Model 589, and includes all the features and advantages of this instrument. In addition, it provides the following ranges:

- 0.2 TO 1500 D.C. VOLTS—5 carefully selected ranges—0/6/15/150/600/1500 volts. 1000 ohms per volt STANDARD sensitivity.
- 0.2 TO 600 A.C. VOLTS—4 A.C. ranges—0/6/15/150/600 volts. Rectifier guaranteed with instrument and fully protected from overload damages.
- 0.2 M.A. TO 600 M.A.—3 direct current ranges 0/6/60/600 allow measurement of screen, plate, "B" supply and D.C. filament loads.
- 0.2 TO 600 OUTPUT VOLTS—0/6/15/150/600—ideal for alignment. No button to hold down—no external condenser necessary.
- 0.1 OHM TO 20 MEGOHMS—4 ranges 0/200/20,000 ohms, 0/2/20 megohms. A low range at high current with 3.5 ohms center scale.

ELECTROSTATIC—ELECTROLYTIC LEAKAGE TEST—Sensitive calibrated 20 megohm range provides excellent leakage test of paper and electrolytic condensers. Just as the 589 is your best value in a tube and battery tester, the 599 is your best value in a combination tube tester, battery tester and set tester. Remember, you have all the features of the 589 PLUS a complete AC, DC volt; ohm; megohm, milliammeter, at a cost of only 47c per range. Dealer Net Cash Price **\$39.50**



Terms: \$4.50 cash; 9 payments of \$4.33.

SUPREME
 SUPREME INSTRUMENTS CORP. GREENWOOD, MISSISSIPPI, U.S.A.
 New Catalog Just Off Press. Write for your copy Today!

Illustrated above is the Model 589 in a counter type metal case. This model is available with option of 7" or 9" illuminated meters. Has two neon lamps for sensitive or super-sensitive tests. Write for prices and information.

Metal cabinets as illustrated for the Model 589 at left and 599 above are identical—can be used either in a horizontal position or vertical position by merely reversing the instrument panel. Write for prices and information.

110 VOLTS AC ANYWHERE
 With KATOLIGHT. Furnish standard 60-cycle AC for operating sound truck equipment, AC radios, transmitters, flood lights, motors, moving picture projectors, etc.

 A complete line of light and power plants ranging up to 10,000 watts capacity. Also 6, 12 and 32 volt battery charging plants. Diesel plants, rotary converters, and frequency changers.
LIST PRICES \$50.00 AND UP
 Jobbers and Dealers Write for Latest Catalog
Kato Engineering Co.
 10 ELM ST., MANKATO, MINN.

COMPLETE Flexible SHAFT WORKSHOP at only **\$14⁹⁵**

27" FLEXIBLE SHAFT.
USES 200 ACCESSORIES
PENCIL-SIZE HANDPIECE
PENCIL-SIZE HANDPIECE For "Finger-Tip" Control
 You, too, will win real pleasure and profit by using a Foredom Flexible Shaft Workshop. Performs countless tasks quickly, efficiently, effortlessly in home or shop. Thousands use them on wood, metal, glass, plastics, etc. Pencil-size handpiece affords sensitive "finger-tip" control, easy accessibility. Assures unobstructed view. You can grind, polish, mill, engrave, sharpen, slot, saw, carve, clean, sand, etc. Ideal for glass etching, gem-setting, and finishing dies, molds, castings, etc. Only \$14.95 for complete Portable Workshop, including 50-piece accessory set!
10-DAY FREE TRIAL!
 Money back, if not satisfied. Enclose \$1.00 with C.O.D. order, or send \$14.95 check, or M.O. FOREDOM—fine tools since 1922.
FREE! NEW CATALOG
 Write for It! Illustrates complete line Flexible Shaft Tools and Accessories.
Foredom Electric Co.
 Dept. 204
 27 Park Placc, New York, N. Y.

*it's an old
RCP custom!*

BIG VALUE . . . LOW PRICE
test equipment

FOUR WORDS TELL YOU why this RCP line of test instruments shot to stardom almost overnight. It was good to begin with, inside and out. It has the professional look that counts for so much. And back of impressive appearance, ability. Rare is the RCP Test Instrument that's designed for one job alone. When you replace with RCP, you're economizing on space as well as cost. Big value . . . low price—a double reason why you should be using dependable RCP Test Equipment. Look how much a little money buys—

RCP TUBE TESTER

Model 309SC

\$16.95



TESTS ALL TUBES—new miniature, regular receiving, all ballast, and tubes with filament voltages up to full line. Indicates noisy tubes that otherwise test GOOD. Hot interelement short and leakage test between all individual elements. Spare socket provision for future tubes with new base arrangements.

Individual tests of each section of full-wave rectifiers, duo diodes and all multi-purpose tubes. High sensitivity neon indication. Accurate calibration. Continuously variable adjustment for all line voltages from 105 to 135 volts by means of a 25 watt power rheostat. Simple and speedy to operate.

Model 309SP (Combination Portable and Counter Case) **\$18.95**

RCP SIGNAL GENERATOR

Model 702

\$22.95

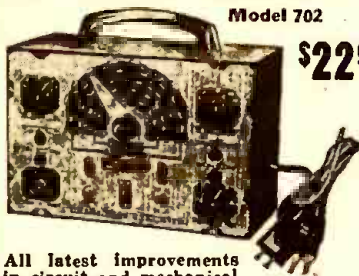

All latest improvements in circuit and mechanical design. Extremely wide all-wave coverage continuously variable from 95 Kilocycles to 100 Megacycles. Output modulated at will. 30% modulation at 400 cycles, sine wave from self-contained independent 400 cycle circuit. Attenuation in approximate microvolt calibration by means of five step ladder attenuator. A.C. operated.

Send for new 1941 catalog (No. 124) describing the complete line of dependable RCP Test Equipment. Write today.

RCP
dependable
TEST
instruments

RADIO CITY
PRODUCTS CO., INC.

88 PARK PLACE · NEW YORK, N.Y.

the pointer is non-symmetrical. The end identified by the small drill hole near the knob should be placed on the "A" scale and the knob fastened in place so that the pointer line falls just below the horizontal dividing line between the A and B scales when the condenser is rotated to full capacity. This is the correct position for proper calibration.

CHECKING

The unit is now ready for a preliminary test. The band switch should be set to the broadcast position which corresponds to the identification A x 10; an antenna should then be coupled to the receiver. If all wiring has been done correctly, local broadcast stations should be heard with the multiplier switch in the 1X position and the gain dial at 1. Remember that this control works in the opposite direction from the usual volume control.

A signal generator is required for the next step. Each set of coils is accurately matched, but slight differences in wiring and input capacities require that the trimmers be adjusted for the high-frequency end of each band. Using the signal generator, the following adjustments should be made: Band No. 1, Long Wave "A" set dial and test oscillator to 140 kc., and adjust trimmers 1 and 2 for maximum indication of the "eye". Full input gain and the attenuator set at 1X should be used for preliminary indication, all being reduced as the peak is reached, just as in aligning any radio chassis.

The "eye" gives a very sharp indication and it is well to use phones during preliminary calibration. Band No. 2, "B" is aligned at 400 kc.; Band No. 3, A x 10 at 1,400 kc.; Band No. 4, B x 10 at 4,000 kc.; and, Band No. 5, A x 100 at 14,000 kc., using the electronic "eye" to adjust for maximum sensitivity. The proper adjustment is at the point where the "eye" just starts to close with the gain control (P11) in the full "on" position and the input test prod shorted to chassis (no signal).

THE DOUBLE-CHECK

One point of importance should be observed. Circuit oscillation will result with the bottom of the chassis unshielded, and therefore it will be necessary to use a piece of metal pressed tightly to the bottom and touching both lips of the chassis and coil assembly to shield the unit during calibration, moving it so that the trimmers for each band are just accessible for adjustment.

Due to the amplified action on the electron-ray indicator the range over which it operates is extremely small. Less than a 10% variation in input will show "full open" to "full closed." Therefore, in use, the maximum sensitivity should be used: R.F. gain "full on" and the attenuator in the "1X" position. After the signal has been located, the gain may be adjusted for proper "eye" operation.

Since the audio component must be filtered from the detector output, a slight lag will be noted in the eye operation due to the resistance-capacity filter of 1 meg. resistor and 0.05-mf. condenser. In tuning, the condenser should be rotated slowly to avoid the possibility of missing the signal.

HOW TO USE

The use of the instrument as an indicator is simple. A signal from a test oscillator or transmitting station is tuned-in and by applying the test prod in rotation from antenna, R.F. grid, detector grid, etc., we are able to note a low-gain stage or a "dead" stage. Since the "eye" is extremely sensitive, noisy stages will be shown up easily.

The unit may be employed as an "isochrometer," indicating exact zero-beat and zero-phase difference by feeding both the known and unknown frequencies into the input. Beats between harmonically related frequencies will also be indicated.

The test prod may be placed in contact with any R.F. circuit without changing the circuit resonance or loading to an appreciable extent. The A.C. output is available for headphones or oscilloscope use, as is the D.C. output from the detector. One word of caution, however. The use of an oscilloscope with a Frequency-Modulated oscillator should not be attempted, since the resulting curve will have the resonance characteristics of the signal tracer as well as the receiver and the result is useless in interpreting the actual receiver characteristics.

Since it is necessary to keep the input capacity low to prevent changing the characteristics of the circuit under test, a small 2 mmf. condenser is built into the end of the test lead. Since the coaxial cable used presents a capacity as does the input capacity of the tube plus the wiring capacity, we have a condition which limits the sensitivity of the unit by a factor of 25:1 (the input capacity before the 2 mmf. condenser is 50 mmf.). Due to this fact, when the unit is to be used to check for a defective bypass condenser, for field strength measurements or frequency measurement from weak stations, an improvement may be made in sensitivity by making a new lead using unshielded wires and an Amphenol MC1F connector, and placing a 50 mmf. condenser in series when used for direct antenna connection.

LIST OF PARTS

CONDENSERS

- Two paper, 0.05-mf. 400-V., C2;
- One mica, 200 mmf. and 1—250 mmf. in parallel for 450 mmf., C3;
- One paper, 0.005-mf. 400-V., C4;
- One paper, 0.05-mf. 400-V., C5;
- Five paper, 0.1-mf. 400-V., C6;
- Two electrolytic, 10 mf. 25-V., C7;
- One paper, .01-mf. 400-V., C8;
- One mica, 500 mmf., C9;
- One dual electrolytic, 8-16 mf. 450-V., C10.

RESISTORS

- One 0.25-meg., ½-W., R1;
- One 0.15-meg., ½-W., R2;
- Two 50,000 ohms, ½-W., R3;
- Two 1 meg., ½-W., R4;
- Three 0.1-meg., ½-W., R5;
- Two 10,000 ohms, ½-W., R6;
- One 7,500 ohms, 1-W., R7;
- One 250 ohms, 1-W., R8;
- One 1,000 ohms, ½-W., R9;
- One 5,000 ohms potentiometer, R10;
- One 15,000 ohms, potentiometer, with switch (special taper, Carron B1097), R11;
- One 0.5-meg., ½-W., R12;
- One 500 ohms, ½-W., R13.

TUBES

- Two 6SK7s;
- One 6C5;
- One 6F8G;
- One 5Z4;
- One 6U5;
- One 6V6G.

ADDITIONAL PARTS

- One essential parts kit, consisting of 5-band 2-stage R.F. coil assembly, 2-gang condenser C1, dial and hardware, punched chassis and panel, metal case, switch and R.F. cable. Carron CCH;
- One 3-in. dynamic speaker with matching transformer and 1,500-ohm field;
- One single-circuit jack;



Learn RADIO SERVICE WORK with these 2 BIG Ghirardi BOOKS

MODERN Radio SERVICING

Learn How with this! Here's the world's most highly praised course in practical radio service work—all for you in this one handsome 1300-page home-study book. First, a big 420-page section explains all types of servicing test instruments—how they work, how constructed, how to build, how to use them. Then, 800 more pages give you a thorough, step-by-step procedure course in trouble-shooting, testing, aligning and repairing all makes of radio sets and other electronic devices by latest scientific "factory methods." Learn radio servicing this quick, easy, economical way. Learn WHAT to do and HOW to do it. Get your copy today. \$4



RADIO Trouble Shooter's HANDBOOK

Save Time with this! Here's real help for servicemen—518 big manual-size pages of valuable, time-saving, factory-checked servicing data right at your finger tips to help you do every servicing job quickly and accurately. It's 52 BIG SECTIONS contain 275 large pages of time-saving "Case Histories" on over 3,300 receivers... Alignment data for over 15,000 superhets... Servicing and installation data for all Auto Radios... Trouble-Shooting Charts... Tube, Resistor and Condenser Charts... EVERYTHING! Speed up your service work with all the vital servicing data NOW in this one big book. \$3



MAIL COUPON TODAY!

Radio & Tech. Publ. Co., Dept. RC-41
45 Astor Pl., New York

Employed and payment for: MODERN RADIO SERVICING RADIO TROUBLE SHOOTER'S HANDBOOK

Check here for FREE circulars. BOTH books at \$6.50 Money-Saving Combination Price

NAME
ADDRESS
CITY STATE

MONEY-BACK IF NOT SATISFIED!

300 WAYS TO MAKE MONEY

Cash In!

68 PAGES

MAIL ORDER PLANS TESTED MONEY MAKERS BUSINESS SECRETS SUCCESS SCHEMES

25 CENTS

Marvel Book of the Year! 40,000 WORDS in TEXT!

In "CASH IN" you get ALL the real money-makers—dozens of profitable tested mail order plans, confidential business secrets, dozens of practical tested formulas, successful tested schemes—actual experiences of men who have started on a shoestring—with less than \$10 capital.

SOLD ON A MONEY-BACK GUARANTEE

Buyers of This Book Tell Us—

"Biggest value I've yet to see. Book is worth at least a dollar." S. Buda, B'klyn, N. Y.

"Your book is as good if not better than others selling at \$1.00." George Brunet, Montreal, Can.

"CASH IN is the best value I have yet to see in the mail order field." Lawrence Fox, Brooklyn, N. Y.

"CASH IN" contains only tested ideas covering every type of full- or spare-time enterprise—it's a "masterpiece" in business ventures.

BOOK CONTAINS NO ADVERTISING
10c a copy postpaid. Send U.S. stamps or coin.

NATIONAL PLANS INSTITUTE
246-R Fifth Ave., N.Y.C.

FILMGRAPH
VOICE and MUSIC RECORDINGS

Lengthy or continuous recordings now possible with newly patented "FILMGRAPH." Over 13 hours of indexed voice, radio, code, telephone recording on a single 500 ft. reel of film costing \$3.00 and up. No other expense. INSTANTANEOUS and PERMANENT play-back. Can easily be synchronized with Motion pictures. Bulletins free.

MILES REPRODUCER CO., INC., Dept. RCB
812 Broadway New York City

- One 2-circuit jack;
- Six octal sockets;
- One Amphenol MEA-10 visual tuning "eye" assembly;
- One Amphenol PC-1-M male chassis connector;
- One Stancor P-6010 power transformer;
- One power line cord;
- Three small bar knobs;
- Miscellaneous hardware, hookup wire and braided ground strap wire.

This article has been prepared from material supplied by courtesy of Allied Radio Corp. in cooperation with Carron Mfg. Co.

RADIO IN THE NORTHWEST

RADIO wavelengths are weaving a network of medical security over the wilds of the Northwest Territories. Aided by 2-way radio sets, 9 resident doctors employed by the Territorial Council supply the medical needs of about 10,000 Indians, Eskimos, trappers, traders, miners and missionaries scattered throughout 1,300,000 square miles of icefields, rock and lake country and barren islands.

Their practice extends from the northern boundaries of the 3 Prairie Provinces and part of British Columbia to the far reaches of the Arctic circle and from the western end of Labrador to the Yukon Territory.

The outpost Physicians previously served only northerners within reach of dog teams or boats and canoes. These restrictions usually held them within a 100 miles radius of their stations except for airplane mercy flights. Now northern ether waves crackle day and night with medical messages from resident doctors at Aklavik, Fort Smith, Norman, Pangnirtung, Resolution, Chesterfield, Port Radium, Yellowknife and Simpson. Trading posts, missions and Royal Canadian Mounted Police stations throughout the silent tundraland pick up and send the mercy messages.

The Hudson's Bay Company, oldest trading firm in the British Empire, has installed 2-way radio sets in 78 of its 215 northern posts. Each post has at least one employee able to send and receive radio messages and plans are being made to install 25 additional sets next summer.

When aid is required, one of the Government doctors is called to the radio station. The emergency is described and the physician tells the operator what medicine or treatment is necessary.

All far-north settlements are stocked with medical supplies. Emergencies ranging from measles to childbirth have been met by radio prescription!

Should weather unfavorable to radio blot out urgent messages in one direction, signals are stretched to far-off sets, sometimes reaching a doctor 1,000 miles off.

ROY CARMICHAEL,
Montreal, Que., Canada

ORCHIDS

An orchid, Walter, to WOR, for their swell job of dramatizing the construction of a bomber. Listeners received practically first-hand information on the process, from A to Z, via the following remote pick-ups: designing and planning, and the processing of raw materials, at the Carnegie Illinois Steel Co. and the Revere Copper and Brass Co.; the manufacture of machine tools, Cincinnati Milling Machine Co., engine construction, Pratt and Whitney (Hartford, Conn.); plane assembly, Lockheed aircraft plant (Burbank, Calif.); finally, a bomber went aloft over Long Island, N. Y.

RADIO made EASY

with Ghirardi's BIG 1-Volume Radio Training Course

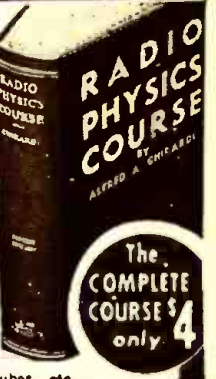

Fit yourself, at home in spare time, for a good-paying Radio Job. Yes, you can do it—with Ghirardi to help you, as he has helped thousands of others who got their basic training in Radio from his world-famous Radio Physics Course. It's easy this way, because Ghirardi has "hooked" you for making it all vividly clear and easy to understand. You need no "background" to prepare you for this intensive course of technical training—not even a knowledge of math! Ghirardi will "lead you through" from elementary electricity right through Radio, Sound, Television, Cathode-Ray Tubes, etc., etc. It's all explained simply and completely—in this one big 972-page book that costs you only \$4.

The COMPLETE COURSE \$4 only 4

USED BY U. S. ARMY and NAVY

Because of its excellence, Radio Physics Course has the rare honor of being used as the training text in the radio courses conducted by the U. S. Army and Navy. In fact, it is recommended and praised everywhere as "tops," and is used by more radio schools and students than any other radio text in the world! Here's what you learn!

- 36 Volumes in 1—972 pp.—508 illus.**
1. Radio Broadcasting System.
 2. Sound, Speech, Music.
 3. Electron Theory; Elec. Current.
 4. Elec. Units; Ohm's Law; Resistance.
 5. Elec. Circuits.
 6. Batteries.
 7. Magnetism.
 8. Electromagnetism.
 9. Electromagnetic Induction.
 10. Capacitance; Condensers.
 11. A. C. Circuits.
 12. Filters.
 13. Measuring Instruments.
 14. Radio Waves.
 15. Broadcasting.
 16. Receiving.
 17. Vacuum Tube Principles.
 18. Vacuum Tube Characteristics.
 19. Vacuum Tube Construction.
 20. Vacuum Tube Detector and Amplifier Action.
 21. Radio Frequency Amplification.
 22. "Superhets."
 23. R.F. Amplifiers; Tuning Coils.
 24. Audio Amplifiers.
 25. Speakers.
 26. Battery Operated Receivers.
 27. Power-Supply Units.
 28. Elec. Receivers.
 29. Automobile and Aircraft Radio.
 30. Phono Pickups; Sound Systems.
 31. Short-Wave.
 32. Photoelectric Cells; Cathode-Ray Tubes.
 33. Television.
 34. Antennas and Grounds.
 35. Testing; Servicing.
 36. Sound Motion Pictures.
- 656 Self-Review Questional Send for this great book NOW!

Test it—5 DAY TRIAL—MAIL NOW!

RADIO & TECHNICAL PUBLISHING CO.,
45 Astor Place, New York, Dept. RC-41.

Here is my \$4 (\$4.50 foreign) Send my copy of Ghirardi's RADIO PHYSICS COURSE postpaid.

NAME
ADDRESS
CITY STATE

Send me free illustrated descriptive literature.

MONEY BACK IF NOT SATISFIED!

Big in VALUE

Readrite RANGER MODEL 432-A

The Outstanding Tube Tester Value . . . Checks all type tubes including Local's, Bantam Jr., 1.4 volt Miniatures, Gaseous Rectifier, Ballast, High Voltage Series, etc. Filament Voltages from 1.1 to 110 volts. Direct Reading GOOD-BAD Meter Scale. Professional-appearing case with accessory compartment large enough for carrying Model 739 AC-DC Pocket Volt-Ohm-Milliammeter, thereby giving the serviceman complete testing facilities for calls in the field. . . .

Model 432-A with compartment, Dealer Net Price . . . \$18.85.

Model 432-A in case less compartment \$17.85.

Model 739, Dealer Net Price . . . \$9.90.

WRITE FOR CATALOG—Section 416 College Drive
READRITE METER WORKS, Bluffton, Ohio

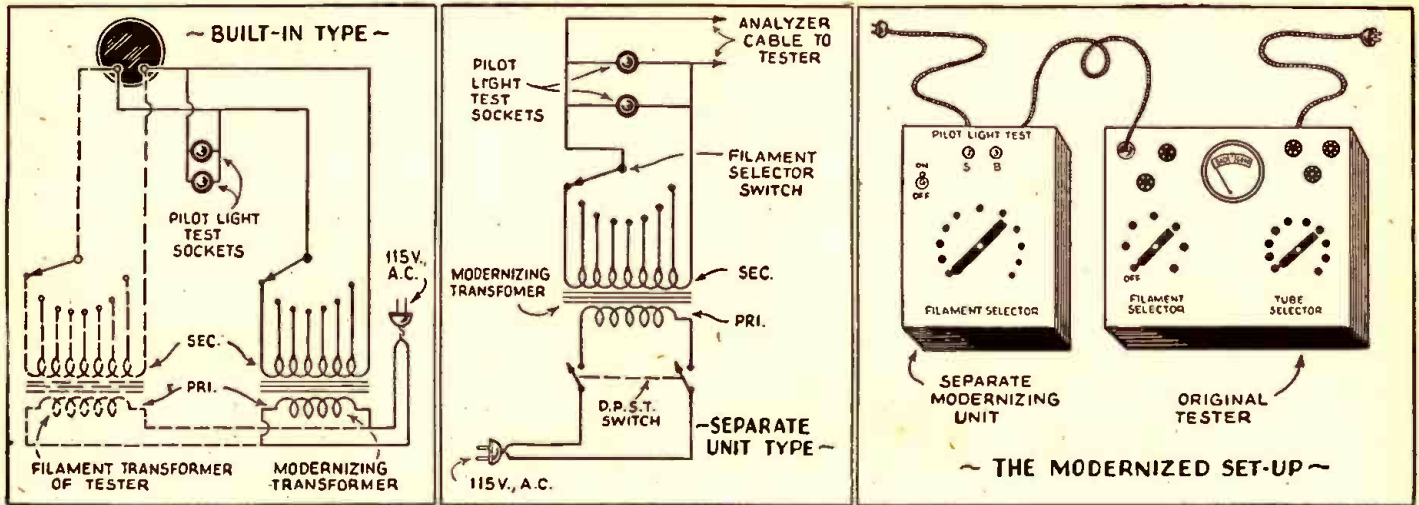

If there's no room to build-in the new transformer and switch (Fig. 1, left), in your test unit's case, try using a separate unit (Figs. 2 and 3, center and right).

MODERNIZE YOUR TESTER

To Check High-Voltage-Heater Tubes

A new filament transformer, a new filament selector switch, and presto!, you are ready with your old tester to test even 117-volt-filament tubes. Read this article and learn how easy it is to do a face-lifting job on otherwise outmoded tube testers.

D. J. FOARD, E.E.

IT WASN'T so very long ago that I purchased a tube and set tester that would accommodate only 4- and 5-prong tubes, this because those were the only tubes in use at the time. But shortly thereafter it became necessary for me to trade this instrument in for instruments that would accommodate 6- and 7-prong tubes. Then along came metal tubes and I had to purchase testers with provision for octal-base tubes. Not long ago some technician invented loctal bases and the modernity of my test equipment was once again subjected to considerable question. Then came "bantams" and other types of midget tubes and I began to wonder if it wouldn't be wiser to rent test equipment!

To cap the climax, so to speak, tube manufacturers introduced the new high-voltage-heater tubes. Though they are unquestionably a forward stride in improving the efficiency and life of A.C.-D.C. receivers, they do present still another problem for those of us who must service the receivers in which they are used.

At the present time, there are a great many fine tube testers and combination testers which are modern, or which have been rendered modern through the use of adapters, except that there is no provision for the high-voltage-heater tubes. Though we do not encounter these tubes as yet with alarming frequency, practically all of the new A.C.-D.C. sets employ them and it will not be long until they will be coming in every day. As many of us have had to change test equipment all too frequently in the last few years, most of us dislike to again have to purchase new equipment. At the present time, modernization of the equipment of most shops requires only provision for the high-voltage-heater tubes. Fortunately, most Servicemen can do such modernization themselves, easily and inexpensively.

BUILT-IN MODERNIZATION

Most radio transformer manufacturers now manufacture tube tester filament transformers, with secondaries of from 1 to 117 volts. These transformers can be purchased for \$2 or \$3 from any large radio supply house. Most tube testers, as well as most combination testers, have sufficient spare room in which to mount the modernizing transformer and, as most of these transformers are quite small, installing them in the tester should present no great difficulty. See Fig. 1.

A new filament voltage selector switch is, of course, necessary and one must use a switch with a position for each of the secondary taps of the modernizing transformer. These switches, together with a suitable filament selector switch plate, can be obtained from any large radio supply house.

PROCEDURE

As soon as the modernizing transformer has been mounted in the tester, the primary is wired in parallel with the primary of the original transformer, and the filament supply leads of the original transformer are cut-off at the transformer. The old filament selector switch is then removed from the tester and the new switch installed in its place. The secondary leads of the modernizing transformer are then wired, in proper order, to the various lugs of the new filament selector switch.

The lead which ran from the original transformer's secondary directly to the tube socket is, of course, wired onto the modernizing transformer. Too, the lead from the tube sockets to the arm of the filament selector switch is wired onto the arm of the new filament selector switch. This will complete the modernization and the tester will now deliver all of the higher filament voltages,

as well as the lower voltages, through the new transformer and filament selector switch.

INDEPENDENT MODERNIZATION

If it is not possible, or desired, to install a built-in modernization, as described above, a separate unit can very easily be built which will operate well on any tester having the filaments of the various tube sockets wired in parallel. The separate unit can be housed in almost any type of case and has a separate power cord and an "on-off" switch. See Fig. 2.

The modernizing transformer is installed in the case, the "on-off" switch and filament selector switch then mounted on the panel. The "on-off" switch is then wired in the power cord input to the primary of the modernizing transformer. One wire from the secondary of the modernizing transformer, and a lead from the arm of the filament selector switch are then wired to a 2-wire analyzer cable. The cable should terminate in a 4-prong analyzer plug with the 2 wires soldered to the 2 filament prongs of the plug. The secondary taps of the modernizing transformer should then be wired, in proper order, to the various lugs of the new filament selector switch.

The Separate Unit Modernizer will then be complete and, after testing, be ready for use. To use this unit, the tester's filament selector switch is placed (and left) in the "off" position, and the Modernizer cable is plugged into the tester's 4-prong socket. Then all adjustments are made as before, except that the filament selector switch on the Modernizer is used instead of the filament selector on the tester itself. See Fig. 3.

If the tester has no provision for loctal or bantam-base tubes, these can easily be installed at this time. All one need do is to obtain the proper sockets and to mount them on the tester panel. Then simply wire the new sockets in parallel with sockets, originally in the tester, having the same number of terminals.

A very handy feature too is a pilot-light tester. They require very little room and are easily installed. Simply obtain 1 screw-base socket and 1 bayonet-base socket for flush panel mounting and mount them on the tester panel. Wire them together in parallel and then wire the 2 leads in parallel with the filament terminals of the nearest tube socket. Different voltages will then be applied to each of the pilot-light sockets by the tester's filament selector switch. This tester will, of course, also test flashlight and Xmas-tree lights.

Any competent Serviceman should be able

to modernize almost any tester in an evening or two—and at a cost of about \$5.

NOTES

BUILT-IN TYPE

(1) Note instructions and diagram which come with the modernizing transformer.

(2) Follow original wiring through the Filament Return selector switch (if the tester has one).

(3) Make sure the filaments of the tester are wired in parallel.

(4) If the tester uses a separate filament transformer, disconnect and remove this transformer, replacing it with the modernizing transformer.

(5) If the tester does not have a separate filament transformer, cut the filament secondary taps. Wire the secondary tap leads of the modernizing transformer to the new filament selector switch, then wire the new switch to the original wiring of the tester. Connect the primaries of the 2 transformers in parallel.

SEPARATE UNIT TYPE

(1) Note instructions and diagram which come with the modernizing transformer.

(2) Follow the original wiring through the Filament Return selector switch (if the tester has one).

(3) The filament selector switch on the tester must be left in the Off position whenever the modernizer is in use.

(4) Do not alter or disturb the wiring of the tester.

ILLEGAL RADIO SEIZED AT RACETRACK

A MONTH'S search by the Federal Communications Commission for unlicensed radio equipment which broadcast "sure tips" to favored bettors while horse races were still being run was climaxed last month by the arrest of 2 men and the seizure of illegal apparatus at the Charles Town, W. Va., racetrack!

In early December Commission field men discovered that 2 portable transmitters were surreptitiously being put to such use. One transmitter concealed under the coat was employed by one of the men in the grandstand to communicate progress of the race to an accomplice in a rented tourist cabin near the track. The latter utilized the 2nd set to flash the expected result to conspirators listening-in at outside receiving stations. Under this system, some persons were able to make advantageous bets before the results of the race were generally known.

The method of operation, as determined by Commission inspectors listening-in, was this:

At the start of the race a person could be heard whistling on a certain radio frequency, followed by the words "Oh Johnny" repeated several times, and then a few bars from such songs as "Beer Barrel Polka" or "Maryland, My Maryland" would be sung. As the race neared the finish the voice would suddenly cut in with a number, repeated until the race was completed. Immediately after this number was spoken, a stronger signal on another frequency was observed to repeat the same number perhaps 10 or 15 times, followed by such commonplace expressions as "testing" or "testing for modulation," and finally the words, "that is all." On checking the race results it was obvious that the number in question referred to the number of the winning horse.

By the use of highly specialized equipment and technique, the party in the grand-

Stands Out

BECAUSE IT STANDS UP!

Here's the instrument that has been leading the field for five years . . . and still is "tops" for radio servicing. That's because it measures in fundamental quantities . . . no trick circuits or gadgets to cause early obsolescence . . . and because it is designed and built to high WESTON standards. It is an instrument that, with usual instrument care, will remain serviceable indefinitely. Be sure to get full information on this complete, inexpensive test instrument. Write for bulletin describing Model 772 and other WESTON instruments for radio and television servicing. Weston Electrical Instrument Corp., 599 Frelinghuysen Avenue, Newark, N. J.

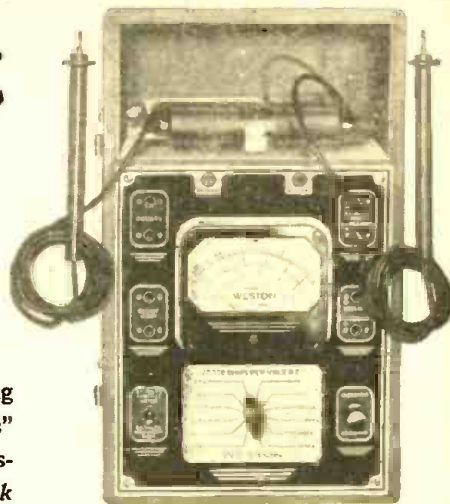

WESTON Model 772 Super-Sensitive Analyzer

RANGES

- Volts... DC—2.5/10/50/250/1000... sensitivity 20,000 ohms per volt.
- AC—2.5/10/250/1000... sensitivity 1000 ohms per volt.
- Current... DC—.1/1/10/50/250 milliamperes 1/10 amperes
- Ohms... 0-3000; 0-30,000 ohms . . . 0-3 megohms; 0-30 megohms
- Decibels... -14 +2/-2 +14/+12 +28/+26 +42/+38 +54

WESTON Radio Instruments

stand operating the transmitter concealed on his person was finally located. This transmitter was adjusted to an ultra-high frequency and the microphone extended down into the sleeve of the overcoat worn by the operator. To speak into the microphone, he merely raised his hand to the back of his neck and appeared to be conversing with his look-out companion, or shouting for his favorite horse to win. To allay suspicion, he carried a program and consulted it between races.

The grandstand tip-off man had a clear view of the tourist camp in which the high-powered transmitter was located, and received acknowledgements of the reception of his transmission by light signals flashed by the operator at the tourist cabin. On one occasion, the operator in the grandstand remarked on the air that a clothesline obstructed his view of the light. This announcement enabled the inspectors to verify the exact cabin in the group where the presence of the high-powered radio transmitter had been previously located by a radio direction finder, even though the antenna was concealed. This transmitter was built into a trunk and when the lid was closed gave no semblance of a radio apparatus.

Arrests were made in cooperation with the West Virginia State Police and United States District Commissioner at Martinsburg, after evidence had been presented by members of the Commission's field operations section personnel—Charles Ellert, Supervisor of the Central Atlantic Monitoring Area; Assistant Monitoring Officer Earl M. Johnson, and Radio Operator Kenneth B. Menear.

It's a SOUND idea to reserve your May issue NOW because it's a SOUND issue.



Wet ELECTROLYTICS

- High capacity in minimum bulk; ability to take severe punishment; instant self-healing or reforming of dielectric film following breakdown due to excessive voltages—these factors account for the growing popularity of wet electrolytics. • Meanwhile, the elimination of such drawbacks as leakage and seepage, and inadequate venting, heretofore associated with this type, accounts for Aerovox "wets" as the first choice. • A trial will convince you.
- Ask Your Jobber . . .

Ask for these Aerovox "wets." Try them in that "rig" you are building, especially in filter circuits subjected to surges. Ask for latest catalog—or write us direct.



SOUND ENGINEERING

*Free Design and Advisory Service
For Radio-Craft Subscribers*

Conducted by A. C. SHANEY

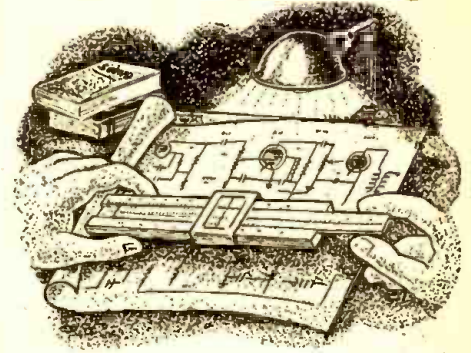

This department is being conducted for the benefit of RADIO-CRAFT subscribers. All design, engineering, or theoretical questions relative to P.A. installations, sound equipment, audio amplifier design, etc., will be answered in this section. (Note: when questions refer to circuit diagrams published in past issues of technical literature, the original, or a copy of the circuit should be supplied in order to facilitate reply.)

No. 16

ELECTRIC GUITAR AMPLIFIER

The Question . . .

Your writings on amplifiers are read with a great deal of appreciation each month.

I have a problem that is elementary, but nevertheless, one that has had me stumped for 6 months. In attempting to build a small, compact amplifier to use with an electric guitar, it seemed a simple matter for me to assemble the following tube lineup into an A.C.-D.C. job with an output of about 4 watts: 6J7 input, 6SC7 inverter, 2-25L6 as output and 2-25Z6s in parallel, connected for half-wave. All filaments in series should make it unnecessary to use a resistor in the 115-volt line. Would you mail me a hookup using the above tube lineup which would give me the maximum results from the 25L6s in output? My trouble has been lack of volume, and distortion. Would it be better to use 6C5 and an interstage transformer instead of the 6SC7?

D. T. WINSLETT,
N. Sacramento, Calif.

The Answer . . .

Requests for circuit diagrams can not be supplied to individuals by this department through the mails. All such inquiries are

answered in rotation and in order of their general reader interest.

A simple and straightforward circuit diagram of the type you desire is indicated in Fig. 1. Although a 6J7 is indicated, a 6SJ7 will simplify construction by eliminating the necessity of using a shielded grid cap.

All grounded leads need not be connected to the chassis proper unless adequate precautions are taken to insulate the chassis from personal contact. Otherwise, the chassis may become "hot" in relation to external grounds.

You will note that a 30-ohm resistor is inserted in series with all heaters. This precaution is taken for 2 reasons:

- (1) To bring the total required voltage to approximately 118 volts instead of 112.6, as the former more nearly approaches average mean line voltage.
- (2) The series resistor acts as a current limiter so that excessive currents can not flow through the heater circuits, when the voltage is applied while all heaters are cold. Excessive heater currents have been known to displace, or sometimes eject the heater from its normal position.

This amplifier will produce appreciable

distortion if the output is pushed beyond 4 watts.

While a 6C5 with a properly-designed transformer may produce less distortion at the 4-watt level, it will reduce the overall gain of the amplifier by approximately 8 db. As the amplifier hasn't too much gain for some low-level electronic instruments, the use of a transformer and loss of gain is not indicated (unless an additional stage is added).

The dependability of the A.C.-D.C. Audio Amplifier circuit indicated in Fig. 1 can be improved with a slight sacrifice in power output by inserting four 30-ohm resistors in series with each plate of both 25Z6 rectifiers. These resistors will limit the plate current of the rectifiers should the amplifier be turned off long enough for the input 20 mf. condenser to discharge, but not long enough for the rectifiers to cool. Under such conditions of operation, a large instantaneous peak current will flow when the amplifier is turned on again. This large charge current, while flowing for a relatively small time only, may damage the rectifier tubes.

Note: Only half the usual number of questions have been answered this month because of the Sound Editor's limited time. Mr. A. C. Shaney has devoted the services of his laboratory to the U. S. Government for the solution of knotty electronic and amplifier problems in connection with the present Defense Program.—Editor

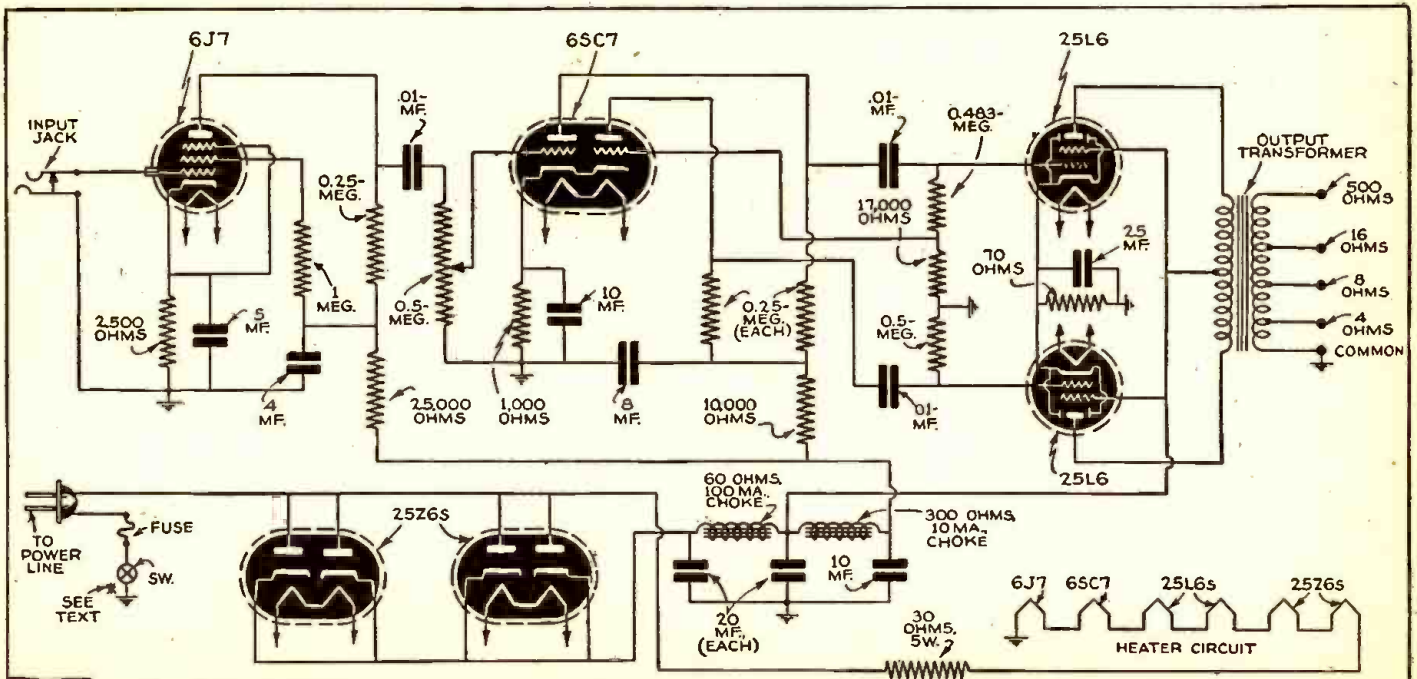

FIG. 1 ~A.C.-D.C. AMPLIFIER~

HERE'S THE NEW

Jensen

"Speech Master"

REPRODUCER



FOR DESK, WALL OR PANEL MOUNTING

ATTRACTIONAL streamlined appearance, versatile utility, and exceptional acoustic performance are capably combined in the new JENSEN "Speech Master"—designed especially for highly effective speech reproduction at moderate levels. Efficient, fully-enclosed PM structure. Rugged moving system. Internal provision for transformer mounting.

Desk Type . . . complete with base . . . "tilt" adjustment . . . for desk or wall mounting . . . List Price \$9.95.
Panel Type . . . for rack or cabinet assemblies . . . List Price \$8.10.

Bulletin 106 gives complete details.

Especially Designed for
Radiophone Communication
 Airline—Police
 Aviation—Commercial
Intercommunication
 One-Way & Talk-Back

Paging Systems
 Low-Level Stations

Public Address
 Low-Level Extensions

Jensen
 6601 SOUTH LARAMIE AVENUE - CHICAGO
 CABLE ADDRESS: JERAD, CHICAGO
 R E P R O D U C E R S

SERVICEMEN'S DEADLINE — March 29 at 3:00 A.M.

MARCH 29, many radio set owners will wake up to find that radio has played them a nasty trick.

Dial twiddling may reveal that station so-and-so has hopped up 10, 20 or 30 kc. on the dial—or maybe it will be down 10 kc.—or maybe it will be at some entirely different point on the dial!

After 3 A.M., on that eventful day in radio history, only about 80 stations out of a total of 862, in the new, wider broadcast band of 550 to 1,600 kc., will be found at their old frequency settings, thanks to re-allocation of wavelengths required by the Federal Communications Commission in accordance with international agreements made some time ago at the conference in Havana, Cuba. Purpose?—to clear broadcast channels of interference between national and international stations.

Radio-Craft presents here, Table I, the only listing of the changes as they will take place which is possible at this time. The Federal Communications Commission ad-

vises that so far it has released no list of old vs. new frequency allocations. Therefore, we suggest that Servicemen closely watch their local newspapers for station changes, near the "deadline" and subsequently, in their area.

TABLE I
SCOREBOARD OF FREQUENCY REALLOCATIONS
(Total number of broadcast stations affected . . . 862)

Number of Stations Affected	Nature of Change (if any)
80	No Change
20	Move up 10 kc. (1 channel)
25	" " 20 " (2 ")
619	" " 30 " (3 ")
19	" " 40 " (4 ")
64	"down 10 " (1 ")
35	Irregular Shifts

Latest estimates by the National Association of Broadcasters place the number of

radio sets in use at about 50,100,000. Every one of these sets is affected by the reallocation, and hence, is a potential service job! About 9,000,000 to 10,000,000 are push-button-tuned receivers which Servicemen can offer to re-set at a nominal charge (an entrée to repairs and the sale of tubes, etc.).

One well-known manufacturer has devised a "Station Allocator"—an A.F.-modulated R.F. oscillator with pushbuttons set for local stations—to help Servicemen cover a lot of ground . . . fast. That's your tip-off for getting a goodly share of the big "Re-allocation Business", Mr. Serviceman—**SPEED.**

First effect of the reallocation will be rush calls for the Serviceman to readjust pushbuttons, since only a small proportion of pushbutton home- and car-radio sets can be properly set by the owner or the handyman. Here is an immediate source of income. At the same time the need for new tubes, antenna installations, immediate re-

(Continued on page 612)

MODERN MICROPHONE TECHNIQUE

In this concluding article, in a series of 3 on the choice and use of microphones (and on amplifier input considerations) in Public Address work and Home and Semi-Professional Home Recording, the fine points in the actual use of microphones are discussed. The February issue, Part 1, The Microphone, described the mechanics of these units. Part 2, The Microphone and Its Relation to the Amplifier, in the March issue, described the very important considerations of this relationship. From any angle, Microphone Technique must be considered a controversial subject. Too great in scope "even for a book," to quote the authors, it is hoped that this series has aided in some measure to sum up some of the ideas which are in current belief and use today.

PART III—The Microphone in Action

L. FLETCHER and H. S. MANNEY



A non-directional microphone picks up the voices of 4 speakers at a round table discussion.

(Photo—Courtesy C.B.S.)

IN THE foregoing two articles of this series, we have attempted a discussion of the ingredients which go into the making of every-day, all-round Microphone Technique. Given the proper slant upon the selection of the microphone itself and its relationship to the amplifying equipment, we now come to the final phase in our theme—which concerns the microphone in action.

"Microphone technique," as such, seems to be a controversial subject from every angle, for here again, in treating this very complex question of microphone handling, we must qualify our discussion by saying that there are *no infallible* rules, as far as microphone set-ups are concerned. Of course there are certain fundamentals which must be observed—but at the same time, *the varied and innumerable circumstances under which a microphone is called upon to function, in themselves preclude the laying down of any hard and fast laws.*

In the following article, we shall attempt to define whatever fundamentals of technique exist—and wherever possible, indicate exceptions. It is hoped, however, that each engineer reading the article will use these statements only as a starting point, supplying for himself those peculiar and individual cases which cannot possibly be covered in so limited a space.

P.A. TECHNIQUES

And so, let us say we have selected the proper microphone for our purpose, and matched it with suitable amplifying equip-

ment. How shall we go about installing it, say, in a *public address* system designed for indoor public entertainment?

There are two main things to be considered when one is setting up a microphone in a public address system. One is its relationship to the performer; the other, its relationship to the loudspeakers.

Both matters are closely inter-related, for the distance between the performer and the microphone is vitally affected by the distance between the microphone and the loudspeakers. For example, the closer the reproducers are placed to the microphone, the closer the performer will have to work to it, in order to hear himself without interference.

Loudspeakers should never be placed any closer to the microphone *in front* than 3 or 4 feet. They should never be placed behind the microphone. If necessary to place them on the same level as the microphone, they should be set as high in the auditorium as possible, preferably in a proscenium arch or on some projecting ledge overhead, and they should be tilted out, and away from the microphone below.

Their sideways distance from the microphone should be as far away as is compatible with maintaining the proper illusion—that is, that the voice is coming from the performer himself. In other words, it is better for the performer if the speakers are far away from him, for he can move about more, and he suffers less from hearing his own voice coming back at him—but at the same time, too great a distance would ruin the whole idea of the P.A. system. The

performer would appear like a mouthing puppet, with little or no connection to his own voice, booming through the hall.

There are no rules about the proper sideways distance for the maintenance of this necessary illusion—inasmuch as stages and halls differ so tremendously. Tests must be made beforehand, until the correct placement is found.

PROXIMITIES

Today, performers using P.A. systems have fallen into the extremely bad habit of working far too close to the microphone, and performances are suffering as a result. "Mike-grabbing" and "mike-hugging" are two notorious faults, which bring sorrow to the P.A. men. One sound man interviewed declared that lady performers now work so close to the microphone that they even leave lipstick on it after the performance!

This is a sad state of affairs for two reasons. The first is that the velocity microphone "booms" and growls in the lower registers, causing extreme distortion in the tone when performers come too close. The second is that when a performer works too close to the microphone, any sudden movement backwards of 3 or 4 inches, let us say, brings such an appreciable drop in the volume level that it is almost impossible for the engineer to compensate for it quickly at the amplifiers. Hence the so-called unevenness of many modern pick-ups. The ratio of sound pick-up to distance in a microphone is not like that of a human ear. *When the distance is increased one-half, the sound loss decreases in proportion to the square of the distance.* On the other hand, if the performer is at a reasonable distance to start with, a slight backward movement will not make so much difference. This goes for *any* type of microphone—velocity, dynamic, or crystal.

A distance of about 1 ft. away from the microphone seems to produce the best effect, no matter what the mike type is. This, of course, applies to the normal voice. People with louder voices can work farther away. At Roxy's and the Radio City Music Hall, powerful operatic baritones have been known to stand 6 or 8 ft. away from the microphone, and still not sound faint. If the gain on the microphone's amplifier is increased, even a normal voice can be picked up with fair clarity 2, 3, or even 4 ft. away. "Reinforcement" microphones used in theater work among the footlights are seldom any closer to the performers than 6 feet, yet they are able to reproduce voices, singing and tap-dancing successfully, provided their output level is high.

In any case and for any microphone, no performer should be allowed to come any

closer than 6 inches. Even in the crystals and dynamics, the sound is garbled and the voice hisses, when performers work closer than this distance.

"And supposing the performers *won't* stand back?" wail the men. Well—in some cases, very little can be done about this, particularly in the fly-by-night single jobs so many P.A. engineers are called upon to do. But then again, there's no harm trying—and on such jobs where the engineer has a chance to influence and advise performers, a word here and there might eliminate some of the difficulty, and at the same time set a good example for the others.

In all public address work the microphone should never be on a level with the performer's face. Any P.A. system which concentrates the audience's attention on the microphone rather than on the performer is bad. The microphone should be placed *below* the performer's mouth, on a level with the bottom of his chin, and he should talk *over* it. His face should be completely visible to the audience.

INSTRUMENTALISTS

If the performer is an instrumentalist, a slightly greater distance from the microphone should be maintained. About 2 ft. away is good for a violinist, 3 ft. for the other instruments. In all cases the mike should be tilted toward the sound-source—that is, toward the instrument's sounding-board rather than the performer. The piano, as a solo instrument, of course requires special care, and the placement of the microphone in relationship to it has always been a matter of considerable discussion among public address circles. Some sound specialists find that a good pick-up for a grand piano is achieved by placing the microphone as close to the open sounding-board as possible, tilting it down toward the strings. Others place the mike near the player's right shoulder, tilting it toward the mouth of the player. The upright is still more difficult to "mike" than the grand, due to the fact that its sounding-board is encased in such a way that sound-waves coming from it are muffled. One method is to open the top of the instrument, and hang a microphone on a goose-neck stand just over the aperture. Another P.A. man using a crystal and dynamic microphone found that these two mikes placed close to the upright *behind* the instrument achieved very satisfactory results. It is largely a matter of individual preference and experiment.

It is perfectly possible to pick up an orchestra or a vocal ensemble with a single microphone, provided the microphone is placed so that its angle of pick-up includes all the instruments or voices. The cardioid or the uni-directional velocity are best for this type of work, as they have the maximum angle of pick-up of any microphone. Distance from the sound-source will of course depend upon the size and grouping of the ensemble. Thus for a small group, closely squeezed together, the mike may be placed only 3 or 4 ft. away—for a large symphony orchestra, 30 ft. away. If a bi-directional velocity is used, the ensemble should be divided in half and grouped on either of the "live" sides, with the weaker instruments in front. If a crystal or dynamic is used, the group should be placed in a semi-circle around it, and the mike tilted horizontally, facing the ceiling, so as to achieve an approximately 360° angle of pickup.

Most large musical groups, however, particularly bands, require more than one microphone for the pick-up, otherwise the tone of the weaker instruments is lost. The cardioid comes nearest to picking up a fair, clear balance among the instruments, but

Two ribbon microphones—their sensitivity to sound decreases towards the axis along which the 2 flat sides are joined—arranged for dance orchestra and vocalist. One (far left) picks up sounds from the string section of the large orchestra; the other (right) is for the singer. The technicians in the control room adjust the amplification levels to balance the singer's voice against the orchestra.

(Photo—Courtesy C.B.S.)



even when this mike is used, some extra reinforcement of particular sections or instruments is often required. The piano and the lighter stringed instruments, such as the guitar and mandolin can usually stand an extra microphone, especially if they are to be used for solo work. A great many bands are now using the so-called *contact* microphone for this—the microphone, a small crystal, being attached to the instrument's sounding-board by means of tape or vacuum cups, and individually amplified at equipment on the stage. This type of microphone requires a special technique of handling on the part of the individual musician, the P.A. man, but it has often saved the day, when an ordinary dynamic or velocity mike would not do the trick of reinforcement. It should be placed near the instrument to be amplified, about 3 or 4 ft. away, and used only when the ensemble of the orchestra seems to require it.

Any soloist with an instrumental group should of course have his own microphone—which should be placed so that it picks up the ensemble tone as background and the voice as foreground. The regular orchestra microphone can be regulated with this at the mixing panel.

THEATER P.A.

Many theater sound set-ups require more than one microphone, indeed, in most large vaudeville houses, a battery of reinforcement mikes as well as a number of regular mikes for the various performers are always used. In installing a set of reinforcement microphones in the footlights, it is best to use one of the types which is "dead" at the back, in order to avoid pick-up of orchestra playing, audience applause, etc. If a bi-directional type is used, it should be covered at the back with a swivel housing of felt. Also, the microphone should be mounted on some shock-absorption material, such as a soft grade of rubber, in order that it will not be affected by the foot-steps of the performer, sudden jars, etc. It should be tilted toward the performer's face. As noted before, the sensitivity should be very high on these mikes, as they often have to function 8 or 9 ft. away from the performer. The number of mikes used in one of these reinforcement systems depends upon the size of the stage, but for the average theater, 3 or 4 microphones are plenty.

The disappearing microphone, which rises and descends from the floor of the stage as it is needed, is another important factor in theatrical P.A. work, although, due to the expense involved in most installations, few but the largest theaters possess one. Any

type of microphone can be used for this purpose; as usual, however, the uni-directional type is preferable, as the angle of the mike must remain fairly permanent. The microphone is mounted on a stand, which cannot be any longer than the space below the stage floor. Two types of mechanism are at present being used to raise and lower the stand. The simpler method is to use a hand sprocket and wheel, which is operated from below the stage, or from the wings, by hand. Most of the theaters, however, prefer a mechanism which works by electricity, and can be controlled by a pushbutton on the backstage switchboard. When the microphone disappears below the stage, a flap automatically covers the opening. Both methods are costly, the hand method alone costing about \$1,000 to build and install.

Outside of theater work, few sound jobs require the concealment of the microphone. If they do, the ingenious engineer can usually find a way of hiding the mike among the entertainment apparatus—hiding it in vases, bowls of flowers, concealing it among potted palms and ferns—even pinning it to a curtain, or strapping it to a lampshade.

Outdoors, the placement of the microphone is very similar to its handling indoors, although in most cases, the performer must work a trifle closer to it. The main problem outdoors as far as the microphone is concerned, is to guard it against the elements. Thus, if the day is windy, it is wise not to use a velocity type unless it is equipped with a *wind screen*. This consists of a perforated cylindrical screen backed with a very thin open-weave cloth, placed about 2 inches in front of the microphone. Such a screen will break a stiff breeze, but at the same time will not muffle the regular pick-up of the performance. The crystal mike should be watched for too much heat, as its crystals melt at a temperature of 125° F.; and for rain, which melts them, too.

SOME PROFESSIONAL "DON'TS"

Although most P.A. engineers agree that they seldom get a chance to tell performers what to do, here are a few tips on the proper handling of oneself before a microphone, as supplied by engineers and professionals.

- (1) Don't work any closer than 1 ft. from the microphone, and don't grab the microphone stand. Mike-grabbing doesn't do the mike any harm at the moment, but if you grab the mike, you may forget and start to walk around with it, trip over the cable, or otherwise detach the instrument from its amplifying apparatus. This would automatically cut

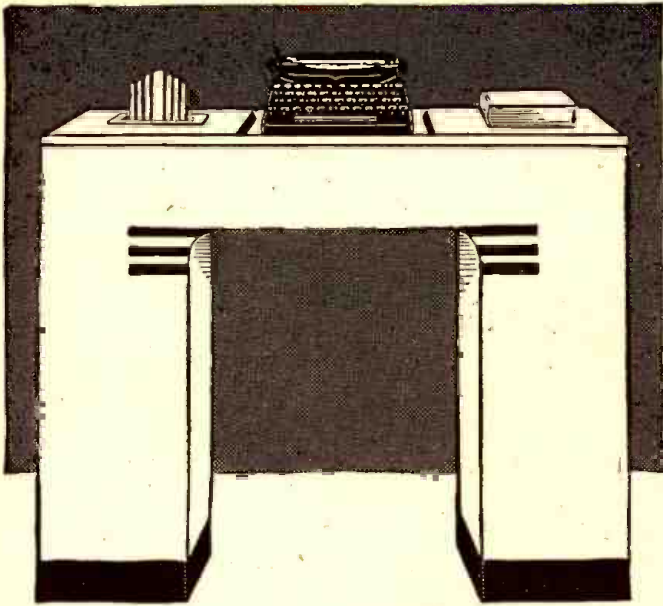

**THIS
BEAUTIFUL DESK
for only \$1.00 EXTRA**

**WITH ANY
REMINGTON
PORTABLE TYPEWRITER**

The
COMBINATION
FOR AS LITTLE AS
10¢ A DAY

How easy it is to pay for this combination of desk and Remington Deluxe Noiseless Portable Typewriter! Just imagine, a small good will deposit with terms as low as 10c a day to get this combination at once! You will never miss 10c a day. Yet this small sum can actually make you immediately the possessor of this amazing office at home combination. You assume no obligations by sending the coupon.

A beautiful desk in a neutral blue-green which will fit into the decorations of any home—trimmed in black and silver—and made of sturdy fibre board—is now available for only one dollar (\$1.00 extra) to purchasers of a Remington Noiseless Portable Typewriter. The desk is so light that it can be moved anywhere without trouble—it is so strong that it will hold six hundred (600) pounds. With this combination of desk and Noiseless Deluxe Portable Typewriter, you will have a miniature office at home. Learn the complete details of this offer. Mail the coupon today.

THESE TWO EXTRA FOR YOU

LEARN TYPING FREE

To help you even further, you get free with this special offer a 32-page booklet, prepared by experts, to teach you quickly how to typewrite by the touch method. When you buy a Noiseless you get this free Remington Rand gift that increases the pleasure of using your Remington Noiseless Deluxe Portable. Remember, the touch typing book is sent free while this offer holds.



SPECIAL CARRYING CASE

The Remington Deluxe Noiseless Portable is light in weight, easily carried about. With this offer Remington supplies a sturdy, beautiful carrying case which rivals in beauty and utility the most attractive luggage you can buy.



SPECIFICATIONS

ALL ESSENTIAL FEATURES of large standard office machines appear in the Noiseless Portable—standard 4-row keyboard; back spacer; margin stops and margin release; double shift key and shift lock; two color ribbon and automatic ribbon reverse; variable line spacer; paper fingers; makes as many as seven carbons; takes paper 9.5" wide; writes lines 8.2" wide. There are also extra features like the card writing attachment, black key cards and white letters, touch regulator, rubber cushioned feet. These make typing on a Remington Deluxe Noiseless Portable a distinct pleasure. Thousands of families now using the Remington Deluxe Noiseless Portable know from experience how wonderful it is!

MONEY BACK GUARANTEE
The Remington Noiseless Portable Typewriter is sold on a trial basis with a money back guarantee. If, after ten days trial, you do not wish to keep the typewriter, we will take it back, paying all shipping charges. You risk nothing in buying a Remington Portable Typewriter on terms as low as 10c a day.



**MAIL
COUPON
NOW!**

Remington Rand Inc., Dept. 189-4
465 Washington St., Buffalo, N. Y.

Tell me, without obligation, how to get a Free Trial of a new Remington Deluxe Noiseless Portable, including Carrying Case and Free 32-page Typing Instruction Booklet on terms as low as 10c a day. Send Catalogue.

Name.....
Address.....
City..... State.....

your performance off P.A. *Let the mike alone.*

- (2) Don't address the microphone. Talk to your audience. You are not broadcasting. The sound system is only there to enable them to hear you better. You don't have to shout at them. Just address them quietly, as though they were a couple of feet away, in a pleasant, conversational tone.
- (3) If you are a singer and you're about to sing a very loud passage in your song, or hit a very high, loud note, back away a couple of inches from the microphone or turn your head slightly to one side. This will prevent your full tone from hitting the microphone directly in these loud parts. Of course the engineer at the amplifier can moderate your loud tones for you, but it's easier and produces a better effect, if you anticipate them yourself. For soft passages, move in a little closer to the mike. This goes for speakers, preachers, etc., who wish to change the volume of their voice suddenly.
- (4) Don't rattle your script when standing before the microphone. Make as few extra noises as possible. Try not to breathe directly into the microphone.
- (5) Pronounce such consonants as *t, k, d, p* lightly. These sounds have a tendency to crackle in the amplifier, when over-stressed.
- (6) Don't listen to your own voice coming back through the loudspeakers. This is fatal. You can't possibly hear your own voice, as it sounds to the audience. Even if there is a slight reverberation, pay no attention to it. Go on, as though no P.A. system were in effect.

SEMI-PROFESSIONAL RECORDING

Mike technique for semi-professional recording is considerably different from public address technique, inasmuch as there is no loudspeaker problem involved, and the acoustics of the room are more easily controlled. Usually, as we have pointed out in the first article of this series, the studio is a fairly "live" one, the general trend nowadays in this type of work being to achieve more normal acoustical conditions rather than the old over-treated ones of the past. There are still many companies, of course, where the older kind of acoustical treatment persists. First, however, let us consider the proper microphone set-up for a normal "live" studio, using a velocity microphone.

In such a case, the microphone may be set up in any part of the studio convenient. The performer, as in P.A. work, should stand no closer than 12 ins. away from the microphone. "Heavier" voices may be placed farther away, sometimes even several feet away. The recording engineer has one distinct advantage in this respect over the P.A. man, for the nature of this work permits him to make a test of the voice beforehand, and he can place his performer accordingly. Unlike the public address engineer, he can also anticipate the loud and soft passages more accurately. When making the test, he should watch his decibel meter for the loudest passages, and then in performance, set the swing of his volume indicator for those passages, letting the soft ones take care of themselves.

Of course he will be helped considerably, and will make a better recording, if the performer is also asked to co-operate on the louds and softs, by stepping back or forward a little, as the case may be.

In recording work, the microphone should be placed in line with the performer's mouth, and tilted so that his full tone

15 WATT AMPLIFIER at \$10.75 GIVES 3100 HOURS *Continuous* SERVICE —AND STILL GOING STRONG!



Read This Amazing Letter

MUELLER-O'NEIL COMPANY
Amplifier Engineers
570 Jerome Avenue
St. Louis, Mo.

CHECK THESE FEATURES

- EXTRA HEAVY CHASSIS
- COMPLETELY SHIELDED
- ALL OVERSIZED COMPONENTS
- SIX TUBE CLASS A PUSH-PULL
- FIFTEEN WATT OUTPUT
- THREE INPUT POSITIONS
2 Microphone, 1 Phono Input
- 2-4-8-500 OHM OUTPUTS
- HIGH GAIN, WIDE FREQUENCY RESPONSE
- CONTINUOUS, VARIABLE TONE CONTROL
- FOUR STAGES OF AMPLIFICATION
- TUBE LINEUP 1-6SJ7, 2-5C7, 2-6N6, 1-83V
- OPERATION ON 110-120 Volts. 50-60 CYCLE
- LIST PRICE \$24.50—YOUR COST ONLY \$10.75 (less tubes)

BUY THE BEST FOR LESS!

Don't let our low price fool you! When you buy a TokFone Amplifier you're buying QUALITY. Mr. O'Neil's letter and many others like it prove that you need not pay high prices to get High Quality.

10.75 FOR AMPLIFIER
Less Tubes F.O.B. N.Y.
(Kit of Matched Tubes add \$4.50)

A COMPLETE ALL-PURPOSE SOUND SYSTEM FOR ONLY \$32.50

The amplifier described above may be purchased alone or as part of the Complete TokFone Sound System. Here's what you get:

	LIST PRICE
15 Watt Amplifier as Described	\$24.50
2 12" Speakers @ \$7.50 each	15.00
2 Wooden Speaker Baffles @ \$10.00 each	20.00
1 Crystal Microphone with Desk Stand	12.50
1 Kit of 6 Matched Tubes	9.30
TOTAL	\$81.30
For amplifier screen cover add \$2.25	

MAIL COUPON TODAY!

Gentlemen, We have five of our 15 watt amplifier systems working 24 hours a day here at the Union Station in St. Louis for giving instructions to trainmen. Two of these systems have been in use continuously since July 22nd 1940. The sets have never been turned off. We even had to change up more than 15 seconds.

There are 14 horns connected to this system spread over 6 city blocks and 2 inside speakers located in make-shift shelters along the tracks. The noise level is terrible when trains are passing, and the volume this requires a lot of volume. The noise is as a noise compared to this noise we have to work through.

To cut off the amplifier when not in use I use a toggle switch shorted across the output. The best this is cut in and out.

This installation required dependable equipment and your TokFone amplifiers came thru in great shape.

Yours very truly,
Donald McNeil
Mueller O'Neil Co.
Western Electric Customer Deal Extensively

Regal Amplifier Mfg. Co.
16 West 17th St.
New York City

- Send me 15 watt amplifiers at \$10.75 (less tubes)
- Send me 15 watt sound systems @ \$32.50 (less tubes)
- Send me kits of matched tubes @ \$4.50
- Send me screen covers @ \$2.25
- Send me complete illustrated catalog and price list.

Name

Address

City State

strikes it directly. The main thing desired is a clear, clean-cut reproduction, and the performer should devote his full attention to the microphone—in contrast to public address work, where most of his attention must be given to the audience.

INSTRUMENTAL PICK-UPS

In recording instrumental and vocal ensembles, the same set-up may be observed as in sound work—with the exception that the engineer usually has more time to experiment with unusual grouping of his instruments, as well as the use of more than one type of microphone. Thus, for a recent semi-professional recording of a piano quintet, the engineer used 2 microphones to pick up the 5 instruments—a *velocity* for the string quartet, which was so placed that the *velocity* also caught part of the piano tone,

and a *dynamic* microphone placed about 5 ft. away from the piano, which was used only when the piano played solos or "rode" the string quartet.

The piano, of course, is a problem in this type of work as in any other. A good mike set-up for a piano recording with a velocity microphone is to set the mike on a stand about 5 to 8 ft. away from the curved inner part of the sounding-board. The top of the piano should be kept open. Uprights are more difficult to record, but since they are seldom used in the better recording studios, they need not be discussed here. If used at all, the top of the instrument should be kept open for greater brilliance, and the microphone placed over the aperture on a goose-neck microphone, or close to the bass part of the keyboard.

All of the smaller recording studios today

THE FINEST RADIO BOOK FREE

WE EVER OFFERED :-
the 1940-41 Radio-Television Reference Annual
With \$1.00 subscription to
RADIO - CRAFT

WITH our compliments, we want to send a copy of the 1940 RADIO-TELEVISION REFERENCE ANNUAL to you FREE, if you will simply take advantage of RADIO-CRAFT magazine's special subscription offer NOW. This offer is being made for a limited time only.

The 1940 RADIO-TELEVISION REFERENCE ANNUAL has 68 pages, large size 8½ x 11½, with over 170 illustrations. The contents of this book has never appeared before in handy book form. Its pages cover practically every branch of radio sound, public address, servicing, television, construction articles for advanced radio men and technicians, time and money-saving kinks, wrinkles, useful circuit information, "ham" transmitters and receivers, and a host of other data.

The Annuals have always been regarded as a standard reference work for every practical branch of radio operation and service. This 1940 edition ably sustains this reputation. Every radio man wants a copy of this valuable book. Just as this book will be of unquestionable value to you, so, too, will every monthly issue of RADIO-CRAFT. This magazine brings you big value every month. It keeps you intelligently informed about new developments in radio and television. You want the news, want it fully but concisely, want it first—that is why you should read RADIO-CRAFT regularly.

This very special offer is made for just one purpose—we want you as a regular subscriber. The Annual, whose contents appears at the right, is not sold, but a copy is FREE to you if you subscribe now.

**SAME SIZE AS
RADIO-CRAFT**



THIS COUPON BRINGS YOU THE ANNUAL

RADIO-CRAFT • 20 VESEY STREET • NEW YORK, N. Y.

Gentlemen: Enclosed you will find One Dollar for which enter my subscription to RADIO-CRAFT Magazine for Eight Months. Send me ABSOLUTELY FREE and POSTPAID, my copy of 1940 RADIO-TELEVISION REFERENCE ANNUAL.
 This is a new order Extend My Present Subscription

NAME ADDRESS

CITY STATE

DON'T DELAY — MAIL TODAY! RC-441

**Read the summary of contents
in this FREE BOOK!**

THE 1940 RADIO-TELEVISION REFERENCE ANNUAL contains a collection of the best and most important articles. Covering as they do nearly every branch of radio, they form a handy reference works. In addition, many time and labor-saving kinks, circuits and wrinkles, tried and tested by practicing Servicemen, experimenters and radio fans have been included. This book cannot be bought anywhere at any price. Yet it is Yours by merely subscribing. Use the convenient coupon below.

**BEGINNER'S SIMPLE INEXPENSIVE
CONSTRUCTION ARTICLES**

Beginner's Breadboard Special - a 1-Tube High-Gain All-Wave Receiver—Wiring Pointers for Radio Beginners—A Watch Charm Size 1-Tube Set—Beginner's Simple Volt-Milliammeter—Making a 1-Tube Broadcast Loop Receiver—A.C.-D.C. Power Supply for Battery Portables—A 1-Tube Short-Waver with Band Coil Switching.

MORE ADVANCED SET CONSTRUCTION

The "High-Seas 4" Broadcast Lamp Radio—How to Build a 6-Tube 1.4-Volt Short-Wave Superhet for the "Ham" or Short-Wave Fan—Build the "Lunch Box 5" Super Set a Broadcast Battery Portable—How to Build a Plug-Together 8 Tube Broadcast Set—The "5-in-4" All-Wave Radio for A.C. Operation—An Easily-Built 3-Tube Midget Broadcast Superheterodyne Receiver.

THE SERVICEMEN'S SECTION

Bass Tone Control—Simplified Variable Selectivity—Practical Servicing Pointers—Servicing Universal A.C.-D.C. Receivers—Killing the "Intermittent" Bug—A Service Shop A.C. to D.C. Power Supply—Sideline Money for Servicemen—Adding A.V.C. to any Screen-Grid T.B.F. Receiver—Iron Particles in Speaker Air Gap.

TEST INSTRUMENTS

A Useful Neon Lamp Tester—An Inexpensive Output Meter—Making Milliammeter Multipliers—Home-Made Frequency Modulator—The Busy Servicemen's V.T. Volt-Meter.

PUBLIC ADDRESS AND AMPLIFIERS

Build this Combination A.C.-D.C. Radio and Inter-Communicator—Speaker Placement in P.A. Work—The Design and Construction of an Inexpensive All-Push-Pull 10-Watt Amplifier—Obscure Sources of Hum in High-Gain Amplifiers—How to Build a High-Fidelity 5-Watt Versatile Amplifier.

"HAM" SECTION

Ultra-High Frequency Antennas—The Beginner's Low-Cost Xmitter—Modulator Meter—Phone Monitor—The Beginner's "Ham" Receiver—2½ Meter Acorn Transceiver.

TELEVISION

How to Build a 441 Line T.R.F. Television Receiver—Useful Notes on Television Antennas.

MISCELLANEOUS

Simple Photo-Cell Relay Set Up—Making a Burglar Alarm—How to Build A.C.-D.C. Capacity Relay—How to Make a Modern Radio Treasure Locator.

USEFUL KINKS, CIRCUITS AND WRINKLES

Making a Flexible Coupler—Two-Timing Chime—A Simple Portable Aerial—An Improvised Non-Slip Screw-Driver.
NOTE: The book contains numerous other useful Kinks, Circuits and Wrinkles, not listed here.

(approximately)

45 ARTICLES

(approximately)

170 ILLUSTRATIONS

68 BIG PAGES

**RADIO-CRAFT
20 VESEY STREET
NEW YORK, N. Y.**

are not acoustically alive, however. If so, what microphone should be used, and how should it be handled in an over-treated, dead room?

The crystals and dynamics seem best for this type of work, as their high output tends to compensate for the dullness of the acoustics. Vice-versa, any room using a crystal or dynamic microphone should be acoustically treated, so that any possibility of the sound's ricocheting back from the walls or ceilings and being picked up by these highly sensitive, non-directional types is eliminated. In any case, the microphone should be placed as near as possible to some absorbing drapery. If the room is small, it should be draped on all 4 sides; if a medium-sized room, the drapes need be hung only in back of the microphone.

The performer may work much closer to the microphone in this type of set-up—6 ins. being a good general distance away for a well-modulated voice. Crystals and dynamics have a tendency to hiss if the performer comes too close, but in a dead room, if he gets much farther away than 6 ins., there is an appreciable loss in brilliance. As with the velocity, the performer should speak directly into the microphone, which should be tilted toward his mouth. Here again, by stepping back or turning aside a little, he can anticipate loud passages, and by stepping forward a little bring the softer ones into the audible range.

For an extremely powerful voice, the performer may stand a little off to one side of the microphone throughout the performance, not singing or speaking into it directly at all. This will deflect a good deal of the tone, and should only be used when the voice is too powerful to control in the amplifier, or when the room is too small to permit the performer's standing far enough away.

It is well to remember that when using a crystal or dynamic microphone, it is next to impossible to record a high voice in a small (9x12 ft.) room. The studio should be at least 10x15 ft. for this purpose.

String instruments are the easiest to record, either in the small commercial studio or at home. They have an even level, compared to the speaking or singing voice, and reproduce beautifully. When using a crystal microphone, they should be placed about 1 or 2 ft. away, and the microphone should be tilted, as in the velocity, toward the sounding-board of the instrument.

Horns are extremely difficult to record in a small studio, with a crystal microphone, and if handled, should be muted. When a vocal quartet is recorded, group the singers in a circle around the mike, which should be tipped up horizontally facing the ceiling. The stronger voices should be at the back. This applies also to a string quartet, or any small group of instruments.

When "miking" a piano with a crystal microphone, the microphone should be set up as close to the sounding-board as possible. Of course the lid of the piano should be raised. The crystal has a tendency to garble piano tone if too much pedal is used, so the performer should be urged to go as lightly on the loud pedal as possible. It helps in a set-up of this kind if the piano legs are mounted on mats of hard rubber between two slabs of sponge rubber.

One or two of the small commercial recording studios now use small contact microphones for the recording of piano solos. Attached to the sounding board, they pick up piano tones without the overtones due to the housing (this, to some, is an objection).

No extra microphone is necessary for a singer with a piano accompanist—which is a performance set-up so often encountered in semi-professional recording work. Care should be taken however that singer and

pianist do not get too far away from each other, particularly when a crystal microphone is used. The ideal set-up seems to be for the singer to stand in the inner curve of the grand piano, whose lid for this purpose should be kept closed; the microphone should be tilted toward the mouth of the singer, but by having it this close to the piano, it will incidentally pick up the accompaniment, keeping it in the proper proportion to the voice.

A test is of the most vital importance in all recording work of any kind, and no record should be made without a preliminary rehearsal. People are inclined to suffer from microphone fright in the recording studio more than in public address work (in P.A. work, as a matter of fact, the microphone works against stage fright, for it gives the performer something to concentrate on)—and so, when making a record, the technician should never rush into the matter pell-mell, but should rather make every effort to put the performer at his ease. In most recording studios, at least 15 minutes are spent in talking and testing the performer's voice before even the final rehearsal is made. This is a very essential part of microphone technique, and will show up on the final records every time.

HOME RECORDING

Most of the statements made above concerning the handling of a crystal microphone in a small dead studio can be applied just as well to the use of the microphone in home recording for conditions in both places are extremely similar.

As we have pointed out in the first article of this series, most family living-rooms with their over-stuffed furniture and heavy rugs and drapes are acoustically dead, and so are not ill-suited for the crystal microphones which manufacturers in general hand out with the average home recording sets. Thus, if the reader will refer back to the various set-ups mentioned above for such circumstances, he may be able to make more out of his cheap crystal mike than formerly. In all events, however, he should remember that for really satisfactory results the crystal must be used in an acoustically treated room. If extra drapes are hung, they should be placed in folds, to make them still more absorbent. For live rooms, a velocity microphone is better than anything, and in such a case, its proper handling has already been discussed in the first part of the section on semi-professional recording.

In paging and call work, where the voice being amplified is generally a well-modulated, rather quiet one, the only thing to watch is the performer's placement at the microphone—and in general, the same rules of distance apply—i.e., 1 ft. away for the velocity, 6 to 8 ins. for the crystals and dynamics.

Microphone Technique, as such, is a big subject to cover in a single series of articles. It would be a big subject even for a book. Indeed, no book could quite keep up with its ever-changing conditions. This series of articles has been merely an attempt to sum up some of the ideas—some fresh, some already slightly outmoded—which are in current belief and use today. Next year, next month—even next week—some of them may be quite meaningless. We have already seen the decline and fall of many different types of microphones and microphone equipment. Tomorrow may witness the decline even of such current favorites as the velocity and the dynamic. Whatever comes, however, there is one thing sure—and that is—that there will always be microphones of some kind—and men to work them. The less microphone technique required, of course, the better. Those very words—*microphone technique*—may some day be obsolete, too.

**New Direct-Coupled FM - AM
AMPLIFIER MANUAL**

By A. C. SHANEY
Chief Engineer, Amplifier Co. of America



**For the Layman, Serviceman,
Recordist and Engineer**

Regardless of whether you are interested in the finest type of phonograph reproduction, high fidelity recording, sound-on-film applications, FM or AM programs, you will find invaluable information in this practical handbook. Written by the leading exponent of direct-coupled amplifiers who has spent more than 10 years improving and perfecting the famous Loftin-White circuit. Describes and explains the theory and practical application of:

- Variable Speed Non-Overloading Push-Pull Expansion
- Non-Frequency Discriminating Scratch Suppression
- Push-Pull Balanced Direct-Coupled Amplification
- Push-Pull High-Frequency Equalization
- Push-Pull Low-Frequency Equalization
- Push-Pull Volume Compression
- Automatic Volume Limitation
- Automatic Volume Control
- Calibrated V.U. Indicator
- Audio Spectrum Control
- Remote Control

If you are interested in the latest audio developments, you can't afford to be without this complete compilation of authentic articles on Direct-Coupled Amplifiers. 82 Pages 8 1/2" x 11". Over 100 diagrams and illustrations.

Priced to Cover Cost of
Printing and Mailing **20c**
Send Stamps or Coin

AMPLIFIER CO. of AMERICA
17 WEST 20TH STREET, NEW YORK, N. Y.

Simplified Home Recorder

**Keeps Cost Low,
Is Easy to Use**

**New!
GI-R70**



- Simple operation, down-to-earth price and quick, easy installation make this popular home recorder an outstanding buy. Precision built. Special-design, sturdy motor and weighted turntable with retractable record-driving pin; concealed feed screw; best-quality cutting head; high-impedance, tangent-tracking crystal pickup. Get a GI-R70 to test—order from your regular Jobber.

The GENERAL INDUSTRIES CO.
DEPT. 20 ELYRIA, OHIO



HIGH EFFICIENCY!
University Reflex Speakers will project sound clearly for two miles with less than 25 watts input. Write for catalogue.
UNIVERSITY LABORATORIES
195 Chrystie St. New York City

1933 "APRIL FOOL" TUBE Now a Reality!

They laughed when RADIO-CRAFT ran a "construction" article on its tiny "WestingMouse" radio set and tubes! Now the tubes are an actuality!! Only slightly larger in diameter than a lead pencil, nevertheless only 3 of these are required in an audio amplifier to make a hearing-aid. Just as the "peanut"-type tubes made possible the "Personal" Radio Sets now on the market, so too these newer and smaller tubes bid fair to open up yet another field of activity—the manufacture of "Vestpocket" Radio Sets! Read the technical details of these new tubes—then try your hand at building a small-space radio set and win the award described elsewhere in this article.

R. D. WASHBURNE

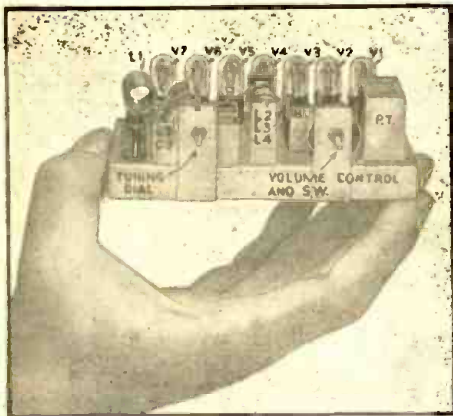

"A Revolutionary Radio Development—the Vest-pocket 7-Tube Superhetero-Ultradyne, by Ulysses Fips, Staff Reporter," read the title and byline of an article in the May, 1933, issue of Radio-Craft describing the "design" and "construction" of the matchbox-size radio receiver illustrated above. An April 1st hoax, many readers nevertheless wrote in, asking where they could obtain the pilotlight-size type "APR-1" tubes shown in the photograph! Well, the joke's on us, for here they are, as the heading illustration and the cover "spot" show!!

THE day of wristwatch-size radio sets and hearing-aids is here . . . ! We modify this to say . . . at least as to tubes; it now remains for manufacturers to get busy and produce associated components of equivalent small-space design. Carrying the trade name of "Micro-tube," these new amplifier tubes, illustrated here and on the cover, introduce entirely new techniques in small-space vacuum tubes.

SUPER-TINY

In the first place, they are so diminutive it is difficult to draw a comparison which will do them justice. One comparison is the view, on the cover, of the Microtubes scaled to compare with an ordinary dial-light or pilotlight; another is the sketch which shows the unique construction and actual dimensions of the very rugged Microtube. Their size was once the subject of a famous April Fool's-day joke (see illustration at upper-left); today they hoist the prankster by his own petard!

These tubes so far are available in only 2 standard types (special types to order): M74, screen-grid voltage amplifier; and, M54, tetrode beam-characteristic power amplifier. Applicational A.F. amplifier circuits for both types are here diagrammed. Characteristics data are shown in Table I. Characteristics curves too are given.

The filament "A" drain is 20 ma. for the M74, and 40 ma. for the M54 at 5/8-volt; total (plate and S.-G.) "B" drain is well under 1/2-ma. for the M74 and under 1. ma. for the M54 at about 45 V. The power output of the M54 is ample for most headphone needs.

NEW THEORIES

A construction feature of this tube is that, unlike the conventional beam tube, it incorporates no deflector plates. They are not required in the Microtube for there is no side field from the split plate.

The absence of these deflectors and the plate which would normally surround these

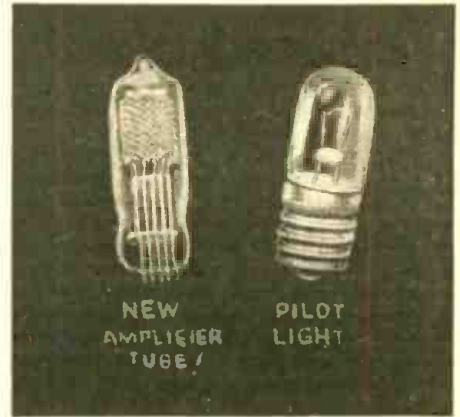

Shown here enlarged, and on the cover in full size, is an illustration of the new Microtubes which are no larger than an ordinary pilotlight. They make possible radio sets and hearing-aids of heretofore unattainably small dimensions.

elements makes possible a much smaller over-all diameter.

The accelerator (screen)-grid and plate are "rather closely spaced," which fact favors a low potential drop in this area. A virtual cathode cannot be observed and theory must be altered somewhat to accommodate itself to this particular tube, the manufacturer states. A metal with unusually low emissive properties (secondary emission) is used for the plate.

It should be noted that these new tubes exhibit beam tube performance with tetrode characteristics. The accelerator-grid is operated at potentials lower than the plate voltage for highest "B" battery efficiency. The plate current - control-grid voltage curve is exceptionally favorable to large control-grid excursions without distortion. An extraordinarily perfect Ep-*I*p curve for a beam tube is obtained.

NON-MICROPHONIC

Still another feature in the construction of this tube is that the plate is held in position by the glass envelope, thus permitting the element support to be entirely from the bottom. One of the first opinions to arise in the minds of technicians is that this construction would seem to tend toward microphonism. The fact of the matter is that Microtubes are inherently free from vibration and microphonics! This is accounted for in part by the construction described above and the fact that the elements are short and rigid; mica is used; and the filament is extremely short and without tension.

PATENTED FILAMENT

This construction of the filament is unique. Regardless of its almost microscopic diameter, the filament will never burn out because of excessive spring tension.

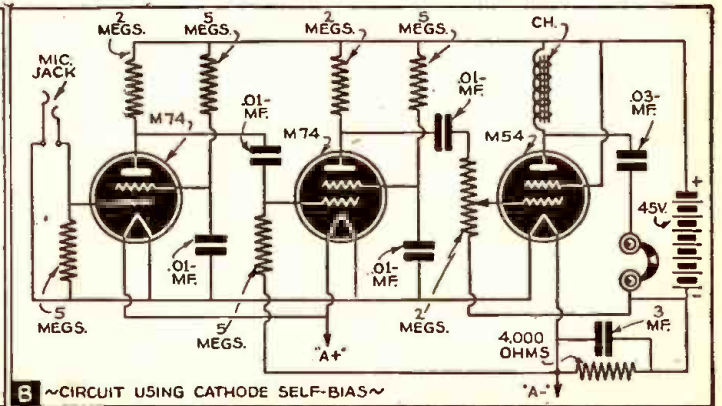
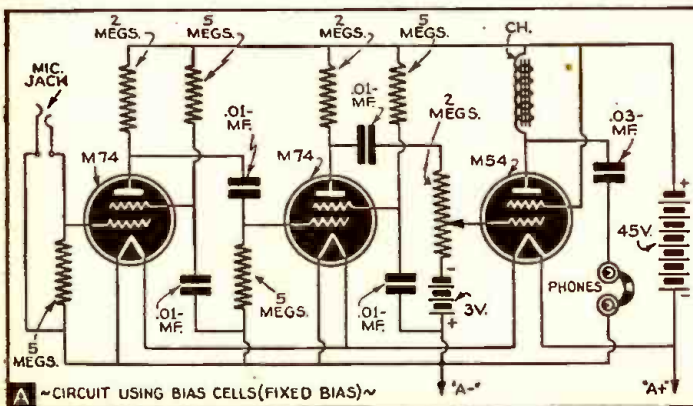

The features of these circuits, recommended for use with the new Microtubes, are described in the accompanying article.

Build for a prize!

RADIO-CRAFT will give a 5-year subscription as an award, to the first constructor who submits an illustrated article, acceptable to the Editors, on how to make a tiny radio set, incorporating from 1 to 5 of these pilllight-size tubes or their equivalent. Manuscripts must be postmarked not later than April 14, 1941. (Any subsequent manuscripts, on this subject, which may be considered suitable for publication will be paid-for at space rates.)

*This award is in addition to payment for the winning article at the usual space rates.

In fact, accelerated laboratory life tests indicate a life expectancy in excess of 7,000 hours!

A contributing factor in this long life is a filament construction feature on which patents have been allowed. Namely, *tapered thickness of the emitter*. In fact, for extreme emissive life in such a short filament, it has been found that a tapered thickness of emitter is essential. Uniform burning temperature is then possible with a minimum of thermal end losses. The heat, in other words, is effective at an optimum portion of the filament length. Maximum values of transconductance as well as emission life are thereby obtained.

This design of the filament makes it possible to apply even the full 1.4 V. to the filament of a single Microtube without causing filament burnout.

UNIFORMITY

Technicians interested in applying these new tubes naturally will be concerned with their reproductivity, in present and subsequent types, with uniform characteristics. This brings up the question of whether automatic equipment is used to turn out Microtubes.

The answer is that at present, automatic equipment is used sparingly and only where it can be used to advantage. Due to their diminutive proportions, much handwork is essential in the assembly of these tubes and in fact, a good portion of it is conducted under microscopes.

The question of uniform characteristics at the present time is a concern mainly of hearing-aid manufacturers, and for these, matched kits of 3 tubes are available.

Microtubes are not yet supplied with plug-in bases. Since a primary purpose in the design of these tubes was to produce a component having minimum dimensions, a maximum saving of space was effected through the use of connecting leads. They are long, tinned, and tempered to stand a maximum amount of bending while being wired into a chassis.

USE AT R.F.

Laboratory technicians will be interested to know that the interelectrode capacities of the Microtubes are satisfactory for ordinary A.F. and broadcast R.F. requirements. For operation at ultra-high frequencies, a modification in the normal tube structure may be indicated, and tubes of this construction are obtainable.

Mention was made above of the absence of mica for insulation. Note in this connection that mica is not only undesirable for rapid tube assembly but it also may be undesirable from an electrical standpoint. Where resistors of 5 or 10 megohms are used in external circuits, for example, mica spacers are a potential source of noise caused by leakage. Incidentally, the highest grade of imported electrical mica is becoming increasingly difficult to obtain.

The absence of mica makes possible the use of a compound of barium-magnesium-aluminum as a getter. The metallic properties of this compound ordinarily prevent it

being used, inasmuch as its deposit on mica insulation would cause shorts or leakage. However it is superior to the commonly-used, non-metallic phosphorus because the latter does not have as complete an affinity for residual gases.

CIRCUIT DATA

The usual circuit arrangement incorporates 2 of the voltage amplifier tubes and a single power tube. Since the filament drain of the type M74 tube is 20 ma. and the type M54 tube draws 40 ma., a series-parallel arrangement of the filaments is employed in which the type M74 tubes are connected in parallel and this combination is placed in series with the filament of the M54. This affords a drop of 5/8-volt across the M74s and 5/8-volt across the M54. Operation from a 1.4-volt cell, without rheostat control, is thus possible.

The total filament drain of about 40 ma. results in a life of approximately 40 hours from the smaller hearing-aid type of drycell.

The total plate drain of the above-mentioned 3-tube combination is less than 1 ma. at a plate potential of 45 volts.

An overall voltage gain of nearly 10,000 is obtainable with this combination, the gain of the M74 being about 25 and of the M54 about 15.

Where greater gain is required—as in portable radio sets or transceivers, noise-level indicators, etc.—4 tubes may be used. In this arrangement, a type M54A power tube is recommended as it has a 20-ma. filament which permits the set of 4 tubes to be connected in series-parallel for uniform "A" drain of 40 ma. The plate current of the type M74A power tube should not be permitted to exceed 0.75-ma.

ILLUSTRATIONS

The curves in Fig. 1 show the plate and screen-grid currents of these tubes with the plate and screen- or accelerator-grid voltages held constant.

Curves showing the screen-grid and plate currents of these tubes plotted against fixed screen-grid voltage and various plate voltages are available from the manufacturer (Microtube Laboratories, Inc.). Also obtainable are plate current vs. plate voltage curves showing the results of varying the screen-grid voltage.

Interesting to design engineers are factory curves (not reproduced here) showing the effect on the total space current of varying the control-grid voltage with 0 or 45 V. on the plates (and with several values of screen-grid voltage). Curves for the M74 voltage amplifier tube compare favorably with those of the ordinary screen-grid tube. In the case of the M54 power amplifier, a small degree of triode characteristic is noted; this is due to the close electrode spacing and comparative coarseness of the grids.

The filament voltage - plate current curves of Fig. 2 show that, in the case of the type M74, where resistance coupling is used ample emission is obtained at an "A" voltage of only 0.5-V. Equivalent curves for the M54, showing the decay in emission with constant plate and S.-G. voltages and falling filament voltage, illustrate that a compromise in filament temperature must be made so that maximum tube life can be had without rheostat control. Full "A" voltage gives an overheated filament while the tubes should have sufficient emission to be useful down to the end point of the "A" cell. Maximum battery hours favor a tube with bright filament; on the other hand, for maximum tube life a low-temperature emitter is desirable.

Schematic diagram A illustrates the use of a crystal microphone and crystal ear-

AC and DC VOLT-OHM-MILLIAMMETER MODEL 666



Pocket Size: 3 1/16" x 5 7/8" x 2 1/8"

\$14.00 Dealer Net Price

This Pocket Size Volt-Ohm-Milliammeter is a complete instrument for all AC-DC Voltage, current and resistance analyses. Has 3" Square Triplet improved rectifier type instrument. AC-DC Voltage scales read: 0-10-50-250-500-1000 at 1000 ohms per volt. DC Milli-ampere scales read: 0-1-10-50-250. Ohms scales read: Low 1/2-300; High 250,000. Resistance range can be increased by adding external batteries. Low loss selector switch. Black molded case and panel . . . completely insulated. RED • DOT Lifetime Guaranteed Measuring Instrument. Alligator Clips, Battery and Test Leads included . . . Dealer Net Price . . . \$14.00.

Model 666-H . . . same as Model 666 but with AC-DC Voltage ranges to 5000 volts (self-contained) . . . \$14.50 Dealer Net Price.

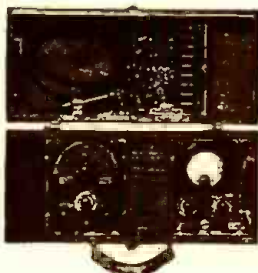

Model 1181-C

This Portable Laboratory includes a 16-range Volt-Ohm-Milliammeter, Battery Operated Signal Generator with direct reading dial, and a complete Free Point Tester . . . Dealer Net Price . . . \$44.84.

WRITE FOR CATALOG—Section 164 Harmon Avenue

TRIPLET ELECTRICAL INSTRUMENT CO.
Bluffton, Ohio



FAR SEEING Atlas engineers started a new chapter in machine tool history when the first Atlas Lathe was introduced. It was the first practical low-cost precision metal lathe. It was the first time the fine new tough metal alloys were used for lathe parts, the first time precision production methods were used in lathe manufacture.



TODAY Atlas Lathes, Shapers, Milling Machines, and Drill Presses are rapidly

changing production ideas in many plants. Modern production engineers have discovered that Atlas Equipment can be used for machining countless small parts that formerly tied up larger expensive machines. And as Atlas Machine Tools are constantly improved to handle new industrial operations, their exceptional values continue to increase for men who select these tools of industry for commercial shop work.

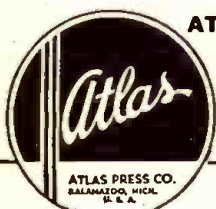

ATLAS PRESS CO.
445 N. Pitcher St.
KALAMAZOO MICH.

LATHES
DRILL PRESSES
ARBOR PRESSES • SHAPERS
MILLING MACHINES



Amazing New "WALSCO" STAPLE DRIVER

for radio men, electricians, or anyone doing stapling. Makes wire and cable installations twice as easy—much neater—saves half the time. Wires can be stapled in corners, behind pipes, into moldings—places never accessible with a hammer and ordinary staples. Drives staples even into walls, brick, mortar, etc. Magazine works automatically and holds strips of staples which come in several colors. Ask your jobber for demonstration and catalogue 41-R of all WALSCO PRODUCTS.

or write **WALTER L. SCHOTT CO.**
5264 W. Pico Boulevard, Los Angeles, California

SOLAR RED-CAPS
Smaller Diameter Dry Electrolytics

SPEED Servicing

Write for Catalog

SOLAR MFG. CORP. Bayonne, New Jersey

phone in a circuit employing fixed-bias. Dry-disc bias cells are utilized together with maximum filament drop for the power tube bias. If the driving signal is strong it may be necessary to apply additional bias to the 2nd-stage voltage amplifier tube. This can be taken from one of the "C"-bias cells in the power tube control-grid circuit.

Circuit B, employing self-bias, features small size, light weight, and lowered "B" drain. Proper bias at all "B" battery voltages is obtained, but the power output is slightly lower than with the circuit shown at A. The bias on the 2nd-stage voltage amplifier tube is suitable for considerable swing of the control-grid voltage.

In both these circuits the headphone or earphone is fed through a coupling condenser. This eliminates the bulk and weight of an output transformer.

For those who are slow to comprehend the significance of some of the developments rapidly taking place in the radio field, we point out that the present run of so-called "miniature" tubes opened up the market of "Personal Portables," millions of which will be sold in the next year or two. This, without appreciably affecting the sale of the larger or "standard" radio and phono-radio receivers. (The tube-type hearing-aids

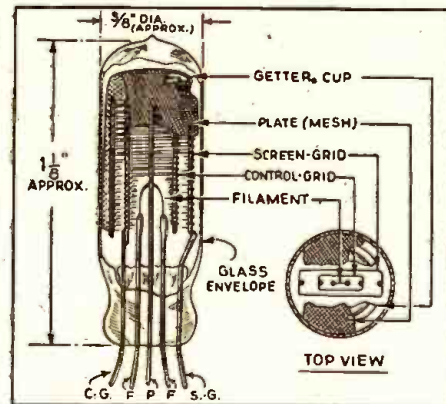

"We went to work on one of the new super-tiny Microtubes, and here you see what we saw, dimensions and all. Watchmakers would feel at home putting one of these together."

which may be concealed on the person also were developed around tubes in the "minia-

TABLE I—(CHARACTERISTICS)

Type	Voltage & Current							Plate Impedance	Transconductance	Amp. factor (mu)	Load resis. (ohms)	Output (milli-w.)
	Ef	If	Ep	Ec	Esg	Isk	Ip					
M74 Amplifier	5/8	0.02	45	0	22 1/2	0.07	0.34	0.5-meg.	125 mmhos.	63 (mu)	—	—
M64 Power Amplifier	5/8	0.04	45	4	45	0.1	0.8	0.13-meg.	200 mmhos.	26 (mu)	35,000	5

SERVICEMEN'S DEADLINE — March 29 at 3:00 A.M.

(Continued from page 603)

pairs, etc., can be suggested(*). Later, other service work may be necessary as a result of the frequency shuffle.

It isn't possible to uproot an extensive interlocking system such as Radio Broadcasting without some complications resulting. Therefore, the broadcast listener must look to YOU, Mr. Radio Serviceman, for adjustment of his radio receiver to meet the changing conditions.

Present frequency allocations are based partly on experience extending over a period of 20 years. In this time, there has been a great increase in (a) the number of stations, (b) their power, and (c) the length of time they are on the air. These factors have always existed as potential obstacles to interference-free reception.

Station operation under these handicaps has been made possible only through the use of various artifices as for example, (a) directional antenna systems, (b) daylight/

(*) See "Rebuilding for Profit," Radio-Craft, Aug. 1940.

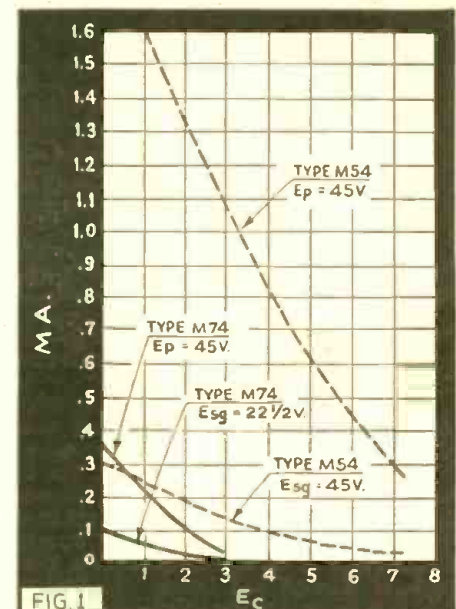

FIG. 1

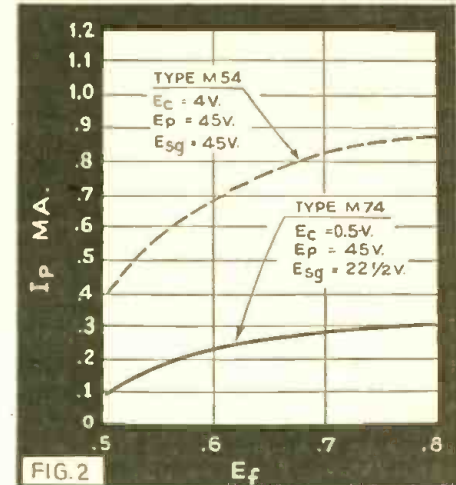

FIG. 2

ture" class.) Therefore the writer predicts that the newer, "super-tiny" tubes, here described, will almost certainly crack open yet another tremendous market, viz.: VEST-POCKET PORTABLES.

nighttime power output ratios, and (c) the sharing of time.

Hence, the usual "borderline" trouble-makers—cross-modulation, image-frequency distortion and sideband-cutting—will be the most objectionable reception characteristics during the transitional period subsequent to March 29, and the Serviceman must be prepared to capitalize accordingly.

For example, complaints of insensitivity (first noticed when desired stations, the frequencies of which have been changed, are found to come in poorly at positions on the dial not ordinarily used), and cross-modulation, probably indicate the need for realigning R.F. and (in superhets.) oscillator circuits. Whistles and distortion usually can be cleared-up by realigning the I.F. circuits (**).

Plan now to handle this service business!

(**) See "Ham Interference on Broadcast Band," Radio-Craft, Jan., '41; and "So You Have Interference?" Serv., '40. Also see the series: "Servicing R.F. Coils," June, '40; "Realigning I.F. Coils," July, '40; and "Replacing I.F. Coils," Aug., '40.

An Englishman's Home-Built TELEVISION BLACK-SPOTTER

The following article describes a television device as built by an English technician. Necessarily, therefore, the British tubes which were used have been described. For this reason, technicians who may wish to substitute American tubes may find it necessary to slightly alter the characteristics of associated components as determined experimentally; however, the characteristics (of the British tubes) have been supplied for comparison. We have retained the English technical terms used by the author—and familiar to most readers of Radio-Craft—but American equivalents, in italics, immediately follow (in parenthesis) the first use of each word.

M. E. SOUTHALL



General view of the completed Black-Spotter.

WHEN aerial alterations cannot reduce static effects a *black-spotter* will allow the interference to be more easily tolerated by changing the bright flashes into dark areas, which are far less troublesome as they do not show up so much against a normal picture which contains a greater proportion of dark tones to high lights.

What the black-spotter does is to reverse the phase of the interfering voltages being applied to the cathode-ray tube and because of this characteristic they are often termed—at least, in England—Interference Phase Reversers. In this article we will deal with constructional details and practical application to television receivers.

MODULATING THE C.-R. TUBE BEAM

There are 2 methods of modulating the beam in the C.-R. tube to produce the tone variations which go to make up an image: (1) grid modulation, and (2) cathode modulation.

The former method was used in the T.R.F. (tuned-radio-frequency) receivers but because of the number of essential stages through which the signal had to pass, an extra stage had to be used in order to bring about a positive "picture." In other words, if the voltages developed across the anode (plate) load of the last essential stage is applied to the grid of the C.-R. tube the image will appear similar to a photographic negative. To correct this, the phase of the voltages must be reversed and this may be accomplished by passing the signals through an extra stage.

With the advent of the superheterodyne

type of circuit for television reception and the need for reducing costs so as to bring down the prices of television receivers to a man-in-the-street level the extra stage was eliminated and the signals made to modulate the cathode which has the opposite effect to modulating the grid. The required phase reversal is thus brought about automatically.

Because of these 2 methods of modulating the beam in the C.-R. tube, 2 types of black-spotters were necessary to deal with the receivers on the English market and they will be described separately.

We will take first the black-spotter for use with grid-modulated C.-R. tubes.

GRID-MODULATION 'SPOTTER

It may help readers if we trace the circuit (Fig. 1) through. The image signals are conveyed to the grid of the valve (tube) from the receiver chassis by the green lead. Let us assume that the valve is not working; then the signals will proceed through R1 to the grid of the C.-R. tube. The condenser C1 and resistance R2 and the H.-T. (high-tension or high-voltage) circuits in the receiver, to which the red lead is connected, offer too high an impedance to cause the signal to stray in their direction.

Units R3, R4 and VR1 provide means of biasing the valve and by adjusting VR1 a cut-off voltage may be applied to the valve so that it is inoperative and the condition above prevails.

Now let us adjust VR1 until the valve is operative. The image signals on the grid will then affect the anode current and develop voltages across R2 which are fed through C1 into the grid of the C.-R. tube. These voltages will be in opposition to the existing voltages across R1 and will, if great enough as determined by the adjustment of VR1, cancel them and cause a reverse voltage to be applied to the grid of the C.-R. tube. The image will then be negative.

The correct working condition, of course, is when VR1 is so adjusted that the valve is just cut off from operating, i.e., the average image signal voltage on the grid is just below the bias voltage of the cathode. Then, when a sudden rise in voltage due to a flash of static is applied to the grid, the valve operates and a reverse voltage is applied to the grid of the C.-R. tube, which goes darker instead of brighter under the influence of the static.

The valve used in this black-spotter unit is an MH41 and readers may find the following details of it useful for comparing it with American equivalents. It must be appreciated that the earlier grid-modulated television receivers with which it was designed to operate employed 4-V. valves and not the 6.3-V. type now used.

Characteristics (MH41)

Heater volts	4.0 V.
Heater current	1.0 A.
Anode volts	200 V. (max.)
*Amplification factor	80
*Impedance	13,300 ohms
*Mutual conductance	6.0 ma./V.

*At Ea 100. Eg 0.

Interelectrode capacities

G-E	8.1 mmf.
G-A	4.3 mmf.
A-E	4.3 mmf.

CONSTRUCTION

As will be seen from the accompanying photograph and sketches, the device is made up on a rectangular piece of mild steel, preferably cadmium-plated. The over-all dimensions are, 4½ x 3¼ ins. wide, of which 1¼ ins. are bent over at right-angles for strengthening and this forms a fixing bracket (*Mounting*).

Approximately across the middle of the underneath of the deck is mounted, by means of the angle brackets, a paxolin (an insulating material) terminal strip 2½ ins. long x ½-in. wide carrying 3 soldering tags (*lugs*) and 1 terminal. In the deck a 1¼-in. hole is cut to allow for the mounting of a valve holder. Of course, this hole may be of a slightly different dimension to accommodate the type of valve-holder (*tube socket*) it is proposed to use. Matching up this hole towards the other end of the deck is a ¼-in. hole to take the one-hole fixing (*mounting*) arrangement of a variable resistance.

All components are mounted directly between the various soldering tags and no difficulty should be experienced in assembling the unit after studying the accompanying illustrations, which clearly show the disposition of the various parts. One point which may not be quite clear is that there must be a connection comprising a short length of wire between the end soldering tag to which the black lead is attached and the terminal work (*chassis ground*) of the unit.

This is conveniently accomplished by means of a short length of wire soldered to the tag and to the adjacent rivet or nut and bolt by which the paxolin tag strip is held to the angle bracket.

As this particular type of black-spotter is for use with grid-modulated C.-R. tubes, and as it is in effect a phase reverser, it has to be connected in series with the grid of the C.-R. tube. The connection to any particular television receiver will, naturally, depend upon the layout of the receiver but general fitting (*assembly*) instructions would be as follows:

(1) Screw the unit on to the floor or side of the cabinet in a position which will give the shortest possible run of wiring

Order your copy NOW—the only

P. A. HANDBOOK



ONLY
25
CENTS
A COPY

**MOST COMPLETE
AND AUTHENTIC
P. A. BOOK PUBLISHED**

THAT no book has yet been published which covers amplifiers and sound systems (also kindred systems) in one complete, authentic volume is almost unbelievable. Yet, it is a fact, there is no book in print which covers Public Address from A to Z. To bridge this wide-spread gap, RAD-CRAFT will publish a complete, magnificent volume on Public Address of such magnitude—so complete and authoritative—that every man engaged in radio can have both a theoretical and practical knowledge of the function and operation of sound systems. The editorial pages are so filled with instruction and replete with illustrations that the volume fully justifies its title. The 1940 AMPLIFIER HANDBOOK AND PUBLIC ADDRESS GUIDE. This Great HANDBOOK on Public Address should be read and studied by those who consistently build, service and sell sound equipment.

A MATCHLESS VOLUME

As complete as you would expect to find any engineering handbook—this is how the radio or P. A. man finds the AMPLIFIER HANDBOOK AND PUBLIC ADDRESS GUIDE. With essential technical data compiled from an exceptionally large number of sources, the volume covers nearly a hundred different subjects coordinating every conceivable branch or sub-division of Public Address.

THE CONTENTS

To actually show the scope and magnitude of the AMPLIFIER HANDBOOK AND PUBLIC ADDRESS GUIDE, an analysis of the contents is found at the right, showing the breakdown of the material featured within each particular section. A thorough reading of the contents shows the completeness of this book.

RAD-CRAFT PUBLICATIONS ■ 20 VESEY STREET ■ NEW YORK, N. Y.

RAD-CRAFT PUBLICATIONS, INC. ★ 20 VESEY STREET ★ NEW YORK, N. Y. RC.441
Gentlemen: Enclosed find my remittance of 25c for which send me POSTPAID, one copy of your NEW—1940 AMPLIFIER HANDBOOK AND PUBLIC ADDRESS GUIDE.

Send me others, for friends, also POSTPAID @ 25c each.

Name Address

City State

Remit by check or money order; register letter if you send cash or unused U.S. Postage Stamps.

A Resume of the Contents of the AMPLIFIER HANDBOOK AND PUBLIC ADDRESS GUIDE

FOREWORD

INTRODUCTION

Definitions—decibels, frequency, input, output, impedance, etc.

SECTION I—SOURCE

Carbon microphones (single-button and double-button)
Condenser microphones
Velocity (ribbon) microphones
Dynamic microphones
Crystal microphones (sound-cell types, crystal diaphragm types)
Cardioid microphones
Contact microphones
Phonograph pickups (magnetic types, crystal types)

SECTION II—AMPLIFIERS

Voltage Amplification

Design of resistance-coupled voltage amplifiers
Commercial voltage amplifier
The Power Stage
Class A amplifiers
Class AB amplifiers
Class AB₁ amplifiers
Class AB₂ amplifiers
Class B amplifiers
When to apply class A, AB, and B amplification

Power Supplies

Half-wave rectification
Full-wave rectification
Voltage doublers

Filter Circuits

Power supply regulation, etc.

Practical Hints on Amplifier Construction

Microphonism
Placement of components
Tone compensation
Inverse feedback
Remote control methods

SECTION III—DISTRIBUTION

The Loudspeaker

Dynamic speakers
Speaker performance (frequency response, efficiency)
High-fidelity speakers
Speaker Baffles and Housings
Outdoor speaker installations
Power cone speakers
Radial (360° distribution) speaker baffles

SECTION IV—COORDINATION

Input impedance matching
Matching speakers to P.A. installations

Phasing speakers

Effect of mismatching speakers to amplifier output

A typical P.A. installation (in a skating rink)

SECTION V—USEFUL PUBLIC ADDRESS DATA AND INFORMATION

Speaker matching technique
The ABC of Db., VU, Mu, Gm and Sm
Charts and formulas useful to the practical P.A. sound man
Handy index to important articles on public address and sound

Order Your Copy NOW—

*Clip Coupon and
Mail Today!*

between the chassis of the receiver and the grid terminal of the C.-R. tube holder.

(2) Connect the brown lead of the unit to the heater tag of the nearest valve holder or to any convenient supply points, such as the heater tags on the mains (power) transformer itself.

(3) Join the flexible red lead of the unit to the point on the television chassis which is giving H.T. positive of about 300 V.

(4) Disconnect the lead going from the television receiver chassis to the grid terminal on the C.-R. tube holder and re-connect this lead to the one and only terminal marked (G) on the terminal strip of the black-spotter unit. Then join the green lead of the black-spotter to the terminal on the C.-R. tube holder from which the grid lead has just been disconnected.

(5) Earth (ground) the black-spotter unit by connecting an earth wire from under one of the fixing screws on the unit to the earth tag or any convenient bolt on the television receiver chassis.

(6) Switch-on the instrument and test the results by adjusting the variable resistance on the black-spotter unit. The correct setting for the control is that which just blacks-out the effect of the electrical interference experienced. If the control is adjusted to maximum the whole image will appear negative, that is, the black appear white, and vice versa.

CATHODE-MODULATION 'SPOTTER

For television receivers whose C.-R. tubes are cathode modulated a different arrangement of black-spotter is necessary, as stated earlier in this article.

A black-spotter for this type of circuit is shown in Fig. 2. Its layout is very similar to the black-spotter already described so it is only necessary to go over the circuit arrangements.

At A in Fig. 3 is shown the cathode and grid arrangements of a cathode-modulated C.-R. tube. It will be seen that the picture pulses develop a voltage across the cathode resistance, thus biasing the cathode with regard to the grid which is connected to chassis.

At B the black-spotter is shown connected to the C.-R. tube. It will be seen that the grid of the tube now has R1 between it and chassis while the cathode of the black-spotter valve is directly joined to the cathode of the C.-R. tube. Because of this latter connection the cathode of the black-spotter is modulated by the image signals and an amplified version of the voltages would appear across the anode resistor R2.

These voltages would be applied through C1 to R1 which would impress the voltages on to the grid of the C.-R. tube so that the cathode and grid would swing together so that no potential difference would exist between them and no variation of the spot brilliance would occur. If the voltages on the grid were greater than those on the cathode then the "picture" would become negative. (Pictorially, not electrically.)

As in the previous black-spotter, however, the valve can be biased to a cut-off point so that it is inoperative by adjusting VR1 and this is done so that no effect upon the image is noticed during normal conditions but directly a big pulse of static comes along, the valve operates from the excessive voltage on the cathode and a reversed voltage is impressed upon the grid of the tube, thus turning the bright flash of the static into a dark area.

CONSTRUCTION

Constructional details are practically identical with those of the previous unit. The components are actually less in number and are easily accommodated on the same

Fig. 3—How the Black-Spotter for cathode-modulated C.-R. tubes operates.

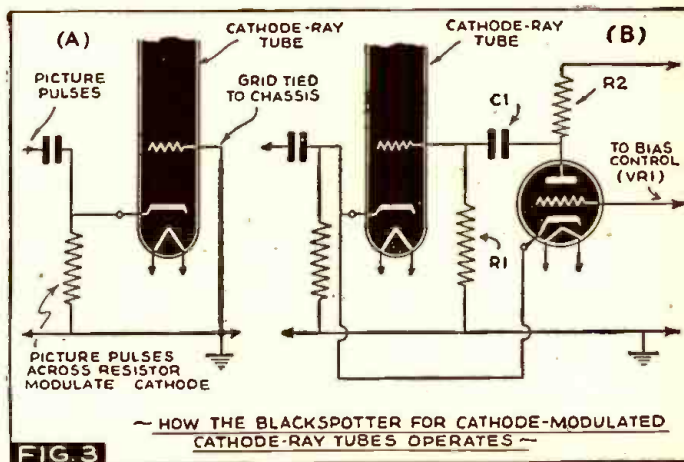

type of L-shaped terminal bracket. The leads are similar to those previously described and the circuit diagram clearly indicates where they are to be connected in the television receiver and to the C.-R. tube base. It will be observed that the terminal marked X on the diagram of the C.-R. tube base is not normally employed in our English television receivers and it therefore forms a very useful and convenient anchorage for the resistance R1.

As will be seen from the diagram of connections the lead from the television receiver to the grid terminal of the C.-R. tube base is disconnected and re-connected to the spare terminal of the tube being employed. If there is not a spare terminal a suitable anchorage must be provided or the resistance R1 protected by systoflex (a low-loss tubing insulation) sleeving to strengthen it so that it becomes part of the grid lead. The green lead of the black-spotter is then connected to the grid terminal of the C.-R. tube base and the other connections made as indicated on the diagram.

The installation of the unit into the television receiver cabinet is precisely as for the previous black-spotter just described and the variable control is adjusted to give the most pleasing results.

An English type Z62 valve is used in this black-spotter but is connected to operate as a triode. Its normal pentode characteristics are given elsewhere in this article but as a triode the following data may be helpful to readers finding a suitable substitute.

Characteristics (Z62)

- Anode volts300 V.
- Anode dissipation2.0 W
- *Mutual conductance8.5 MA./V.
- *Amplification factor38
- *Impedance4,460 ohms

*At Ea = 150 V. Eg = -2 V.

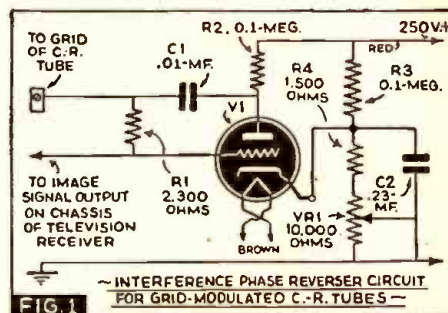

FIG. 1

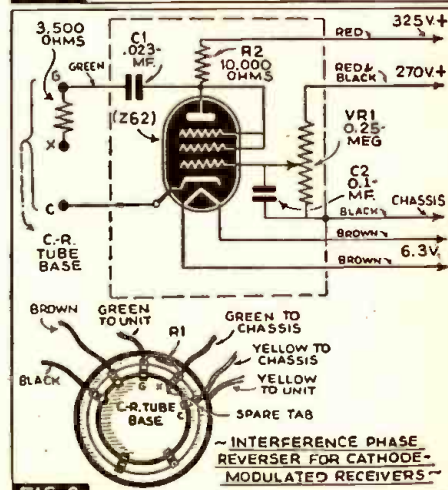

FIG. 2

Diagrammed here are the 2 basic types of Black-Spotter; the manner in which either type functions is shown in Fig. 3. In Fig. 1, tube V1 is the English Marconi type MH41 described in the text. Television experimenters will have little difficulty applying to American-type C.-R. tubes the useful circuits shown here as developed with English types. The completed device makes for better enjoyment of television programs by reducing to a negligible quantity the annoying flecks of light due to static impulses of various kinds.

"THE PEN IS MIGHTIER THAN THE . . . BOMBS!"

This article was written 'Midst Bursting Bombs' writes the author:

I am sorry I have been so long over the article but we have been so busy one way and another that there hardly seems enough time to even sleep. Just as I am dictating these very words the sirens are wailing out their warning, but we are luckier tonight than most nights as it is just 9 o'clock and this has given us quite a pleasant uninterrupted evening! However, just lately we have had a re-arrangement for working out our evening and night duties in my local A.R.P. division which gives us a few more consecutive evenings off duty and I am thus able to get down to writing again.

We are getting quite hardened or, perhaps, careless over these air raids as I have written pages of this article with the night bombers right overhead, zooming about backward and forward in search of certain objectives in my neighborhood, but apart from making me keep both ears tuned-in for the now familiar whistling sound of falling bombs, I don't give Hitler another thought. After all, you know, we can't allow that man to interfere with our lives too much!

In conclusion I would like to say how much of an achievement I consider it to have an article published in a Hugo Gernsback publication. I have many back numbers of "SCIENCE AND INVENTION" dating back to 1920. I was only in my 'teens when I bought those inspiring magazines which interested me immensely due to my imaginative nature and I still enjoy studying the very fine artistic covers, especially those depicting the Ferris Wheel, the Overhead Single-Rail Railway, and many others. I little thought in those days, that an article from my pen would appear in one of H. G.'s publications.

M. E. SOUTHALL.
Somewhere in England.

How to Make a Reliable

MARINE RADIO DIRECTION FINDER

Described here is a Radio Direction Finder that incorporates circuit features especially desirable in an instrument designed particularly for Marine use. These features include a crystal-controlled I.F. stage, preamplifier stage, visual null indicator, and noise limiter. Essential details for constructing the weatherproof loop antenna are given.

J. M. BINDING

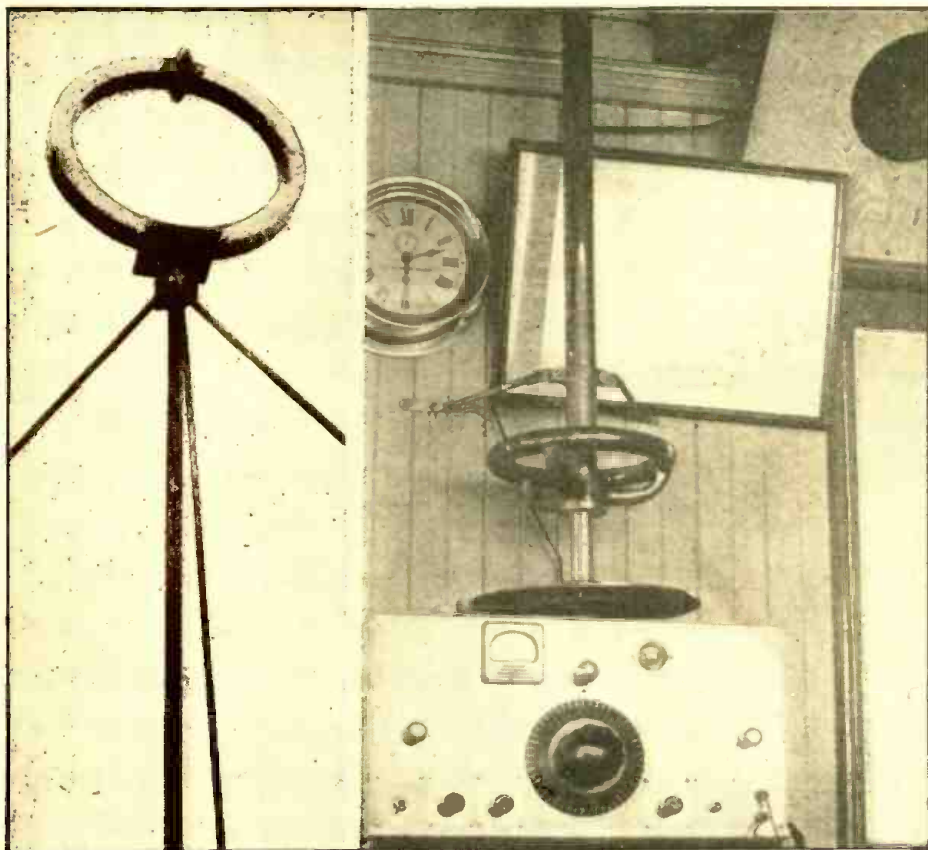

The completed Marine Radio Direction Finder in use. The weatherproof loop antenna shown at left extends through the roof of the chart house; its directivity is controlled at the radio receiver, as shown in the photo at right. The loudspeaker is shown at upper-right. "This instrument had a full season of use on a freighter plying the Great Lakes and has proven extremely accurate and sensitive," says Mr. Binding, whose hobby is building Radio Direction Finders.

MANY articles have been published on combination direction finders and all-wave radio sets, but a radio receiver properly designed for reliable direction finding does not lend itself to all-wave use.

Due to the narrow band-width (2 kc.), low power, and high noise level in the beacon band, the R.F. and I.F. sections must be designed for maximum sensitivity and selectivity and the audio section should have a response peak in the vicinity of 1,000 cycles with a rather sharp attenuation about 200 cycles either side of this peak.

CIRCUIT

The schematic diagram shows a basic Marine Direction Finder which can and has been altered by eliminations and in one case by an addition to meet almost any direction finding need.

A 6C5 tube can be added as a D.C. amplifier to provide greater "eye" indication on weak signals. This is done by connecting the grid of the 6C5 tube to the junction of the 0.5-meg. resistor and 0.05-mf. condenser,

and connecting the grid of the eye tube to the cathode of the 6C5 tube. The bias resistor in the cathode circuit of the 6C5 tube in this case should be made variable so that the eye indication can be controlled.

A simple Direction Finder can be made by eliminating the R.F. stage, crystal I.F. stage, B.F.O., Visual Null Indicator, and Noise Limiter. One of these models has been in successful operation for several years on the Great Lakes and it might be stated in passing that for Great Lakes operation the B.F.O. serves no particular purpose. The most important additions to this simple model in the order of their importance are the Crystal I.F. stage and the R.F. stage. The Crystal I.F. stage allows the taking of bearings under extremely adverse noise conditions and the R.F. stage adds to the sensitivity. The Visual Null Indicator is a matter of personal preference; and the Noise Limiter *does* level-out the noise peaks which have the unhappy faculty of blanking-out hearing for an instant.

Now for the actual construction, starting with the input.

CONSTRUCTION

The antenna coil is made by removing the regular primary and adding the 2 primaries, one on either side of the secondary, after cutting off dowels to properly space coils. Here make sure that all windings are in the same direction. The balance of the circuit is more or less conventional and should need no further comment. If speaker operation is desired it can be plugged-in in place of phones. Here a good magnetic speaker due to its limited frequency response is better than a permanent-magnet type.

While the schematic diagram and List of Parts show a National PW4 tuning condenser (C1) this is not entirely essential as the loop circuit does not track. Attempts to make this circuit track by the use of a higher-inductance loop or the addition of loading coils in the circuit cause a decrease in sensitivity and broadening of the null point. This is of no importance as the circuit, when resonated at 300 kc. is broadly resonant enough to cover the narrow beacon band (286 kc. to 314 kc.) without appreciable loss at either end of the band; obviously the section of condenser C1 in this circuit can be eliminated by substituting a 200 mmf. fixed mica condenser in parallel with condenser C2, thus allowing the use of any good 3-gang condenser with no necessity for isolated stators. For maximum results, however, condenser C1 should be retained as shown.

Condenser C2 must, of course, be insulated from chassis and be mounted far enough back of panel to allow use of insulated shaft coupling to couple condenser C2 shaft to shaft protruding through panel bushing to knob. This will insulate condenser C2 shaft from panel and prevent antenna effect which would be caused if condenser C2 shaft extended directly through panel.

Condenser C2 should be mounted directly above B.F.O. coil (L7) or better yet can be mounted in place of this coil using panel opening intended for B.F.O. pitch control if B.F.O. is eliminated, as it may well be for all ordinary conditions.

The I.F. section is very hot, and should be carefully wired, and all grid and diode leads in I.F., N.L. and 1st audio circuits should be carefully shielded. In the set shown the I.F. circuit breaks into oscillation with the last few degrees rotation of sensitivity control R1. This is not objectionable as for all normal use volume is controlled by the use of this control, R1; and audio control R3 is only used when sensitivity control R1 will not give enough reduction in volume, which will happen only when taking a bearing on-beacon within a few miles in thick or foggy weather. Controlling volume in this manner gives the greatest possible signal-to-noise ratio.

The audio circuit is conventional, except as to size of coupling condensers and resistances, and is also filtered.

EXPERIMENTERS

EVERYTHING IN RADIO



BA
HAS IT?

This big book serves your entire needs. It includes sets, parts and supplies, public address, amateur equipment, test sets, kits, fluorescent lighting. Nationally known favorites at lowest possible prices. Write today for your copy of this

BIG FREE CATALOG

BURSTEIN-APPLEBEE COMPANY
1012-14 MCGEE STREET, KANSAS CITY, MISSOURI

FREE!

HAMMARLUND NEW "41" RADIO CATALOG

The latest Hammarlund catalog with complete data, illustrations, drawings and curves on the entire Hammarlund line. Address Department RC-4-1 for your free copy.

HAMMARLUND MFG. CO., INC.
424-438 West 33rd Street, New York City

POWER and LIGHT

ONAN A.C. ELECTRIC PLANTS supply current for Radios, Transmitters and Receivers, P. A. Systems, Movie Projectors, Sound Trucks, Airtrains, Tools, Lights, All Appliances. Used as Standby Equipment in Schools, Hospitals, Theatres and Public Buildings in case of Power Line Failure due to Storms, Floods, etc. Available in 110 or 220 Volt A.C.—12, 32 and 110 Volt D.C.—Also Dual Voltage A.C.-D.C. Types. Manual, Full-Automatic & Self-Starting. \$99 and up. Shipped, Ready to Run. O.N.A.N. S.O.S. 5015
720 Royalston Ave., Minneapolis, Minn.



RADIO DIAGRAMS

MOST-OFTEN-NEEDED

ALL MAKES 1926-1938

In this one low-priced manual you have all the circuits you really need. 427 diagrams of most-often serviced radios is the help you want for easier, faster, and better repairs. You will find 4 out of 5 diagrams needed in this manual. 244 pages, large 8½x11 in. size. Special price **\$1.95**

HOW TO SAVE TIME

Service hints, diagrams, alignment data, test charts, and parts lists included will prove time-savers and money-makers for you. Get these handy "on-the-job" handbooks. No need to work blind-folded. The time saved in two days will more than pay for these manuals.

1939-1940 DIAGRAMS

This single manual will give you over 80% of all 1939-40 circuits ever needed, acquaint you with recent radio developments, and teach you how to service quickly millions of sets sold last year. Models of 43 manufacturers. 212 large pages, 8½x11 inches. Limited quantity at **\$1.50**

FREE EXAMINATION

SUPREME PUBLICATIONS, Room 735
3727 W. 13th St., Chicago, Illinois

Ship the manuals checked. I must be satisfied or you will refund my money in full.

Most Often-Needed Diagrams, 1926-1938. @ \$1.95

Most Popular 1940 Radio Diagrams. @ \$1.50

I am enclosing \$....., send postpaid

Send C.O.D. I will pay the mailman.

NAME (Write address below and send this corner).....

LOOP

The loop is wound with 20 turns of Litz loop wire on a form made up of ¾-in. marine plywood (preferably hardwood) and ¾-in. diameter hardwood dowels. The smaller form is used for an inboard loop and the larger form for an outboard loop.

The wire is wound in spiderweb fashion, and after winding, the ends are secured and the loop center-tapped. The whole assembly is now boiled in paraffin to drive off any moisture. This can be done in a narrow pan about 3 or 4 ins. wide and 12 or 14 ins. long, by turning the loop every 4 or 5 minutes while the paraffin is boiling.

The loop is now covered with light copper sheet soldered waterproof except for 2-in. window at top and ¼-in. diameter opening at bottom for leads. The window is wrapped with bias tape set in wing dope and a drip ring made of hardwood added (if the loop is "outboard"), after which several more coats of wing dope are applied. A flange or coupling to accommodate extension pipe is soldered to the bottom of the loop. In running leads through extension pipe low-loss cable should be used to keep capacity as low as possible. A loop of this type is a notoriously poor antenna and all stray capacities should be kept low. The extension pipe should terminate in a 3-way phone plug which plugs into a 3-way jack on top of the set.

Wherever possible the outboard loop should be used raising it as high as convenient above any surrounding metal objects which might cause reflections or distortion and errors.

No "sense" antenna to distinguish between the 2 null points, which are 180° apart, has been included as it serves no real purpose.

HOW TO FIND DIRECTION

In use the pointers should be tightened in place at exactly right-angles (90°) to the plane of the loop and the index should be set so that a line through index mark and the centerline of loop jack J1 exactly parallels the ship's keel and with index mark forward of jack J1.

With the set operating and everything in readiness, a reading should be taken of the ship's compass and any magnetic variation added or subtracted; then the compass card on the Direction Finder should be rotated until this corrected reading coincides with the index mark. A beacon is now tuned-in

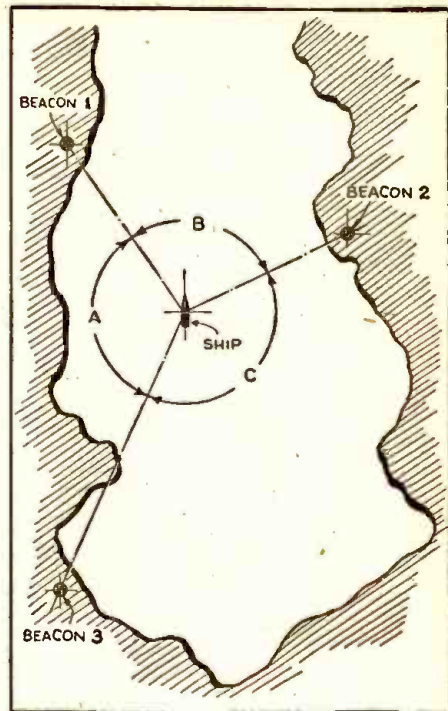
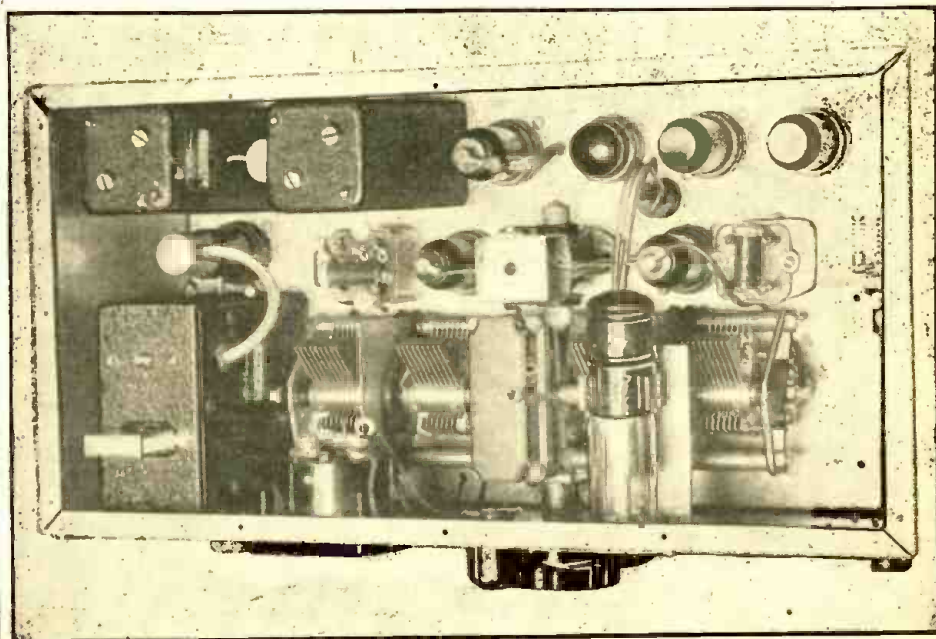

Fig. 1—Plotting a direction by radio. Observed angles A, B, C can be true for only one position of the ship.

and the point of no-signal or "null" point determined by rotating the loop slowly. If the observed null point is several degrees wide take the midpoint. This gives us a "line of position" and it should be readily apparent that the ship lies somewhere on this line.

This line is laid down on the chart and another beacon tuned-in and the operation repeated, giving another line of position, which, when laid down on the chart, will give a "fix" at a point where the 2 lines of position cross. The ship then is at this point. This operation should be repeated on a 3rd beacon giving a 3rd line of position, which, laid down on the chart, should cross the other 2 lines very close to their intersection unless some error exists in readings or ship's compass, thereby giving a check on previous readings.

If the Direction Finder has been checked while the ship is in port where directions can be certain, or with a known compass, it becomes possible then to determine posi-



Inside view showing relation of the major components of the Direction Finder.

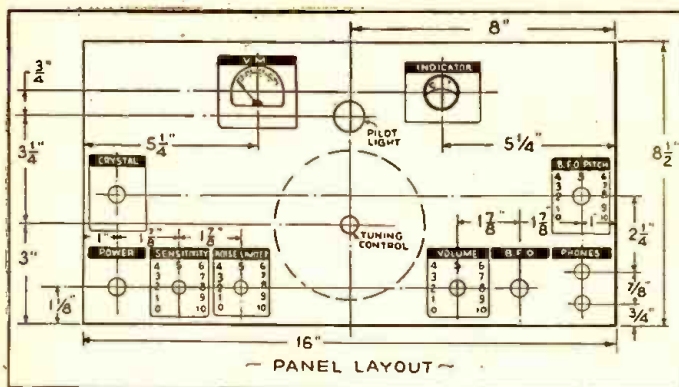

Front panel dimensions and markings of the completed Direction Finder.

tions and directions correctly even when the ship's compass is in error, as in the case of a freighter carrying steel or iron ore which may destroy accuracy of ship's compass by several points. If, after repeating the former readings the error persists where lines of position cross and is greater than could be attributed to error in readings of the Direction Finder, the ship's compass could be in error and it is possible by using observed angles between readings to plot position. (See Fig 1.)

In case the ship is taking a course toward port with a beacon, the loop pointer should be set to the index mark and the ship can be kept on-course by keeping on the null point.

A good many beacons are synchronized with fog signals so that the ending of a long dash coincides with the start of the fog signal, thus by dividing by 5, the elapsed time in seconds from the ending of the long dash until fog signal is heard, the distance in miles from the port is obtained.

With new beacons being added yearly and the operation of direction finders becoming better understood, it is only a matter of time until the radio direction finder will be considered as necessary as a compass on ships large and small.

LIST OF PARTS

CONDENSERS

- One National type PW4, 4-gang, 160 mmf. per section (see text), C1;
- One Meissner type 21-5217 3-gang, 410 mmf., compact variable, C2;
- Two Hammarlund type CTS-160, C3, C4;
- Fourteen tubular, 0.1 mf., 600 V., C5, C6, C7, C8, C10, C11, C12, C13, C14, C15, C16, C17, C18, C31;
- Two mica, fixed, 100 mmf., C9, C21;
- Two tubular, 0.05-mf., 600 V., C19, C32;
- One mica, fixed, 10 mmf., C20;
- One mica, fixed, 50 mmf., C22;
- Four tubular, 0.001-mf., 600 V., C23, C25, C26, C27;
- One mica, fixed, 200 mmf., C24;
- Two tubular, 0.25-mf., 600 V., C28, C29;
- One tubular, 0.005-mf., 600 V., C30;
- One air-dielectric, variable, 1.5-15 mmf., C33;
- One mica, fixed, 250 mmf., C34;
- One mica, fixed, 400 mmf., C35;
- One mica, fixed, 25 mmf., C36;

RESISTORS

- One Centralab type 72-115 control, 15,000 ohms, R1;
- One Centralab type 72-122 control, 0.1-meg., R2;
- One Centralab type 72-105 control, 0.5-meg., R3;
- One IRC, 300 ohms, 1-watt, R4;
- Three IRC, 100,000 ohms, 1/2-watt, R5, R13, R16;
- Four IRC, 1,000 ohms, 1 watt, R6, R11, R14, R17;
- Three IRC, 500 ohms, 1 watt, R7, R12, R15;
- Two IRC, 50,000 ohms, 1/2-watt, R8, R20;
- One IRC, 10,000 ohms, 1/2-watt, R9;
- Two IRC, 20,000 ohms, 1/2-watt, R10, R28;

- One IRC, 30,000 ohms, 1 watt, R18;
- One IRC, 5 megohms, 1/2-watt, R19;
- One IRC, 0.25-meg., 1 watt, R21;
- One IRC, 25,000 ohms, 1/2-watt, R22;
- Four IRC, 1.0 megohm, 1/2-watt, R23, R26, R29, R32;
- Two IRC, 15,000 ohms, 1 watt, R24, R27;
- Two IRC, 0.5-megohm, 1/2-watt, R25, R30;
- One Mallory-Yaxley, type 808, 8 ohms, R31.

TUBES

- One miniature-type 6.3 V., 0.15-A. base panel lamp;
- Three Sylvania type 6K7;
- Three Sylvania type 6C5;
- One Sylvania type 6A8;
- One Sylvania type 6Q7;
- One Sylvania type 6H6;
- One Sylvania type 6U5.

MISCELLANEOUS

- One antenna coil (Secondary from Meissner coil part No. 14-7636 with 2 primaries. Meissner part No. 14-6871. See text.), L1;
- One Meissner R.F. coil part No. 14-7638, L2;
- One Meissner oscillator coil, part No. 14-7680, L3;
- One Meissner crystal I.F., type 9-1005, L4;
- One Meissner interstage I.F. type 16-6643;
- One Meissner output I.F., type 16-6645, L6;
- One Meissner B.F.O., part No. 17-6779, L7;
- One Thordarson output transformer, part No. 781D52, T;
- One Mallory-Yaxley 3-way plug, No. 76, P1;
- One Amphenol heavy-duty plug, No. 92M, P2;
- One Amphenol Miniature 5-contact cable-type plug, No. 71-55, P3;
- One Mallory-Yaxley 3-way "Junior" jack, No. 702B, J1;
- One Amphenol heavy-duty female chassis socket, No. 92C, S1;
- One Amphenol Miniature 5-contact socket, No. 78-5H, S2;
- Nine Amphenol type MIP octal sockets;
- One Amphenol "eye" assembly, No. MEA6;
- One Triplett type 327A, 0-10V. D.C. volt-meter;
- Four Mallory-Yaxley type UB-241, Universal panel bushings and nuts;
- One Mallory-Yaxley type 432, molded twin tip-jack;
- One Mallory-Yaxley type 330, panel light;
- One Carter code No. 1740 AP genemotor;
- One pair Trimm featherweight 24,000-ohm phones;
- One Crowe No. 440 anodized tuning eye escutcheon;
- Six Crowe No. 408 anodized, no-name dial plates;
- Nine Crowe anodized plates, titled to suit;
- One Cutler-Hammer No. 3A S.P.S.T. toggle switch, Sw.1;
- One Cutler-Hammer No. 10A D.P.S.T. toggle switch, Sw.2;
- Two on-off switch plates;
- Six Crowe type 6141 knobs with pointers;
- 100-ft. Litz. loop wire;
- One National type TX-10 insulated shaft coupling.

For the Best of Service
OHMITE
RESISTANCE UNITS



Servicemen and Engineers everywhere have standardized on Ohmite Resistance Units for dependable, trouble-free performance. See Your Jobber for:

Cordohms—replace internal voltage dropping resistor in A.C.-D.C. radio sets. Also Tapped Cords for pilot lights.

Dividohm Resistors—Easily adjusted to resistance you want.

Brown Devils—10 and 20 watt resistors for voltage dropping, bias units, bleeders, etc.

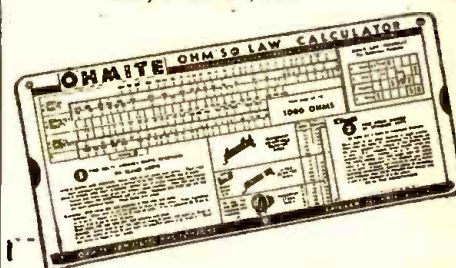

New OHMITE Ohm's Law Calculator

Solves any Ohm's Law problem with one setting of the slide! No slide rule knowledge required. All direct readings. Only 10c to cover handling cost. At your jobber or send coupon.

Ohmite Manufacturing Company
4894 Flournoy Street, Chicago, U.S.A.
10c in coin enclosed. Send Ohm's Law Calculator.

Name

Address

City State

Occupation Radio-Craft—April

OHMITE
RNEOSTATS RESISTORS TAP SWITCHES

ing such a strip don't forget that the curve of the "line" of screws may be slightly "S" shaped.

In case your organ has one bank of reeds on top of another, so that screws cannot be placed over the lower banks, cut strips of 14 gauge brass the same width as the reeds, round their end and grind or file each edge to a chisel point, i.e., flat on one side and beveled on the other side, so the strip can be driven into the top of the reed cell like the reed in the bottom. The sharp edges will cut their way in, but a hacksaw blade ground narrow enough to go into the cell should be used first. The end of the strip is tinned, and using a hole in a porcelain insulator as a mold, a cylinder of solder approximately the same diameter as the width of the reed tongue is cast on the strip. Its position can be adjusted lengthwise in the reed cell and when adjusting the intensity of output the solder is filed down, testing frequently with a visual output meter to be sure too much solder is not removed.

Figure 2 shows 3 banks on the lower manual of a 2-manual organ electrified by A. Bertram who developed this system. A total of 60 ft. of brass strip was used. The reeds may sometimes be reversed end for end, in their cell, and end pick-up may be employed either separately or in addition to top pick-up.

SHIELDING

Thorough shielding is absolutely essential unless you like 60-cycle hum with your music. Tinfoil glued to the wood of the swell shutters and windchest seems inexpensive and satisfactory (it produces the highlights in the background of Fig. 1). Tinfoil 3/1,000-in. thick may be obtained from dental supply houses. Avoid sheet metal shielding because it can vibrate thus causing capacity change and consequently audio feedback. Do not have any loose pieces of metal which make intermittent contact, such as octave coupler rods, inside the shielding as they will produce noise. Conducting paints could be used for shielding, but if the wood dries out and cracks, the shielding effect is impaired. Ground the shielding.

CONNECTING

The reeds on some organs are satisfactorily connected together by a wire between their tails and the felt strip on the windchest at the reed cell entrance (visible in the empty cell of lowest bank in Fig. 2). In other organs this proved a source of noise so a wire was soldered to the top of the tail of each reed (see the bright line in Fig. 1). This makes it awkward to withdraw the reeds for tuning or removal of any speck of dust which prevents the reed from speaking. Connect all the screws together by winding bare wire around their threads. Steel wire is less liable to break.

There are 2 methods of connecting to the amplifier. Both will now be described.

(1) In the Orgatron the screws are tied directly to the grid with a grideak to the "C" voltage and the "B+" is connected to the reeds through a condenser-resistor filter.

(2) In the condenser microphone circuit the screws are connected through an 0.01-mf. mica blocking condenser to the grid which has a 1/2-meg. grideak, to "C" bias, and the "B+" is applied to the screws (after decoupling filters) through a high (1/4-meg.) resistance. The reeds are grounded ("B-"). This reduces bass response but if you are weak on amplifier building and can obtain an old talking movie photocell amplifier, and merely connect the reeds and shielding to the shielding of the photocell cable and the screws to the central + photocell lead, then you will have connection 2.

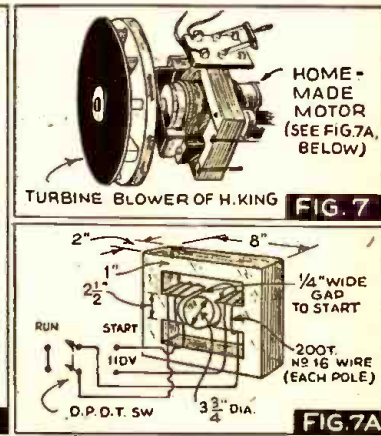
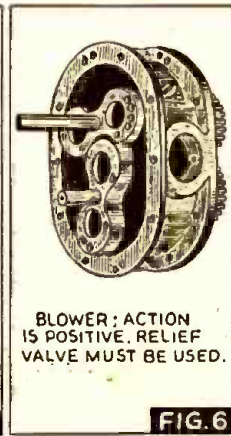
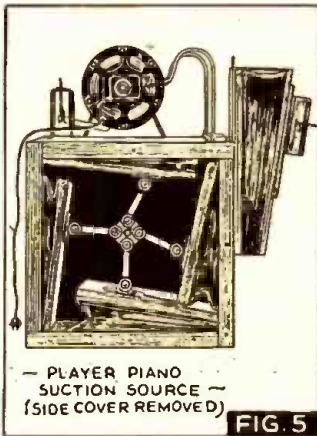
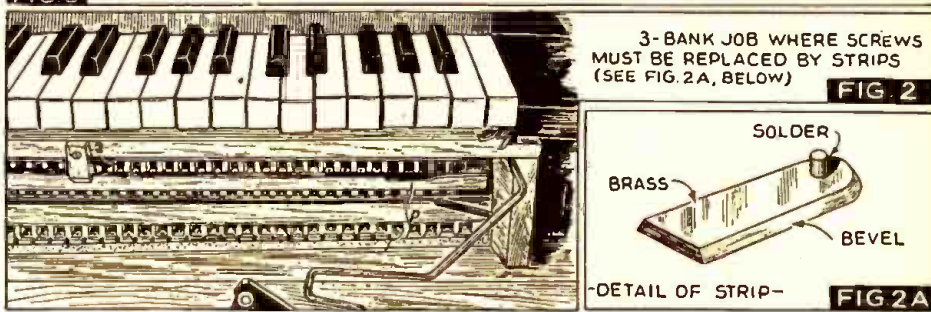
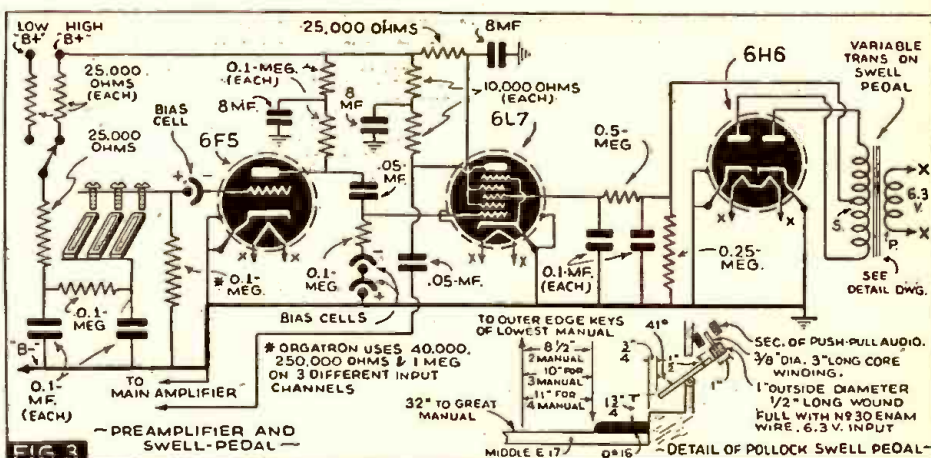

If end pick-up or bottom pick-up is used in conjunction with the top, reverse method No. 1 connecting the reeds to the grid, and each set of screws, i.e., top, end, bottom for this bank to its own potentiometer so any voltage + or - may be applied. In this way certain harmonics may be made to cancel and others add so that a wider variety of tones is possible. Miessner's article shows the harmonic analysis of several tones produced in this way from a single reed.

The use of strips of metal over the bass reeds instead of screws increases the bass output.

PREAMPLIFIER

Figure 3 is a suggested preamplifier with volume control or swell pedal. It was fed into the direct-coupled amplifier featured in past issues of *Radio-Craft* (only using a separate power supply for the screen) with excellent results. The audio system of a good broadcast receiver will do. Don't overload the amplifier or speakers as all reeds will then sound alike, and harsh cross-modulation tones will be produced when chords are played. Any overloading spoils the music.

The 6H6 rectifies the A.C. from the swell pedal and supplies it as negative bias to the injector grid of the 6L7. The swell pedal can be the windings from a push-pull input transformer with a movable iron core attached to the foot control. This Pollock swell

pedal permits several channels or manuals to be controlled independently, or all at once, by switching their injector grids onto the output of the swell pedal.

ADJUSTING THE SCREWS

Place the bass screws as close as possible without any chance of the reed tongue striking them when vibrating. (A piece of empire cloth glued over the end of the bass screws or a heavy coat of glyptal will prevent a click if the reed tongue should touch the screw.) Then the screws of the middle register will be farther away. Possibly the higher, narrower reeds may need the screws closer and the top few notes may need to be backed off. If any breaks are noticeable at the changing of the screws from one size to the next extend the large size farther along the scale and file down the diameter to produce a gradual change. One organ used the same size screws throughout, but to get balance between top and bottom of the manual the screws of the bottom half had to be supplied with higher voltage.

TUNING

Use a knife, razor blade, emery paper or file for the bass reeds. If flat, file off the tip to reduce the vibrating mass and so increase the frequency. If sharp, file near the fixed end to reduce the stiffness or restoring force and hence decrease the frequency.

Do not blow reeds by mouth, when tuning

NEW FM AUDIO AMPLIFIERS

Designed by A. C. Shaney

FREQUENCY RANGE: 13-30,000 c.p.s. ± 1 db
 POWER RANGE: 0.003 to 30,000 Milliwatts
 MUSICAL RANGE: 11 Octaves
 DYNAMIC RANGE: 80 db

Outstanding in their performance, construction, and appearance. These amplifiers were specifically designed for use with frequency modulation tuners, standard amplitude modulation receivers, and absolute fidelity phono reproducers. Load, by a wide margin, the very finest resistance, impedance or transformer-coupled amplifiers. Incorporate two basic AC and DC balancing circuits (pat. app. for) which provide greater circuit stability than conventional amplifiers.

Guaranteed for FIVE YEARS

Write for literature describing our FM Amplifiers

AMPLIFIER Co. of AMERICA

17 WEST 20th STREET NEW YORK, N. Y.



SAVE 60% OR MORE BY assembling your **FLUORESCENT FIXTURES** For HOME, WORKSHOP, STORES, OFFICES AND FACTORIES

UTILITY LIGHT COMPLETE KIT

\$1.95

plus postage

18 inches Long
 Beautiful bronze finish with white enamel reflectors

Anyone can assemble. Complete instructions furnished. All metal parts beautifully finished. Newest starter type electrical equipment fully guaranteed by us.

New shadowless, glareless light everyone is talking about, recognized as the greatest improvement in lighting since Edison discovered the electric lamp, can now be yours at a fraction of the regular cost. Your fluorescent light will give you twice the light of your incandescent bulb with less eye strain while using only one half the electricity. This will enable you to cut your light bill in two. Fluorescent lighting offers the greatest opportunity in America today for young men to establish themselves in their own business as trained sales and service men. Fixtures pictured on this page are now retailing for \$5.50 to \$10.00. Write now for complete details to learn how you can establish yourself in a very profitable business assembling and selling our complete line of Fluorescent fixtures. Be the first in your town.

Modern wall and ceiling fixture.

Complete kit

\$2.75

plus postage

BULB 70 cents extra

Polished metal and caps. White enamel body. Price includes switch

NATIONAL FLUORESCENT SALES AND SERVICE COMPANY Chicago, Illinois
 404 North Wells Street Dept. P

NEW AUDIOGRAPH Sound Catalog

AUDIOGRAPH Sound Systems represent the latest in Sound Engineering and Design—a complete line plus pre-tested accessories.

NEW LOWER PRICES

Outstanding quality and performance at prices that help you meet any competition.

WRITE FOR FREE COPY

JOHN MECK INDUSTRIES
 1313 W. Randolph St., Chicago, Ill.

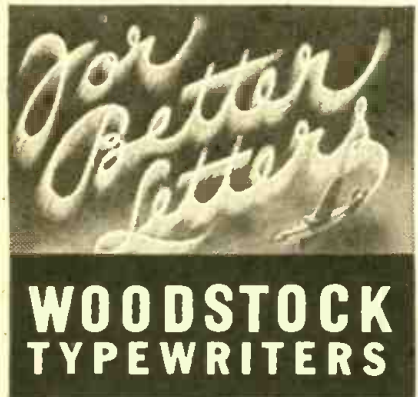

SELLING Better Than HOTCAKES!

We're in our THIRD PRINTING now on our AMPLIFIER HANDBOOK and still the orders keep pouring in. Looks like the AMPLIFIER HANDBOOK will be the best seller of the year. See page 614 for full details.

RECORDING ACCESSORIES

All rec. acc. from one source of supply. Four types of rec. blanks in usual sizes. Cutting and play-back needles, etc. New QSL rec. blank for amateurs. 1941 cat. just off the press. Everything for professional, home or experimental recording.

NATIONAL RECORDING SUPPLY CO.
 1065 VINE ST. HOLLYWOOD, CAL.

(due to variation in temperature and pressure), but hold over a hole in the windchest, or much better, in the actual cell with the pallet open the normal amount. For treble reeds place a razor blade under the tongue of the instrument for support and scrape the reed with another razor blade. A single scratch on the tip of a treble reed can raise the pitch materially.

It is easiest to tune against another organ. Listen to the beats and as their number is reduced go slowly or you will pass through zero-beat. The writer's ear tends to report "low" in checking the top octave of a 4-foot stop, i.e., the note seems to be in-tune while it is still flat. An electrical frequency doubler overcomes this. Many old reed organs are sharper than International pitch but it is no great task to drop one when tuned to a rotating electromagnetic organ.

If no standard is available the organ may be tuned from a table of frequencies, Fig. 4. The U. S. patent of L. Hammond, No. 1,956,350, sheets 17 and 18; or, I. Eremeeff, No. 1,990,024, sheet 2. Station WWV* almost anytime on 5 megacycles provides $A = 440$ cycles per second; or, use a disc with 22 notches on a 6-pole, 1,200 r.p.m. synchronous motor. Tune A to this using zero-beat.

Next sound *E* the "fifth" (or 7 semitones) above together with A so the 3rd-harmonic of A ($3 \times 440 = 1,320$ cycles) will heterodyne the 2nd-harmonic of *E* (1,318.510 cycles), and what will be heard will be their difference, or 1.49 beats per second which is 89 beats per minute. If this is not the case, tune *E* until it is. Then sound *E* the "fourth" (or 5 semitones) below together with A, and the 3rd-harmonic of A (or 1,320 cycles) will heterodyne the 4th-harmonic of *E* (1,318.510 cycles) the same number 89 beats per minute and *E* will be a dead octave (2:1) with the *E* above. If this is not the case tune this *E* below A until it is.

Now that A and *E* are correct, tune B the "fifth" (7 semitones) above the lower *E* until the 3rd-harmonic of *E* ($3 \times 329.627 = 988.881$ cycles) beats with the 2nd-harmonic of B (987.766 cycles) to produce their difference or 1.115 x 60 = 67 beats per minute. Then sound B the "fourth" (5 semitones) below together with *E* and tune it until it

* (Now rebuilding after the fire.)

beats at the same rate (67) as the "fifth" above *E* and is a dead octave with the B above.

Now that A, *E* and B are correct, continue with the "fifths" (7 semitone intervals)—B—F#, F#—C#, C#—Ab, Ab—Eb, Eb—Bb, Bb—F, F—C, C—G, G—D and D—A—tuning each "fifth" so the 3rd-harmonic of the lower note beats with the 2nd-harmonic of the top note the number of times calculated from the table; and the "fourth" below beats at this same rate and is a dead octave with the "fifth" above. The last "fifth" D—A should give the same A as you started with.

Tune one complete octave and then get the others from it.

The perfect "fifth" from A=440 (cycles) would be $3/2 \times 440 = 660$ so the *E* in the equal tempered scale just formed 659.255 (cycles) is flat. In other words, all perfect "fifths" are narrowed to beat at the same rate as the "fourths" below, which must be widened to keep the octave perfect.

In tuning strings where there are 3 per note, dampen the outside two with rubber or felt and turn the tuning wrench only while the note is sounding, or you will overshoot the correct point. When the center string is correct remove one damper and tune the second string to zero-beat with the first, when 2 are correct remove the remaining damper and tune the 3rd.

This whole job of tuning is not difficult to anyone who can understand heterodyne theory. As a check on your bass, B natural and B flat both beat at the same rate of 1.73 cycles per second with 60-cycle hum. Also every "fourth," e.g., C—F beats slightly faster than its adjacent "fifth," C—G.

BLOWER

Figures 5, 6, and 7 show suction supplies. A vacuum cleaner works if you can box it in enough to be quiet. The blades of a blower made convex in the direction of rotation are quieter than straight blades. (See page 597A in April '40 Radio-Craft.) An eccentric with reduction pulley to work the regular organ bellows will do. The side of the player piano bellows in Fig. 5 was replaced with one having an outlet as shown and another set of reeds operated with force wind, instead of suction, works from the same pump.

The description of Mr. H. King's home-made motor in Fig. 7 is as follows:—Laminated frame 8 ins. square x 1 in. wide and 2 ins. thick. Pole pieces $2\frac{1}{2} \times 2$ ins., 200 turns of No. 16 D.C.C. on each pole. Armature, old car combination starter-generator armature $3\frac{3}{4}$ ins. dia. with commutator shorted. Reluctance-start by a $\frac{1}{4}$ -in. wider pole gap at the leading edge of each pole and a D.P.D.T. switch to connect the fields in parallel for starting and in series for running. Fan about 12 ins. dia., blades $\frac{1}{4}$ -in wide, curved, speed 3,500 r.p.m. Total cost of complete blower was slightly over \$1.00 plus hours of work. A totally enclosed, spring-suspended or rubber-mounted turbine, or the bellows are the only suction sources quiet enough to include in the console.

PNEUMATIC ACTION

A Willis Ampico player action was obtained cheaply.

(Pianos with player actions are stiffer, and now that they are out of style, music stores sometimes remove the player part of the action to allow the keys to work easily.) Be sure to get an action in which the tiny bellows can be moved from one end to fill in the spaces where the metal braces of the piano action are. Some player actions have the necessary openings at these spaces, glued over with cloth, while others which have not, are useless, because although reed

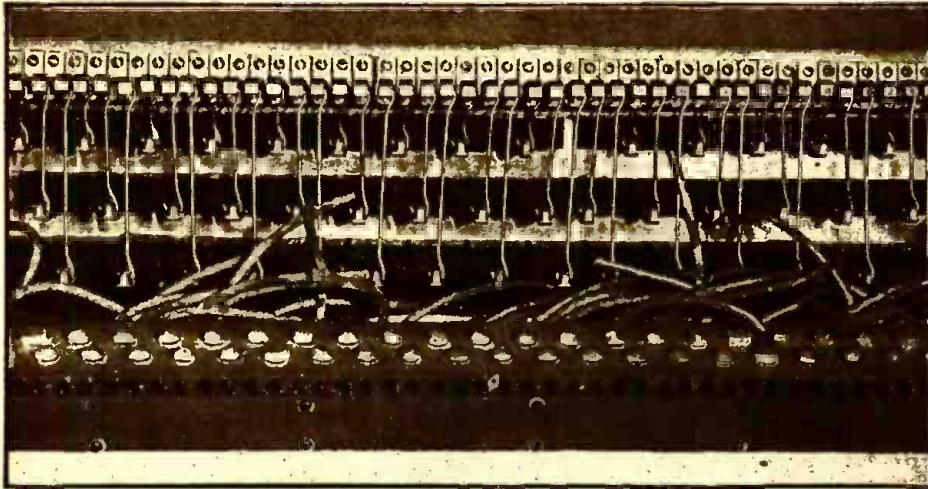

Fig. 8. Player action showing how bellows have been moved from ends to fill spaces where piano action braces were. Note that valves have not been moved in as this is unnecessary. Armatures can be attached to these valves to permit them to be opened by magnets.

organ spacing is the same as the piano, there are no intervals in the spacing of the reeds, as there are in the strings.

This action can be operated from an old pneumatic-action pipe organ keyboard by having the keys admit air to holes in a board replacing the paper player roll. Or by fastening iron armatures to the wooden ends of the little valves (Fig. 8) electromagnets controlled from the keyboard can operate the action. Sometimes in modernizing pneumatic pipe organs, electrically-operated valves are connected to the lead pipes. A set of these would be ideal. Remember the valves of the player action won't work when placed upside down.

The action and reeds could not be operated satisfactorily from the same suction source because the action needs high pressure with small volume whereas the reeds required low pressure with large volume. However, the reeds and 1 note at a time of the action (e.g., for a melody or pedal coupler) would work from a single wind source.

It is very difficult to prevent interference from manual contacts being picked up by the electrostatic pick-up screws. One manual wired with No. 30 wire produced much less interference than the manual wired with the customary (lower resistance) No. 22, so that resistance wires to the contacts seem to aid greatly in suppressing keyclicks. Because of the possibility of keyclick interference pneumatic action would seem preferable to magnets placed near the reeds. Moreover pneumatic action enables the organ to be placed some distance from the console. Also it permits sub, super, inter-manual and pedal coupling, without increased key resistance; and it produces faster speech in the bass reeds. However with pneumatic action, keyboard touch is lost; i.e., with the keys operating the pallets directly, *considerable control of the tone can be obtained by pressing the key to different depths with various speeds*, while with pneumatic action as soon as the key admits air into the action the pallet is instantly opened to its maximum distance. Thus pneumatic action is scarcely worth the trouble for notes above the middle of the manual at least.

TREMOLO; INTENSITIES; CONSOLE; OTHER METHODS

An aluminum disc, induction-type phono motor with governor and turntable removed, and a 10½- x 12½-in. fibre shutter (which is enlarged or reduced to keep the speed approximately 6 revolutions per second), makes a fine tremolo when placed in front of the loudspeaker. Use a ¼-in. square stick

about 10 ins. long with a tapered hole in one end to slip over the turntable shaft, and slotted lengthwise at the other end to hold the shutter.

Two or 3 intensities may be set up on each stop by changing the polarizing voltage or amplifier input resistors.

Wrapping the reed action in felt reduces the direct sound and keeps dust out of the treble reeds.

If the reeds are included in a pipe organ console the wider spacing of pipe organ keys may be matched to the reed action by extensions placed on the rear of each key offset toward the center. Leather nuts must be used on threaded rods to the pallets because the vibration will loosen metal nuts.

Steel (accordion) reeds can use electro-magnetic pick-up. Photoelectric pick-up from pedal-controlled dial lamps behind bass reeds being blown continuously overcomes their slow action.

This concludes the description of the Electronic Organ. Only those who are seriously interested in building such a device should undertake what is unquestionably an ambitious enterprise. True, the results will be worthwhile, but unless the constructor can see his way clear to carrying the project through to completion, it would be wiser not to begin it. Otherwise, we say, "go to it!"

ANALYSIS OF THE ELECTROSTATIC TYPE OF ELECTRONIC ORGAN

ADVANTAGES

- (1) Separate reeds produce ensemble or choir effect not found in mechanical electric organs.
- (2) Build up of tone or attack in middle and upper registers resembles a pipe.
- (3) Lovely flute and diapason pipe organ tones are produced, in no way resembling the reed organ tone.
- (4) Reasonably easy to build.
- (5) Inexpensive to build.

DISADVANTAGES

- (1) Requires tuning.
- (2) Bass notes are too slow in attack.
- (3) No trumpet or Vox Humana, etc., stops.
- (4) No fundamentals higher than a 4-foot stop without excessively small and fragile reeds.
- (5) Affected by temperature, pressure, humidity and dust.

HOW TO SAVE ON EVERYTHING IN RADIO

Just off the press! ALLIED'S new Spring Catalog—cramped with amazing values from cover to cover! ALLIED offers you everything new in Radio, real savings and fast service. Dealer, Serviceman, Soundman, Builder, or Amateur—whatever your interest in Radio, you'll find the new ALLIED Catalog a necessity! Send for your FREE copy today. Keep it handy for speedy reference!

NEW RADIO SETS VALUES IN P. A.

See them all—1941's Radio Hits! Models for every purpose. Every one a Champion—new "Personal" three-way Portables; latest Recorders; Phono-Combinations; Plastic Sets; World-wide Models; new FM-AM receivers; Auto and Farm Radios; Amateur Sets—all at lowest prices that spell Real Savings and Profits for You!

25 New Sound Systems! For every Public Address application—7 to 75 watts. Widest selection; finest features. Easy Payment Plan and 15 Day Trial. Complete P. A. accessory listings for every purpose. Dollar for dollar, you get more when you buy 1941 KNIGHT Sound Equipment. Send for your FREE catalog now!

FOR THE BUILDER 15,000 RADIO PARTS

If you build your own, you can count on ALLIED for the latest low-cost kits and for help in building any type of radio circuit. Complete listings of the latest builders' and experimenters' supplies. New diagrams, Complete Ham gear for the Amateur. ALLIED is Headquarters for Radio Builders! For Radio Amateurs!

The biggest selection of quality parts in all radio. Every leading make—complete listings for every radio replacement and servicing requirement. Parts, tools, test equipment, books, etc. You need this reliable Guide to Everything in Radio at the lowest prices! Don't be without it! Don't wait! Mail coupon TODAY!

ALLIED RADIO

833 W. Jackson Blvd., Dept. 2-D-1
Chicago, Illinois

Send me your FREE 180-Page 1941 Spring Catalog. **FREE**

Name

Address

City State

RADIO DEVELOPMENTS

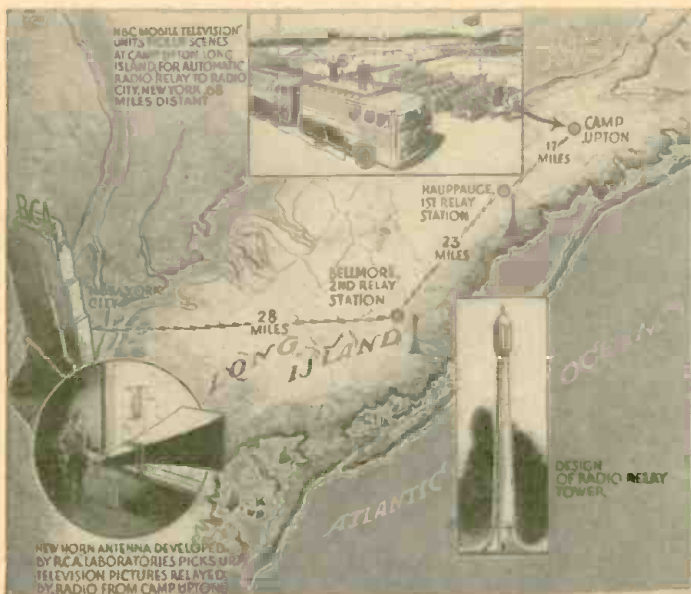

68-MILE TELEVISION RELAY

Artist's drawing of the television radio relay system developed and operated by RCA on Long Island. As demonstrated for the F.C.C. and National Television System Committee, the N.B.C. mobile television unit located at Camp Upton flashes the "picture" signals across to Hauppauge, where an automatic, unattended 5-watt radio relay station intercepts the signal and "bounces" it over to Bellmore. Two new *horn* antennas in a window on the 62nd floor of the RCA Building at Radio City, point toward Bellmore and pick up the relay signal.

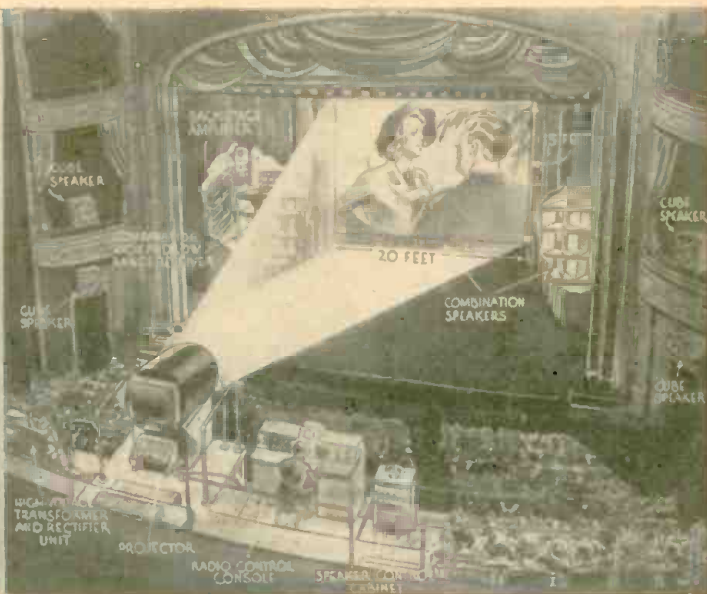

THEATRE-SCREEN-SIZE IMAGES

Theatre television projector, developed by RCA Laboratories, operating in conjunction with a "multisonic" sound system, as demonstrated at the New Yorker Theatre for the Federal Communications Commission and National Television System Committee. The operators at the control desks regulate the focus, brilliancy and sound volume of the 15 x 20 ft. "teletictures." Eighteen high- and low-frequency loudspeaker systems scattered throughout the theatre are used in the "multisonic" arrangement.

THEATRE SCREEN-SIZE TELEVISION

Newest developments in television were shown to the Federal Communications Commission and the National Television System Committee, last month, by one of several laboratories. Startling even to seasoned Radio-Craft representatives, the dynamic manner in which these developments were presented augers well for their entertainment value. New "horn" antennas, multiple DX relays, "orbital beam" tube, multiplexed F.M.-sound (and/or facsimile) and A.M.-images, and theatre-screen-size reproduction with occasional 18-speaker "multisonic" sound characterized one of the demonstrations, as here described.

LAST month, the Federal Communications Commission and the National Television System Committee made a whirlwind tour of outstanding television laboratories, most of which were located in the vicinity of New York City. Following is a description of the results (of

experiments extending over the period since the F.C.C. set commercial television back on its heels by suspending its OK of operating standards) demonstrated by only one of these laboratories!

(Also demonstrated by this same laboratory, but not described here in detail, was

a home-television receiver having an image size of 13½ x 18 inches [about 1 x 1½ ft.]) A 5-in. projection-type cathode-ray tube and a coated-lens optical system were used.)

Let's see first what sort of program material was offered on the program, and how this material was picked up, transmitted

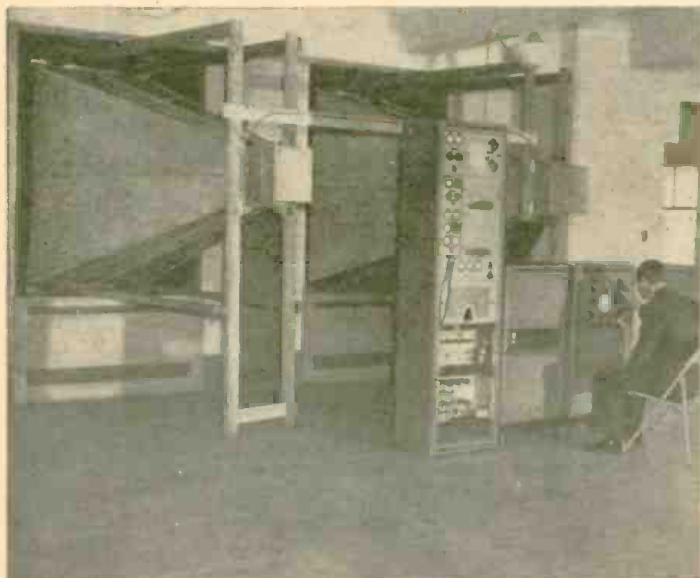

"HORN" ANTENNAS

New horn antennas installed in windows on the 62nd floor of the RCA Building intercept the television signals relayed by radio 68 miles from Camp Upton via Hauppauge and Bellmore. The ultra-shortwave radio receiving equipment is seen in the right foreground.

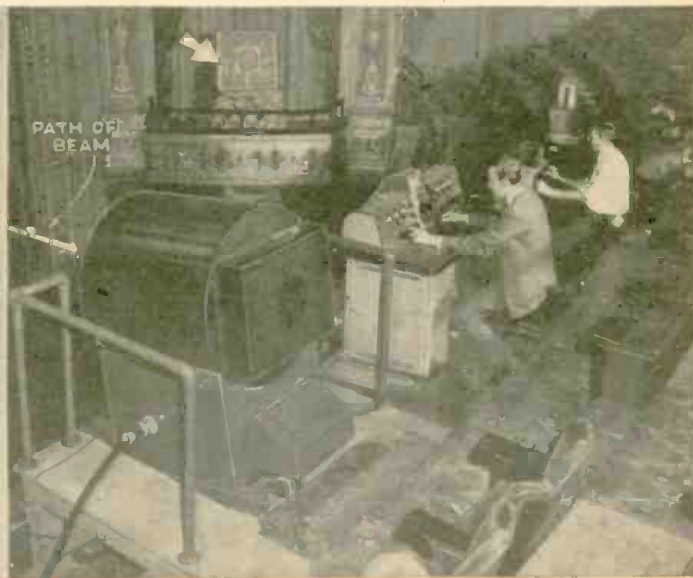

"MULTISONIC" SOUND

Television projection equipment installed in the balcony of the New Yorker Theatre to project 15- x 20-foot images on the screen 60 feet away. In foreground, the steel-jacketed projector; at right, control desks for images and "multisonic" sound (arrow points to one of 18 loudspeakers).

over a "DX" (long-distance) relay system, and shown to the group of technicians assembled in a motion picture theatre specially equipped for the occasion.

Undoubtedly, the most dynamic portion of the program was the manner in which the "multisonic" sound system, a manually-controlled version of the high-power sound reproduction technique incorporating an automatically-controlled sound track as utilized in Walt Disney's "Fantasound" picture(*), was employed during the televising of a film sequence in the composite studio-and-film spy thriller, "K-7," in which an "enemy" airfield was bombed out of existence. One could feel his chair vibrate at each detonation. It was no place for a born pacifist! Next in interest was the demonstration, earlier, of activities at Camp Upton, Yaphank, Long Island, (N.Y.). It was thrilling to watch a group of our "1-year" boys loading and unloading an anti-aircraft gun at the rate of 30 shells a minute.

But let us now take you on a behind-the-scenes "conducted tour" of this demonstration just as though you were there.

RADIO RELAYS AND ORBITAL-BEAM TUBES

The automatic radio relay of scenes from Camp Upton, Long Island, to New York, brings into use the new unattended radio stations which "bounce" television images across the countryside without the use of wire connections.

This radio relay system, developed by RCA Laboratories, incorporates a number of engineering features and innovations in communication. The relay towers, as designed for future use, are envisaged dotting the landscape to make possible inter-city television and eventually a television network on a national scale. (See cover "spot" relay-tower illustration; the relationship of this tower to the relay system is shown in the heading illustration on page 624.—Editor)

Inside the "beacon" on top of the tower is a new horn antenna (***) sharply directional in reception and transmission of ultra-short waves. The towers vary in height, depending upon the terrain and distance to be covered. The automatic apparatus for amplifying and relaying is located in the base of the tower. In a split-second after the pick-up and amplification of the signal, the images are "search-lighted" in the desired direction.

The mobile units of the National Broadcasting Company, stationed on this occasion at Camp Upton, televise and flash the Army "pictures" on the 165-megacycle channel to Hauppauge, 17 miles distant. Hauppauge's automatic relay station intercepts the images and tosses them across 23 miles on 474 megacycles to a horn antenna 200 feet up on a mast formerly used by WEAf at Bellmore. There again, amplification strengthens the image-carrying impulses for relay on 506 megacycles to New York, 28 miles beeline.

Protruding from a window on the 62nd floor of the RCA Building at Radio City, 2 horn antennas with their open mouths pointed in the direction of Bellmore, pick up the incoming ultra-short waves that carry the telepictures. These horns, from their 4- to 6-foot openings, taper along the 8-foot length to an apex about 1½ feet square, where a dipole antenna is located. The impulses are fed into the television sets at Radio City, and are also sent over a special wire line to the "New Yorker Theatre" for projection on the 15- by 20-foot screen. *The images are 441 lines, 30 frames.*

(*) See "Fantasia" Introduces "Fantasound," Radio-Craft, Feb. '41.
 (***) See "Ultra-shortwave Horns," Radio-Craft, Aug. '40, pg. 72.

BARGAIN SPECIALS FOR DEALERS SERVICEMEN EXPERIMENTERS

RCA LICENSED TRIAD TUBES

12A	6A8GT	6K6GT	6U5G	Specially priced at
2A5	6C5G	6K7G	12K7GT	
6A7	6B5	6N6G	25A7G	
2B7	6F5G	6Q7G	25L6G	
6A8G	6F7	6X5G	25Z6G	
MANY OTHER POPULAR TYPES IN STOCK				

24c

Compact Electrolytic Tubular Type Condenser
 16-40 MFD at 150 V. D.C. working. 20 MFD at 25 V. D.C. working. common neg. Real Value **13c**

A Heavy Duty Electro-Dynamic 8" Speaker
 while they last **89c**
 1000 ohm field complete with pentode output transformer

Constant Speed Phono Motor
 Self Starting 78 RPM 110 volts 60 cycles A.C. Amazingly priced **\$1.89**

High Gain Litz Wound Antenna and RF Coils
 for TRF Midget Sets for use with 365 mmfd tuning condenser Special per pair **17c**

SPECIAL FREE OFFER!
 A Handy Gift for Servicemen given ABSOLUTELY FREE with every order received from this ad.

FEDERATED PURCHASER INC.
 80 PARK PLACE DEPT. R-41 NEW YORK CITY

A NEW BOOK TO ADD TO YOUR TECHNICAL LIBRARY
AUTOMOBILE RADIO — Principles & Practice
 by B. Baker Bryant



A COMPLETE compilation of pertinent data on how to install and service the modern automobile radio receiver. All of the non-essential details which have crept into the profession have been weeded out. Each topic is treated so as to contain a precise statement of the fundamental principle involved, to assure the reader's clear understanding of this principle, without distracting his attention by the discussion of a multitude of details and mathematical expressions, which are primarily for the engineer, and tend to confuse rather than clarify a statement for the auto-radio technician. A practical treatise based on practical experience by practical radio people for the practical radio-technician.

Brief Outline of Contents—

- Introduction—The Auto-Radio Art.
- Features of the Modern Automobile Receiver.
- Installations of Automobile Radios and Antenna.
- The Automobile High and Low Tension Electrical Systems.
- Automobile Electrical Disturbances.
- Vibrator Converters and Motor Generators.
- Service Hints, Classified Automobile Installation Notes, and Conclusion.

Send 50c check, money order, unused U. S. stamps, or coin for your copy of "Automobile Radio—Principles & Practice"—it will be sent to you postpaid upon receipt of your remittance.

RADCRAFT PUBLICATIONS, Inc.
 20 Vesey Street, New York, N. Y.

In no instance does the power of the intermediate relay stations exceed 5 watts, an accomplishment attributed in part to the highly directional horn antennas.

Another device of considerable importance to the system is a new RCA tube technically described by the engineers as of "the inductive output type." With this tube, amplification of the television signals at the relay stations is effected at radio frequencies instead of the original frequency of modulation. This tube makes possible the streamlining, simplification, efficiency and economy of operation of the radio relay stations.

Taking further advantage of new developments in radio tubes, the relay system in the low-power stages (receiving circuit)

utilizes a new "orbital beam" tube. Operating in general on the *electron multiplier* principle, this tube is a new means of obtaining high amplification on ultra-high frequencies.

THEATRE-SCREEN TELEVISION

Large-screen television equipment projects a 15- x 20-foot "picture" on the screen in the "New Yorker Theatre," 254 West 54th St. There is featured, in addition to new developments in projection, a new *multi-sonic* sound system developed by RCA Laboratories for use with the television screen.

A steel-barreled projector pointed over the edge of the balcony casts the television

GEOPHYSICAL PROSPECTING OUTFITS



BLUE PRINTS and INSTRUCTIONS

For Building the Following Treasure Finders and Prospecting Outfits

- Folder No. 1. The "Radioflector Pilot"—consists of a 2-tube transmitter and 3-tube receiver. Principle: radiated Wave from transmitter loop is reflected back to receiver loop. Emits visual and aural signals. Tubes used: two 1A5G—two 1N5G—one 1H5G.
- Folder No. 2. The "Harmonic Frequency Locator"—Transmitter radiates low frequency wave to receiver, tuned to one of Harmonics of transmitter. Using regenerative circuit. Emits aural signals. Tubes used: one 1G6G—one 1N5G.
- Folder No. 3. The "Beat-Note Indicator"—Two oscillators so adjusted as to produce beat-note. Emits visual and aural signals. Tubes used: Three type '30.
- Folder No. 4. The "Radio-Balance Surveyor"—a modulated transmitter and very sensitive loop receiver. Principle: Balanced loop. Emits visual and aural signals. By triangulation depth of objects in ground can be established. Tubes used: Seven type '30.
- Folder No. 5. The "Variable Inductance Monitor"—a single tube oscillator generating fixed modulated signals and receiver employing two stages R.F. amplification. Works on the inductance principle. Emits aural signals. Tubes used: six type '30.
- Folder No. 6. The "Hughes Inductance-Balance Explorer"—a single tube Hartley oscillator transmitter and sensitive 3-tube receiver. Principle: Wheatstone bridge. Emits aural signals. Tubes used: two type '30—one type '32—one type '33.
- Folder No. 7. The "Radiodyne Prospector"—a completely shielded instrument. Principle: Balanced loop. Transmitter, receiver and batteries enclosed in steel box. Very large field of radiation and depth of penetration. Emits aural signals. Tubes used: two 1N5G—one 1G4G—one 1H5G—one 1Q5—one 1G4.

With any one of the modern geophysical methods described in the Blue-Print patterns, Radio outfits and instruments can be constructed to locate metal and ore deposits (prospecting); finding lost or buried treasures; metal war relics; sea and land mines and "duds"; mineral deposits; subterranean water veins; oil deposits (under certain circumstances); buried gas and water pipes; tools or other metallic objects sunken in water, etc., etc.

Each set of blueprints and instructions enclosed in heavy envelope (9½" x 12½"). Blueprints 22" x 34"; eight-page illustrated 8½" x 11" fold. **50¢** or instructions and construction data. Add 5¢ for postage

The complete set of seven folders..... **\$3.00**
Shipping weight 2 lbs. (add 25¢ for shipping anywhere in U.S.A.)

TECHNIFAX

RC-441 CHICAGO, ILL. 1917 S. STATE ST.

TECHNIFAX 1917 So. State, Chicago, Ill.

Enclosed herewith \$..... for which mail to address below:

Treasure Finder No. 1, 2, 3, 4, 5, 6, 7.
Complete set of seven folders.

NAME

ADDRESS

CITY STATE

RC-441

images on the stage screen 60 feet distant. Alongside the projector are control desks at which operators manipulate the knobs that regulate the image and sound. These operators exercise the same control over faces and scenes as radio control men do over broadcast music and speech. The "pictures," as they come over the wire from an outside point, are received first at the control desk to be fed into the projector. The Camp Upton scenes relayed by radio to the RCA Building are forwarded from Radio City to the "New Yorker Theatre" over special wire circuits.

The sound reproduction system used in connection with the theatre television unit is of the extreme-high-fidelity type, similar in effect and arrangement to the "Fantasound" used in the motion picture "Fantasia." Differing from Fantasound in that it is manually controlled at the scene of reproduction, the multisonic system permits movement of sound with action on the screen; rotation of sound around the walls of the auditorium; and, emanation of sound from any one desired point in the theatre.

Developed in the RCA Laboratories, the large-screen theatre television system operates on signals delivered to it either by coaxial cable or by special wire circuits.

The installation in the theatre consists of 3 main units: (1) control, (2) power supply, and (3) optical system.

An array of knobs and dials on the control panel gives the operator immediate handling of all controlling, metering, and deflecting elements. He can obtain at any time, every possible check on the operation of the system. Sharpness, brightness, contrast, and size of the image projected may be changed by the turn of a knob. The controls are so simplified that the average motion picture projectionist could operate the unit with but slight training.

The second unit, the power supply for the optical or projection system, is a conventional high-voltage rectifier rated at 70,000 volts. Normally, operation is at 60,000 volts.

The optical, or projection unit, is considered the most important as well as the most complicated of the entire system. For purposes of description, it is possible to divide the unit into 3 principal elements; that is, (1) the kinescope, or projection tube; (2) the reflecting mirror, and (3) the correcting lens, or plate. (†)

The kinescope, built to handle high voltages, is similar in performance to the kinescope used in RCA's standard home-television receivers. The face or diameter of this cathode-ray receiving tube is 7 inches; the tube's length is 14 inches. It is mounted in the center of a hollow steel-shielded cylinder 34 inches in diameter and 34 inches long. The face of the tube is pointed away from the stage screen, and the end of its neck pierces a small hole in the center of the correcting plate of the optical system.

The concave reflecting mirror, 30 inches in diameter, is mounted a few inches in front of the tube's face. The image on the face of the tube is picked up on the concave surface of the mirror, passed through the correcting lens and onto the screen with a magnification of 45 times. The lens corrects for aberrations and passes the image across the auditorium to the stage screen.

The optical system is unique in that it has a speed rating of f:0.7, which surpasses the fastest known projection lens. It was developed by research engineers in the RCA Laboratories, and is a variation of the Schmidt astronomical camera. Optical ex-

(†) This arrangement is shown by diagram in "Newest Screen-size Television," Radio-Craft, Aug., '40.

pers viewed the idea in the beginning as impractical, but one of the RCA engineers, whose hobby is optics, figured out a formula, devised special grinding instruments, and successfully developed the optical system! The first unit required 6 months to produce, but the technique of grinding the lens was improved to the point where the one used today was ground in 6 weeks.

The optical unit housing is mounted on a pedestal which contains the video amplifiers and the deflecting output circuits.

Controls for the sound, which accompanies the television projection, are mounted in a separate console, adjacent to the television control desk. They are linked to 18 high- and low-frequency loudspeakers mounted around the auditorium. Wire lines connect the console with the N.B.C. studios and with the central radio receiving point in Radio City. In addition, there are lines which the sound control engineers use for cueing the program.

Three banks of regular RCA Photophone (motion-picture-theatre type) speakers are set up on the stage near the screen. One bank is at the rear of the screen, and the other two are at either side. Beginning at the outer edge of the proscenium arch, other loudspeakers are located at desired points along the side wall and in the rear of the auditorium. One large loudspeaker is suspended from the ceiling. Thus the sound can be given directivity and height.

MULTIPLEXED FACSIMILE AND "F.M." SOUND

Utilizing a single Frequency Modulated ultra-short-wave channel to perform 2 services simultaneously, facsimile and high fidelity sound, the RCA Laboratories have developed a new method of radio multiplexing.

Microphones in an N.B.C. studio in the RCA Building feed sound over a wire to the "F.M." transmitter in the Empire State Building, while the facsimile machine operates in a laboratory at Radio City. A wire line also links the facsimile scanner with the transmitter. The electrical currents, one carrying sound, the other printed matter or pictures (photographs, drawings, etc.), are combined at the transmitter to modulate a 1-kilowatt F.M. station operating on 45.1 megacycles.

In the demonstration the sound and print signals are detected by a receiver at Radio City. The duty of the receiver is to "unscramble" the sound from facsimile, and reproduce both to correspond with the original transmission. Electrical filters do the trick. Then the sound is fed into a high-fidelity loudspeaker. The facsimile signals actuate a carbon-paper recorder capable of reproducing printed matter, drawings, maps, pictures, etc. The machine, performing this double duty, is about the same size as a standard radio-phonograph console.

The F.M. channel is 200 kilocycles wide. For the high fidelity sound (30 to 15,000 cycles) 150 kilocycles of the channel are used; for the facsimile impulses, approx. 30 kilocycles. The remaining 20 kilocycles are utilized as guard bands to keep the sound and facsimile apart.

The facsimile instrument prints on a strip of paper 8 inches wide. Printing speed is 1¼ inches a minute, making it possible to reproduce a message the size of a business letterhead or an 8- by 10-inch picture in less than 10 minutes.

And so, dear reader, we conclude this particular jaunt with the F.C.C., et al. Illustrations and brief descriptions of other demonstrations in this series appear in the Radio Month in Review department of this issue.

RADIO INTERFERENCE FROM ELECTROMEDICAL APPARATUS

Extracts from an address by E. K. Jett, Chief Engineer of the Federal Communications Commission, at the 19th Annual Session of the American Congress of Physical Therapy, Cleveland, Ohio, Sept. 2, 1940.

INTERFERENCE is the problem child of radio. If it were not for interference, one of the principal reasons for Government regulation of radio would be lacking.

Radio interference is of 3 kinds. Except under special conditions, radio stations can interfere with one another unless they are assigned separate frequencies—that is, separate highways in the ether. This kind of interference is taken care of through Government regulation and international agreement. Every station is assigned a specific frequency or channel and is required to operate within this channel.

The 2nd type of interference is caused by Nature—thunder storms or electric discharges, which listeners call "static" or atmospheric noise. There is always a varying amount of atmospheric noise present in radio reception. This type of interference is overcome in large measure by assigning sufficient power to radio stations to override the noise (or by using "F.M."—*Editor*).

The 3rd type of interference is industrial—electrical or man-made. It is caused by electric machines used in the industry or the home, such as oil burners, electric razors, automatic sign flashers, and the like. Automobile ignition and electric railways are other producers of interference. Fortunately, this 3rd type of interference travels a very short distance from the source. It has been possible to control it to a large extent through cooperation between manufacturers, radio operating companies, and the user of the equipment.

ELECTROMEDICAL STATIC

The interference caused by diathermy equipment appears in a class of its own! (Italics ours.—Editor) It is not only capable of interfering with radio reception but in many cases is actually now doing so.

The Federal Communications Commission recognizes the importance of electromedical apparatus to the medical profession in the treatment of human ills. As a matter of fact, the Inter-American Radio Communications Arrangement, signed at Santiago in 1940, specifically states that the use of diathermy apparatus has an important place in therapeutics, surgery, and industry. The immediate problem, therefore, is how may the public enjoy the benefits of radiocommunication as well as those resulting from the use of electromedical apparatus without conflict between these services.

The Commission has been studying this problem for several years and has received excellent cooperation from the Council on Physical Therapy and other interested parties. A number of States and municipalities have enacted statutes and ordinances to deal with the subject. However, the general problem of interference has been approached by the Commission from the point of view that the public as a whole will be best served through cooperation in the industry. The Commission believes that through further cooperation it will be able to adopt standards of good engineering

As *Radio-Craft* has reported, diathermy interference is perhaps the most pernicious form of "noise" that can be experienced in radio reception; the radiations of one machine, set up in a New England hospital, having been received in England (and positively identified by means of special, coded interruptions of the output)! Even Frequency Modulation receivers, immune to all ordinary forms of interference, in some instances succumb to the radiations of diathermy machines installed without due regard to the problem of radio interference.

Photo—From a construction article in *Radio & Television Magazine* (Feb. '40 issue).

practice to guide manufacturers and users of electrical equipment and thus prevent radio interference.

However, local interference in the broadcast services is not the greatest cause for concern in this problem. Transmissions from diathermy machines are capable of being received across the continent and even across the ocean. The frequencies upon which they operate are used by the national defense and safety services. Interruptions of these services may jeopardize life or property, or seriously affect the nation's interests. Communication companies appeal repeatedly to the Commission as being their only source of relief from these interruptions. Municipalities, as many as thirty at a time, have also petitioned the Commission for assistance in the protection of their police services. (Italics ours.—Editor)

Any curtailment of diathermy apparatus would cause great hardship to many sufferers and would prevent the saving of many lives. No one would suggest such a step. Diathermy, like Radio, is a safety service. It is used by physicians and surgeons in many ways to combat disease and for surgical purposes. In the hospital it has become an indispensable tool. There are thousands of therapeutic departments in hospitals in the United States, all of which possess one or more diathermy machines, and there are thousands of privately-owned machines being operated by physicians in this and other countries. The Commission would no more want to prevent the use of these machines than it would seek to curtail the activities of the doctors themselves. But it is confronted with a very serious problem. It must find a way in which diathermy and radio can get along together.

The reason operation of diathermy apparatus affects radio reception is that the machines are essentially radio transmitters. The radiation which results in interference is not essential for therapeutic purposes and may be regarded as a by-product of the means used to attain the objective. It can, however, be eliminated or minimized if reasonable methods are employed.



SOLVING DIATHERMY PROBLEM

From an engineering standpoint, the solution of the problem is simple. While economic factors are important, they are not of such great importance as to be regarded as being unreasonable from the standpoint of cost to the users of therapy apparatus.

In those cases where it is necessary to take the apparatus to the patient, in circumstances where screening the room is not practicable or advisable economically, or, if for any other reason entire screening of the patient and the apparatus is not possible, it would appear that the only solution would be to use apparatus with a restricted frequency band of emission which does not extend over more than one communication channel. This channel should be selected to avoid interference with radio reception.

This problem was considered in detail at the Inter-American Radio Conference held in Havana in 1937, and again at Santiago in 1940. It is significant that the question was an important topic for discussion at these meetings. There are international aspects. For example, the diathermy machines in Mexico or in Canada cause interference with reception in the United States, and vice versa.

A report prepared by the Canadian delegation and adopted at Havana gives the results of a very comprehensive study of diathermy interference and of the most effective and economic methods of suppressing it. Details as to the different kinds of shielding, their costs, and the manner in which they may be applied to rooms, walls, doors, etc., in hospitals and offices are given. (Also see "Radio's 'Old Man of the Sea'," *Radio-Craft*, March 1937, pg. 536.—*Editor*)

DIATHERMY WAVELENGTH

Representatives at Santiago agreed that their respective countries should adopt measures to suppress or alleviate, insofar as possible, interference caused by apparatus or equipment which may generate or radiate radio-frequency currents capable of interfering with, or adversely affecting, the reception of radio transmissions. In this con-

SUPER SPECIALS

All of the attractive items listed here are brand new. ALL are in PERFECT WORKING ORDER. In many cases, the parts alone total more than the price we are asking. 100% satisfaction guaranteed or your money refunded.
ORDER FROM THIS PAGE. Use the convenient coupon below. Include sufficient extra remittance for parcel post charges, else order shipped express, collect. Any excess will be refunded. C.O.D. shipments require 20% deposit. If full remittance accompanies order, deduct 2% discount. Send money order, certified check, new U. S. stamps. No C.O.D. to foreign countries.

ORDER TODAY LIMITED QUANTITIES PROMPT SHIPMENTS ASSURED

VARIABLE SPEED UNIVERSAL MOTOR

FOR 110 VOLTS, A.C. OR D.C.

Made for Dictaphone machines by American Gramophone Co. Used, but in excellent condition. Special lever control permits variable speeds up to 3000 r.p.m. 1/4" shaft extends from both sides of motor. Measures 7 1/2" x 3 1/4" diam. overall. Shp. Wt. 0 3/4 lbs.

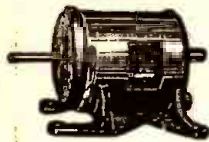

ITEM NO. 11
 YOUR PRICE \$1.55

2-WAY LAMP

Ornamental dual purpose lamp. Can be used as a table or vanity lamp in one position. By turning swivel base it becomes a bracket lamp which may be mounted on wall.



Ornamental dual purpose lamp. Can be used as a table or vanity lamp in one position. By turning swivel base it becomes a bracket lamp which may be mounted on wall. Hanger in base is provided for this. Handsome design. Base made of pressed glass, polished wood and plated metal stand. Comes with round shade colorfully decorated with ribbon design, or more elaborate fluted shade with flower design. Height of lamp 12 1/2"; shade 8". Complete with cord. Shipping wt. 2 lbs.



ITEM (Plain Shade) NO. 120
 YOUR PRICE 98c
 ITEM (Fluted Shade) No. 121. YOUR PRICE \$1.05

BENNETT LABORATORY BALANCE

A compact laboratory balance made of finest quality tested materials. Extreme sensitivity (to 2-100ths gram or 2-7ths grain). Weighs to one decimal Pt. further

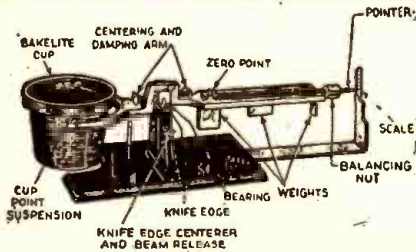

than usual low priced counter scale. Will handle up to 100 grams (about 4 oz.). Bakelite pan; tool steel knife edge; acute bearing for long life and accuracy. Ideal for photographic work and lab use. Handsome streamline design. Graduated either in metric or apothecary system. Shipping wt. 2 lbs.

ITEM NO. 122
 YOUR PRICE \$7.20

100 POWER TELESCOPE LENS KIT

Make your own high powered 6 ft. telescope. Now you can thrill to a close-up view of the worlds out in space. See the rings around Saturn, the mountains of the moon! Kit contains 3" diam., 75" focal length, ground and polished objective lens and 2 astronomical eye-pieces, magnification 50x and 100x. Complete kit with full instructions.

ITEM NO. 123
 YOUR PRICE \$1.95

New Catalog

JUST OUT
A POSTAL CARD BRINGS IT TO YOU
SEND FOR IT TODAY

HUDSON SPECIALTIES CO., 40 West Broadway, N. Y. C.

IT'S EASY TO ORDER—CLIP COUPON—MAIL NOW ORDER FROM THIS PAGE.

HUDSON SPECIALTIES CO., 40 West Broadway, Dept. RC-441, New York, N. Y.

I have circled below the numbers of the items I'm ordering. My full remittance of \$..... (Include shipping charges) is enclosed.

OR my deposit of \$..... is enclosed (20% required), ship order C.O.D. for balance. No C.O.D. order for less than \$2.00. (New U. S. stamps, check or money order accepted.)

Circle Item No. wanted: 11, 86, 87, 97, 120, 121, 122, 123, 124, 125

Name Address

City State

Send remittance by check, stamps or money order; register letter if you send cash or stamps.

AMAZING BLACK LIGHT!!

Powerful 300-Watt Ultra-Violet Bulb



The best and most practical source of ultra-violet light for general experimental and entertainment use. Makes all fluorescent substances brilliantly luminescent. No transformers of any kind needed. Fits any standard lamp socket. Made with special filter glass permitting only ultra-violet rays to come through. Brings out beautiful opalescent hues in various types of materials. Swell for amateur parties, plays, etc., to obtain unique lighting effects. Bulb only. Size of bulb. Shp. Wt. 1 lb.

ITEM NO. 87
 YOUR PRICE \$2.00

ULTRA MAGNET

LIFTS MORE THAN 20 TIMES ITS OWN WEIGHT

LITTLE GIANT MAGNET. Lifts 5 lbs. easily. Weighs 4 oz. Made of ALNICO new high-magnetic steel. Complete with keeper. World's most powerful magnet ever made. The experimenter and hobbyist will find hundreds of excellent uses for this high quality permanent magnet. Measures 1 1/2" x 1 1/2". Shp. Wt. 3/4 lbs.



ITEM NO. 86
 YOUR PRICE \$1.00

ELECTRIC TURNTABLE



A sturdy electric turntable. Ideal for eye-catching window displays. A MUST for alert retailers. Frame made of 16 gauge steel, 16 in. steel turntable makes three revolutions per minute. Turntable supports load of 200 lbs. Ballbearing construction. Rich black enamel finish. Operates on 110 v. A.C. Current cost only 1/4c a day. Size: 5 1/4" high, base 8" square. Shipping wt. 14 lbs.

ITEM NO. 124
 YOUR PRICE \$8.95

NEW ELECTRIC MOTOR-SAW

Now you can have all the fun of fine, fast jig saw work without any of its difficulty. Simply steer the lightning-fast blade and see it seemingly melt its magic way through wood, plastics and building board. 7200 STROKES per MINUTE! Average cutting speed 1 foot per minute through 3/4" medium hard wood. Works 3 times faster than any free-hand saw. Operates on 50-60 cycle 110 v. Alternating Current. Screw adjusts blade stroke from 1/4" to 5/16". Off-On Switch built in handle. Complete with 6 ft. power cord and 3 saw blades.

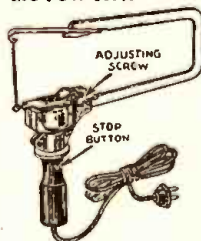

ITEM NO. 97
 YOUR PRICE \$4.85

ELECTRIC HUMIDIFIER FOUNTAIN



Adds healthful moisture to the air in winter. Evaporates as much as a pint of water in 24 hours. Fountain is 14" in diam. Sprays 8 streams of water 5" above fountain head. Made of spun aluminum. Comes in five colors: Bronze, chrome, copper, red, green. No water connections required. Just plug into 110 volt, 60 cycle

A.C. outlet. Current consumption few cents a month. Complete with base switch and 8 ft. power cord. Shipping wt. 9 lbs. List price \$14.95. Only a limited supply on hand.

ITEM NO. 125
 YOUR PRICE \$4.95

nection, the following is quoted from the annex to the Inter-American Radiocommunications Arrangement:

"All diathermy machines designed for the same service can operate on the same frequency without impairing their usefulness, since their operation is not affected by radiation from other machines. Operation on a specific frequency with a very close frequency tolerance is practicable, with little added cost. It is understood that the present design of diathermy equipment has to a great extent gravitated to frequencies above approximately 12 megacycles, hence it is recommended that the subscribing countries consider requiring all diathermy machines to use not more than 2 frequencies in harmonic relation above 12 megacycles which will not interfere with existing radio assignments. The harmonic relationship between the 2 frequencies provides a further guarantee against interference to radio communication.

"Standards of good engineering practice are believed to be practicable at the present time and consideration of the adoption by the governments of such standards at the earliest practicable date is recommended. The standards should include the following subjects:

- (a) Frequencies to be used.
- (b) Automatic frequency control.
- (c) Frequency stability.
- (d) Type of emission.
- (e) Maximum power output.
- (f) Harmonic radiation to be effectively suppressed.
- (g) Internal circuits to be effectively shielded.
- (h) Radiation from power supply connection to be eliminated.

"Where diathermy apparatus does not comply with the standards which may be adopted by the subscribing countries they should consider the desirability of requiring such apparatus to be operated in a properly shielded room."

There has been splendid cooperation among all concerned—the manufacturers of the apparatus, the medical profession, the Government, and commercial agencies whose radio services are affected, and the general public. When the medical profession has agreed on the most effective region of the radio spectrum for diathermy treatments, it will be the first task of the Commission to find a suitable frequency for diathermy operation. The provisions which must then be met insofar as the apparatus is concerned, should be arrived at by cooperative efforts on the part of the Government and other interested parties. The Federal Communications Commission stands ready to assist, and is planning to call a conference for this purpose in the near future.

WARNING!

Unless you reserve your copy of the May issue of RADIO-CRAFT NOW, your dealer may be all sold out. This is because the May issue is going to be a special one on SOUND.

In addition to the usual material, this issue will contain special theoretical and constructional articles on Home Recording, Phono-Radio Combinations, Public Address, Amplifiers, etc. It is going to be an important issue for Sound Specialists, radio Servicemen and radio men in general.

Sound is booming!... so RADIO-CRAFT is going to town! RESERVE YOUR MAY ISSUE NOW.

WEIGHT SCALE FOR RECORDERS

Universal Microphone Co.
424 Warren Lane, Inglewood, Calif.



NO larger than the size of an ordinary fountain pen, this scale very quickly, conveniently and accurately measures the weight of any recording head. It is a handy unit to have around since various recorder manufacturers recommend their own weight limitations on pickups and cutting heads. Proper cutting head weight controls depth of cut.—*Radio-Craft*

LABORATORY OSCILLOSCOPE

Allen B. Du Mont Laboratories, Inc.
Passaic, New Jersey

HERE are the features of the new type 208 Du Mont cathode-ray oscilloscope: Accelerating potential—1,500 volts; 4 easily-accessible deflection-plate terminals; beam switch; removable, calibrated scale for qualitative and quantitative measurements; extended sweep-frequency range—2 to 50,000 cycles; improved amplifier circuits giving symmetrical position-control and deflection potentials; amplifiers flat—2 to 100,000 sinusoidal cycles per second; 4-cycle square-wave response; voltage gain of 2,000 times.

Instantaneous position circuits—no "electrical backlash"; new power-transformer design—negligible magnetic distortion; magnetically-shielded cathode-ray tube; nearly 15-inch time base, with over 2½ times full-scale deflection; freedom from pattern drift; regulated amplifier-power-supply; regulated position-voltage power-supply; new, functionally-designed front panel; compact—small size.—*Radio-Craft*

VOLUME-LEVEL INDICATOR

General Electric Co.
Schenectady, N. Y.

MODEL DO-61 is a VU volume-level indicator which essentially is a low-range, rectifier-type, r.m.s. voltmeter consisting of a d'Arsonval element with an alnico magnet, in series with a stable, full-wave, copper-oxide rectifier designed for performance under wide variations of frequency. The instrument has 2 sets of scale marking, namely -20 to 0 to +3 VU, and the other, 0-100% volts.—*Radio-Craft*

NEW COMMUNICATIONS RECEIVER

National Co., Inc.
Malden, Mass.

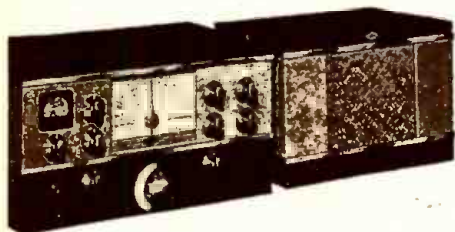

THE new NC-200 Communications Receiver is a 12-tube superhet, covering 10 accurately-calibrated ranges. Six of these are of the general coverage type tuning continuously from 490 to 30,000 kc. The remaining 4 are band-spread ranges for the amateur 10, 20, 40 and 80 meter bands. Other features include single-dial tuning control, temperature compensation, automatic voltage stabilization, series valve noise limiter, and flexible crystal filter.—*Radio-Craft*

NEW 6-8 WATT AMPLIFIER

Lafayette Radio Corporation
100 6th Ave., N. Y. C.

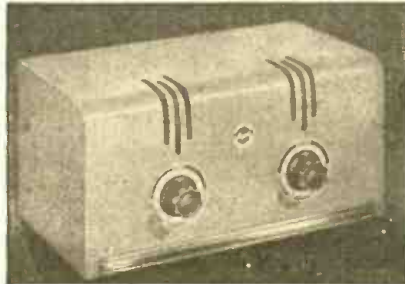

THE Model 406-T amplifier delivers 6 watts continuous and 8 watts on peaks. One microphone and one phono channel are provided with gain of 105 and 62 db. respectively. Frequency response is 50 to 8,000 c.p.s. but a tone control is provided to adapt the output to the acoustic requirements of each location. Size 6½x9x7 ins. deep.—*Radio-Craft*

MARINE RECEIVER & DIRECTION FINDER

Jefferson-Travis Radio Mfg. Corp.
198 Milburn Avenue, Baldwin, N. Y.

THE basic unit of this equipment consists of a compact 3-band marine radio receiver which by the addition of the plug-in loop antenna with compass scale can also operate as a direction finder. The receiver is of the superhet. type mounted in a weatherproof metal cabinet measuring 6x9x8 ins. deep. The tuning range covers 3 bands important to boat owners, namely Marine Radio Beacon Range (200-400 kc.), Standard Broadcast Band (550-1,500 kc.), and Marine Radiotelephone Range (2,000-3,000 kc.).—*Radio-Craft*

INTERCOMMUNICATION SYSTEM

Webster-Chicago Corp.
5622 Bloomingdale Ave., Chicago, Ill.

MODEL W-102 is a 2-station system for use in business and other offices where instant intercommunication is desired. Among its features are latest-type tubes, balanced line, freedom from hum, and new compact loudspeaker - microphone. The system comprises one master station and one remote station. When the master station calls the remote station, the latter can answer back without operating any controls. The master station is equipped with a volume control on the front panel.—*Radio-Craft*

REFLEX SPEAKER

University Laboratories
195 Chrystie St., N. Y. C.

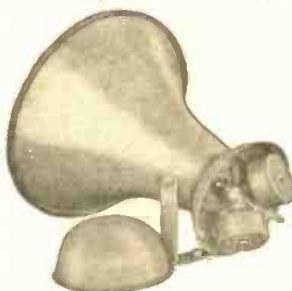

MODEL 2YR is a high-power "Baby Bull" reflex speaker designed for 60 watts continuous audio input. The speaker is made completely non-resonant by the use

of a rubber tire rim. Driver units consist of two 25-watt high-efficiency units. The units are acoustically connected by means of a "Y" line into the horn which is designed to give uniform loading to the driver combination. Bell diameter 24 ins., impedance 8 or 30 ohms.—*Radio-Craft*

PLUG-IN ELECTROLYTICS

Aerovox Corporation
New Bedford, Mass.

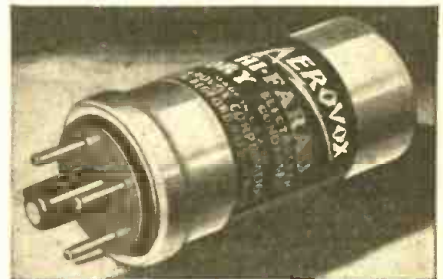

ORIGINALLY made to order for military, aircraft, police radio, and other special uses, these plug-in electrolytics are now available as standard equipment from various jobbers.

The bases are constructed to fit standard octal sockets and the units are available in standard capacities.—*Radio-Craft*

POLICE POCKET RECEIVER

Tay Bern Equipment Co., Inc.
135 Liberty St., New York City

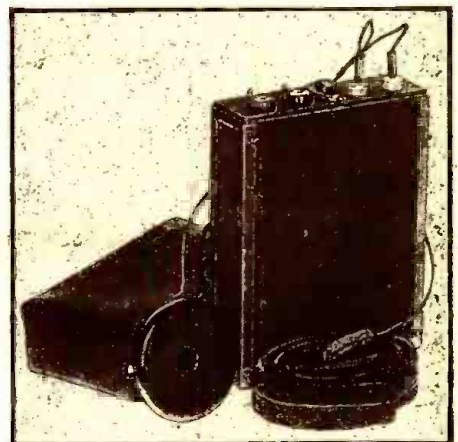

A MINIATURE 4-tube superheterodyne receiver for pocket or belt wear. Designed especially for patrolmen, but has many other applications where single-way reliable communication is desired. Range of reception up to 500 miles, depending on transmitter and location. Photograph shows shoulder-strap antenna, lightweight phone (miniature hearing-aid phone may be substituted) for head wearing or shoulder strap mounting, and battery pouch which is designed for belt mounting or pocket concealment. Tuning is pre-set at desired frequency (any one from 1,550 kc. to 6.5 megacycles), and because of permeability-tuned circuits drifting and readjusting is eliminated.—*Radio-Craft*

F.M.-A.M. TUNER

The Hallicrafters
2611 S. Indiana, Chicago, Ill.

THE Model S-31 F.M.-A.M. Tuner provides full facilities for F.M. and for standard broadcast response of unusual quality without the necessity for duplication of audio equipment. Its undistorted output of 130 milliwatts is ample for any standard amplifier, including those in existing broadcast

• LATEST RADIO APPARATUS •

OPPORTUNITY AD-LETS

Advertisements in this section cost 15 cents a word for each insertion. Name, address and initials must be included at the above rate. Cash should accompany all classified advertisements unless placed by an accredited advertising agency. No advertisement for less than ten words accepted. Ten percent discount six issues, twenty percent for twelve issues. Objectionable or misleading advertisements not accepted. Advertisements for May, 1941, issue must reach us not later than March 7th.

Radio-Craft • 20 Vesey St. • New York, N. Y.

BOOKS AND MAGAZINES

ASSURE YOURSELF OF GREATER PROFITS BY doing radio service jobs more quickly. Authentic service guides show you the way to locate and correct troubles in any radio receiver. Gernback Official Radio Service Manuals show you how to complete more repair jobs in less time—how to earn more money by faster servicing. Radio-Craft Publications, 20 Vesey St., New York City.

WE HAVE A FEW HUNDRED RADIO ENCYCLOPEDIAS, by S. Gernsback, second edition, originally sold at \$3.98. Book has 352 pages, weight 3 lbs., size 9 x 12 inches. Red morocco—keratol flexible binding. Send \$2.49 in stamps, cash or money order and book will be forwarded express collect. Technifax, 1915 So. State Street, Chicago, Illinois.

WHAT DO YOU KNOW ABOUT AMPLIFIERS AND Sound Systems? The Amplifier Handbook and Public Address Guide covers P.A. from A to Z. Most complete and authentic book published on the subject. Contains 80 pages of vital information on Amplifiers, P.A. Systems, Speakers, Accessories, Pickups, Microphones, etc. Printed on fine coated stock, with numerous photographic illustrations and explanatory diagrams, and only 25c. See Page 614.

EDUCATIONAL COURSES

CORRESPONDENCE COURSES AND EDUCATIONAL books, slightly used. Sold, Rented, Exchanged. All subjects. Satisfaction guaranteed. Cash paid for used courses. Complete details and bargain catalog FREE. Write Nelson Company, 500 Sherman, Dept. D-242, Chicago.

MANUSCRIPTS WANTED

WANTED—MANUSCRIPTS, POEMS, SONGS FOR publication. Fortune's, 87 Fifth Ave., New York.

MOTION PICTURES

GENERAL FILMS FOR MOVIE CAMERAS. SAVE 50%. Get two films "The End," 10c. (Size 7) Big Bargain Circulars. Fromaders, Davenport, Iowa.

PHOTOGRAPHY

1/100,000 OF A SECOND SPEED FLASH UNIT FOR Stroboscopic Photography. \$200.00. Apt. 63, 782 West End Ave., New York City.

RADIO

SACRIFICE! 12-TUBE LINCOLN SUPER-DELUXE All-Wave Receiver, complete with 12-inch electrodynamic speaker and separate power pack. Cost originally \$345. Will sacrifice for \$25.00. Set is 1933 model, rarely used and in good working condition. Excellent sensitivity and selectivity. A resonance tuning meter, wave-band switch, phonograph input terminals, an ideal set for the DX fan. Excellent tonal fidelity. All components mounted on a beautiful chromium-finished chassis. Rush! First come, first served! D. Kreissman, 1430 Ocean Ave., Brooklyn, N. Y.

WE BUY AND SELL USED RADIO TESTING EQUIP- ment. Time payments if desired. Harold Davis, Inc., Jackson, Miss.

QUESTION? ABOUT RADIO? WRITE WILLIAM D. Hayes, Box 1433-J, Oakland, California.

SWAP RADIO SETS, METERS, CAMERAS, ETC., FOR: old Tusk "Supordyne," electrolytic detector, "Grant" loudspeaker, Adams-Morgan wooden-case brass-plate variable condenser, 1" or 2" spark coil; and other radio components dating prior to 1920. R. Bernard, 40 Mantua Ave., No. Plainfield, N. J.

RADIO KITS

RADIO KITS—\$3.95 UP. SINGLE BAND; ALL WAVE. 5-10 tubes. Fluorescent lighting. Save 50%. McGeo Radio, P-2055, K.C., Mo.

SOUND

SELL: MULTICHANNEL AMPLIFIER, SPEAKERS, microphones, motor, pickup, cases, cabinet. Beggs, 5321 Wayne Avenue, Phila., Penna.

TECHNICAL ART SERVICE

DRAFTING AND ART SERVICE—A COMPLETE Service for the Industrial and Commercial Marketers. If your business or plant can't afford a designer or drafting staff, don't let this stop you from going ahead with that new product you intend marketing, or that catalog of mechanical or electrical items which needs fine detailed drawings and highly retouched photographs. Any mechanical, electrical or radio problem can be solved for you by our associated staff of designers, draftsmen and artists, and technical copywriters. Write for any additional information as to methods and price for this service. Tec-Art Drafting Service, 228 Charlotte Terrace, Roselle Park, N. J.

DRAFTING SCHEMATIC DIAGRAMS SEND US A rough sketch of your circuit. Estimates by return mail. Our prices are moderate; our work guaranteed. No jobs too big or small. Wm. Kadlecck, Jr., 440 East 85th St., New York, N. Y.

receivers. Its features include 2 tuning ranges, viz., 540 to 1,650 kc. and 40-51 mc.; dual I.F. system, phono input, radio - phono switch, "S"-meter adjustment, outputs of 500 and 5,000 ohms, and a headphone jack for monitoring purposes. The panel is of the standard rack-mounting type measuring 19x8 3/4 ins.—Radio-Craft

TABLE LAMP RADIO

Mitchell Manufacturing Co.
Chicago, Ill.

THE "Lumitone" is a beautifully-designed table-lamp radio which contains a 5-tube A.C.-D.C. receiver in its base. A built-in loop antenna eliminates the necessity of hanging wires. Sound from the electro-dynamic speaker comes out of a louvered top of the lamp body. Size 21 1/2 x 6 1/4 x 6 ins., diameter, 5 1/2 ins. A 3-way lamp switch provides lighting of either 50, 100 or 150-watts.—Radio-Craft

NEW RECORDING NEEDLE

Howard Radio Co.
Chicago, Ill.



A NEW long-life recording needle having a Permo metal tip of unusual hardness makes possible more than 200 6 1/2-in. recordings with good fidelity.—Radio-Craft

PORTABLE P.A. SYSTEM

Erwood Sound Equipment Co.
223 W. Erie St., Chicago, Ill.

A COMPLETE 28-watt portable P.A. system housed in a case designed to carry in addition, 2 full-length floor-type microphone stands with mikes. A record-playing attachment is also included in the case assembly. The loudspeakers are contained in a rear-cut type of cabinet which eliminates rear radiation.—Radio-Craft

NEW RADIO TUBE LINE

Allied Radio Corp.
833 W. Jackson Blvd., Chicago, Ill.



A NEW line of Knight radio tubes has just been announced. The tubes carry a replacement guarantee covering any electrical or mechanical defect for a period of 6 months from the date of purchase. They are RCA licensed and incorporate the latest developments in vacuum tube design and characteristics. They are available in a wide selection of latest types in all-glass, all-metal, octal base glass, miniature, and GT octal base types.—Radio-Craft

FLUORESCENT LIGHTING ADAPTORS

Eagle Electric Mfg. Co.
59-79 Hall St., Brooklyn, New York



A NEW line of "Fluralamp" adaptors designed to permit fluorescent lighting fixtures to be used in standard outlets. It is merely necessary to screw these fixtures into the existing sockets. Illustrated is a 24-inch duplex unit complete with swivel plug. It uses 2-24 inch fluorescent bulbs, each rated at 20 watts. Designed for 110-120 V., 60 cycles, A.C. only.—Radio-Craft

SQUARE-WAVE GENERATOR

General Electric Co.
Schenectady, N. Y.

IN this square-wave generator, great flexibility is provided by an adjustable pulse width (10 or 50%, with vernier for exact adjustment to these values) and a variable frequency (10 overlapping bands between 1.5 and 250,000 cycles per second). Added versatility is provided by controls for

Social Security name Plate

Only 35¢

Bronze Plate with your Name & Number on it and This GENUINE LEATHER BILLFOLD without Extra Charge.

For the nominal amount of 35c we will send you the following values:

- One dual-tone imperishably etched Bronze Name Plate, size 2 1/2 inches with your Social Security number and name permanently stamped upon it.
- One Genuine Leather Billfold, size 8 1/2 x 9 inches in natural brown color, with four compartments, as per illustration above.

This Pocketbook is our free present to you. Absolutely no strings of any kind. We make you this gift because we expect you to do us a favor by showing your name plate to your friends, to interest them in ordering one for themselves. That's all. Help us and you will profit yourself.

ACT NOW! Mail the coupon below and enclose 35c in Billfold will be forwarded to you at once.

PREMIUM DISTRIBUTING SERVICE
Wrigley Bldg., Chicago, Dept. RC-441

Enclosed find 35c for which mail to the address below, my Social Security Bronze Plate and the Genuine Leather Billfold without extra cost, as per your offer.

My Social Security Number is

NAME

ADDRESS

CITY

STATE

fine or coarse frequency adjustments and for synchronizing-voltage adjustments. Synchronization with standard and other external frequencies is possible. A square-wave generator can be an extremely useful tool in many branches of the communication field such as F.M. and A.M. broadcasting, telephone and telegraph communication, manufacturing of radio equipment, etc. Testing by means of the square-wave is extremely simple, requiring in addition only an oscilloscope.—Radio-Craft

GENERATOR FIELD RHEOSTATS

Ohmite Mfg. Co.
4848 W. Flournoy St., Chicago, Ill.

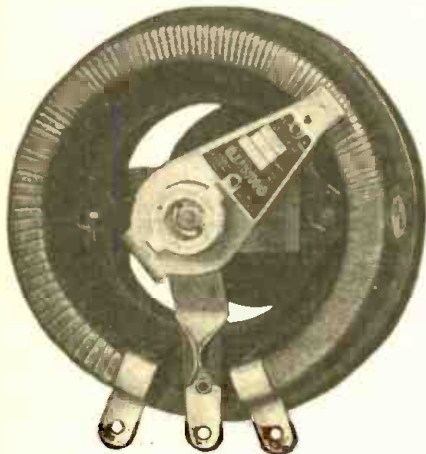

THESE field rheostats are tapered or uniformly wound, as required. Designed to provide control for separately or self-excited generators. They are available in a series of 10 watt sizes, from 25 to 1,000 watts. Thus, there is an Ohmite Field Rheostat suitable for every size generator—from the smallest to units of several kilowatts. By connecting rheostats in tandem, this range can be extended further.—Radio-Craft

"CHEST RADIO"

Sentinel Radio Corp.
Evanston, Ill.

SOMETHING new and novel in a radio set which is hardly larger than a jewel box, and looks very much like one. It is a personal radio of the miniature type which operates entirely from batteries. Has built-in aerial, miniature tubes, automatic volume control, and other features. Size 9½ x 4½ x 5 ins. deep.—Radio-Craft

AUTOMATIC RELAY FOR A.C.-D.C. BATTERY SETS

Amperite Company
561 Broadway, New York, N. Y.

THIS relay, when installed in 3-way receivers, automatically changes the operation from batteries to the A.C.-D.C. line. The relay consists of 2 single-pole contacts which are placed in the "A-" and "B-" battery lead. As soon as A.C. or D.C. passes through the set, the relay automatically starts its operation. Thus, it is impossible to forget to switch or change the set to A.C.-D.C. operation, which, without the relay, would mean that the set would be operating from batteries despite the fact that the line cord is plugged into an outlet.—Radio-Craft

2-WAY PORTABLE RADIO

Lear Avia, Inc.
Dayton, Ohio

DESIGNED for military and general commercial use, this 2-way portable radio set, compact and rugged, operates in the

3,000-6,000 kc. band. Known as model TRM-204, this 2-way unit comprises a small 10-watt transmitter and a companion receiver, both in a single carrying case. The power supply for both transmitter and receiver, a dynamotor, is in the bottom of the carrying case which measures 12x6¼x12¼ ins. deep. Weight of entire unit, including accessories but less the storage battery, is 20 lbs.—Radio-Craft

NEW LOUDSPEAKER HORNS

RCA Mfg. Co.
Camden, N. J.

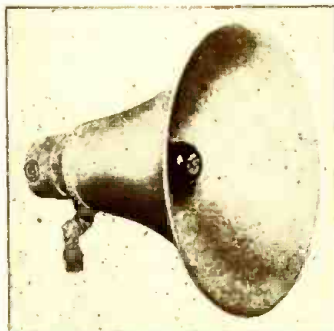

JUST introduced are 2 new metal re-entrant loudspeaker trumpets and 3 new speaker mechanisms providing a variety of power. They are designed primarily for providing high-quality sound over large areas with good directional characteristics. Illustrated is the smaller of the two, the MI-6302, a 3½ foot baffle compressed into 19 inches. Bell diameter is 21½ ins., frequency response, 200 to 7,000 cycles. Three loudspeaker assemblies, providing 15-, 12- and 10-watt power are interchangeable with both horns.—Radio-Craft

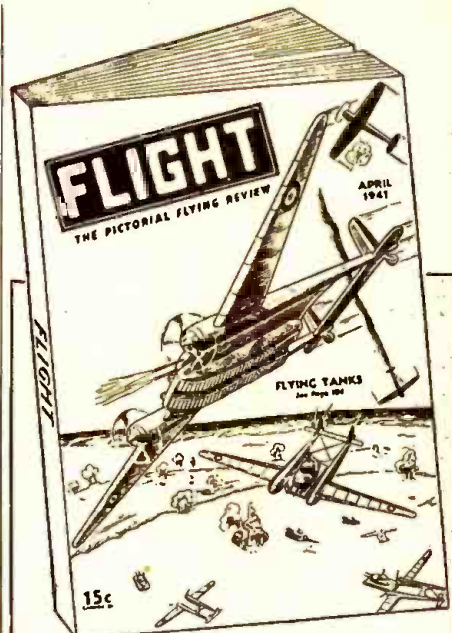

FLIGHT THE PICTORIAL FLYING REVIEW

Brings you all the phases of world aviation and aeronautics in a non-technical yet educational manner—exciting articles which catch your breath, yet give you the fundamentals of flying and ALL related subjects. FLIGHT keeps you abreast of all the major developments as fast as they appear anywhere. Now, when planes and flying are of vital importance to all, you just can't do without this highly absorbing yet instructive publication. You must be "in the know."

Partial Contents of the April Issue: The Flying Tank, Hufo Gernsback, The R.A.F. Wellington Bomber—with Sectional Views, Question Box, How Anti-Aircraft Predictors Work, Full Details of the Famous "Hurricane" Fighter, How English Fight Mass Bombing Attacks by Nazis, New Aerial Tactics, Airplane Cannon vs. Machine Guns, The New Nazi "Bombers" and "Fighters."

attractive three-color cover, numerous illustrations. **15¢** copy

Subscription price \$1.50 a year, Canada and foreign \$2.00.

FLIGHT MAGAZINE, 20-R Vesey St., New York, N. Y.

Get This Electric Dry Shaver
ABSOLUTELY FREE!

JUST THINK OF IT—you can get absolutely FREE, the useful DRY ELECTRIC SHAVER which is shown at the left. This ELECTRIC DRY SHAVER is sent to you by the publishers with a one-year subscription to RADIO-CRAFT.

Here Are the Features of The ELECTRIC DRY SHAVER

Constructed of metal with attractive red bronze finish. Scientifically constructed to give a perfectly clean shave. 5-foot rubber insulated cord and plug. Constructed to last for many years.

Operates from 110-volt, 60-cycle A.C. electric line. Carries a two-year manufacturer's guarantee. A fine quality, self-sharpening toilet necessity.

Send your subscription to RADIO-CRAFT for One Year (12 issues) and receive absolutely FREE one of these remarkable Electric Dry Shavers. New subscribers are accepted or you may extend your present subscription another twelve months. Mail your remittance of \$2.00 (plus 25c for shipping charges on Shaver) to the publishers. (Canada and foreign \$2.75.) You will receive your DRY ELECTRIC SHAVER immediately by return mail. Use coupon below to enter your subscription.

RADIO-CRAFT
20 Vesey Street, New York, N. Y.

RADIO-CRAFT, 20 Vesey Street, New York, N. Y.

Gentlemen: Enclosed find my remittance of \$2.00 for which enter my subscription to RADIO-CRAFT for one year (12 issues). Send me immediately FREE ELECTRIC DRY SHAVER (Canada and foreign \$2.75). In U. S. add only 25c additional to cover shipping charges on Shaver.

New Subscriber Extend Present Subscription

Name

Address

City State

(Send remittance by check, money order or unused U.S. Postage Stamps. Register letter if you send cash or stamps.) RC-441

LATEST RADIO APPARATUS

DYNAMIC MICROPHONE

American Microphone Co.
1915 S. Western Ave., Chicago, Ill.



THE VR-2 unit has an easily accessible external adjustment of the most important acoustical reactors in this dynamic microphone. A smooth change from a communications-type response, with a cutoff below 500 c.p.s., through a flat response to an augmented bass, is attained by a simple positive adjustment. Greatest diameter of mike is 3 ins.; net weight, 15 ozs. Available in various impedances.—Radio-Craft

PORTABLE RECORD PLAYER AND AMPLIFIER

Autocret Radio Co.
3855 N. Hamilton Ave., Chicago, Ill.

AN electric phonograph complete with built-in amplifier and electric turntable. The motor is a heavy self-starting unit of the 60-cycle induction type operating at a speed of 78 r.p.m. The instrument uses a high-fidelity crystal pickup, 8-in. P.M. dynamic speaker, and beam power amplifier. All equipment is in a single portable case having provisions in the lid for carrying several records. It is known as model EPP-11. Size 16x14x8½ ins., and weighs 16 lbs., approx.—Radio-Craft

VICTROLA HOME RECORDER

RCA Mfg. Co.
Camden, N. J.



MODEL V-101 is a 5-tube (plus rectifier tube and ballast) instrument with an audio system especially designed for reproducing records. It delivers 5-watts of power through an efficient 6-inch electrodynamic speaker. Has built-in "Magic loop antenna" for radio reception. Plays 10- or 12-inch records with the lid closed. Other features include crystal pickup, 2-point tone control, and superhet. circuit using magnetite-core I.F. transformers. Measures 12¼x18¼x13½ ins. deep.—Radio-Craft

NEW LOOP ANTENNA

RCA Aviation Radio
Camden, N. J.

A NEW aviation loop antenna and adaptor kit designed especially as an aural-null direction finding attachment for RCA model

AVR-7D, E, F, G, and H Aircraft Receivers. The loop is available in either remote or local control forms and will operate as a direction finder on the Beacon band (195-420 kc.) or on the Beacon and Broadcast bands (195-420, and 459-1,400 kc.).—Radio-Craft

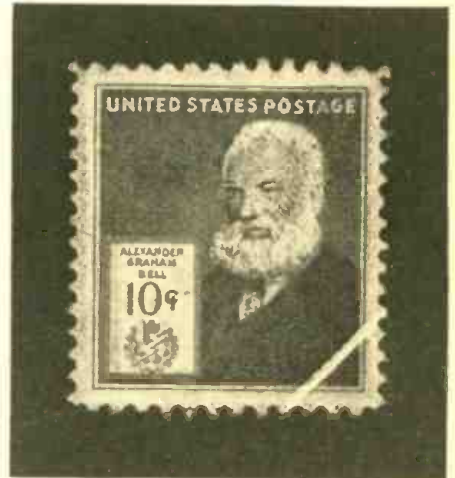

ALEXANDER GRAHAM BELL STAMP

Newest in stamps available to collectors through the Philatelic Agency, Post Office Department, Washington, D. C., and of special interest to technicians, are those in the Inventors series issued last month. Illustrated here is the 10c stamp dedicated to Alexander Graham Bell. The remaining inventors similarly honored are: Whitney, 1c; Morse, 2c; McCormick, 3c; Howe, 5c.

We're Not Fooling, Mr. Serviceman!

➔ NATIONAL DUES IN THE RSA ➔ ARE ACTUALLY ONLY \$1.00 A YEAR



Yes—it seemed amazing . . . incredible . . . but Servicemen found it was true. Now hundreds of applications are pouring in from all parts of the country! Just think—a full year membership in the National RSA for only \$1.00 (that's less than 2c a week).

You get the RSA Membership Certificate and the RSA House Organ. You have access to RSA Technical Help Bureau, and you can participate in all the other functions and benefits RSA offers.

It's your big chance to join with thousands of your fellow Servicemen in this great national organization and have a voice in your own destiny. It's your big chance to help yourself get ahead in your industry.

Protected territories will be established as rapidly as local chapters are formed. Applicants in present chapter areas will be referred to the local chapter.

Fill out the coupon, attach a \$1.00 bill and mail it in today.

RADIO SERVICEMEN OF AMERICA, INC.

"Reliable Service Assured"

JOE MARTY, JR., EXECUTIVE SECRETARY
304 S. DEARBORN ST., CHICAGO, ILLINOIS

RADIO SERVICEMEN OF AMERICA, INC.
304 S. Dearborn Street, Chicago, Illinois

\$1.00 enclosed for 1941 National Dues in RSA.

Name

Address

City State

Radio-Craft—April

Where to Buy It! —

CLASSIFIED RADIO DIRECTORY

Handy Buying Guide, by Products and Manufacturers' Names and Addresses, for the Entire Radio Industry

There is no charge for regular light-face listings in the Classified Radio Directory. However, if dominant bold-face listings are desired, we make a charge of \$2 for concern names and \$1 for trade names for each bold-face listing. Please write to the Advertising Dept., Radio-Craft, 20 Vesey St., New York, N. Y., for details.

This DIRECTORY is published in sections—1 section per month. This method of publication permits the DIRECTORY to be constantly up-to-date since necessary revisions and corrections can be made monthly. All names preceded by an asterisk (*) indicate that they are trade names.

If you cannot find any item or manufacturer in this section or in previously-published sections, just drop us a line for the information.

Presented here is Section I of the completely revised Second Edition of the CLASSIFIED RADIO DIRECTORY.

While every precaution is taken to insure accuracy, Radio-Craft cannot guarantee against the possibility of occasional errors and omissions in the preparation of this Classified Directory. Manufacturers and readers are urged to report all errors and omissions at the earliest moment to insure corrections in the very next issue.

AMPLIFIERS



- Amplifier foundation units A
- Direct-coupled D
- Hearing-aid H
- Hearing-aid audio components HC
- Kits (amplifier) KI
- Mobile MO
- Power PO
- Preamplifiers PR
- Recorders and recording equipment (see Recording Equipment)
- Sound motion picture S
- Transmitter T

- *"AIRLINE"—Montgomery Ward & Co.
- ALLIED RADIO CORP.**, 833 W. Jackson Blvd., Chicago, Ill., *"Knight"—KI, PO, PR
- AMERICAN TRANSFORMER CO.**, 178 Emmet St., Newark, N. J., *Amertran—KI
- AMPERITE COMPANY**, 561 Broadway, New York, N. Y.—PR
- AMPLIFIER CO. OF AMERICA**, 17 W. 20th St., New York, N. Y.—A, D, H, HC, KI, MO, PO, PR, S, T
- AUDIO DEVELOPMENT CO.**, 123 Bryant Ave., N., Minneapolis, Minn.—PO, PR
- AUDIOGRAPH SOUND SYSTEMS**, 1313 W. Randolph St., Chicago, Ill.—PO, PR
- BANK'S MANUFACTURING CO.**, 5019 N. Winthrop Ave., Chicago, Ill.—PO, PR
- BARKER & WILLIAMSON**, Ardmore, Pa.—PO, PR
- BUD RADIO, INC.**, 5205 Cedar Ave., Cleveland, Ohio—KI
- CANADIAN MARCONI CO.**, 211 St. Sacramento St., Montreal, Que., Can.—PO, PR
- CHICAGO SOUND SYSTEMS CO.**, 315 E. Grand Ave., Chicago, Ill.—KI, PO, PR
- CINEMA ENGINEERING CO.**, 1508 W. Verdugo Ave., Burbank, Calif.—PO, PR
- CRUMPACKER DISTRIB. CORP.**, 1801 Fannin St., Houston, Tex.—PO, PR
- HAROLD DAVIS, INC.**, 428 W. Capitol St., Jackson, Miss.—PO, PR
- DE VRY CORPORATION**, 1111 Armitage Ave., Chicago, Ill.—PO, PR
- DOW RADIO SUPPLY CO.**, 1759 E. Colorado St., Pasadena, Calif.—KI, PO
- ELECTRONIC APPLICATIONS**, Brunswick, Me.—PO, PR
- ELECTRONIC SOUND & MUSIC CO.**, 10 Stuyvesant St., New York, N. Y.—PR
- ERWOOD SOUND EQUIPMENT CO.**, 224 W. Huron St., Chicago, Ill.—PO, PR
- FINCH TELECOMMUNICATIONS, INC.**, 1819 Broadway, New York, N. Y.—PO, PR
- FISCHER DISTRIB. CORP.**, 222 Fulton St., New York, N. Y.—KI, PO, PR
- THE JOHN GABLE MFG. CO.**, 1200 W. Lake St., Chicago, Ill.—PO
- GENERAL COMMUNICATION PRODUCTS CO.**, Lexington Ave. at Vine, Hollywood, Calif.—PO, PR
- GUIDED RADIO CORP.**, 118 E. 25th St., New York, N. Y.—PO, PR
- THE HALLDORSON COMPANY**, 4500 Ravenswood Ave., Chicago, Ill.—KI
- HAMMOND MANUFACTURING CO.**, Guelph, Ont., Can.—KI
- HARRISON RADIO CO.**, 12 W. Broadway, New York, N. Y.—KI, PO, PR

- HARVEY-WELLS COMMUNICATIONS, INC.**, North St., Southbridge, Mass.—PO, T
- CHARLES JACK MFG. CORP.**, 27 E. Philadelphia St., York, Pa.—PO, PR
- ***KNIGHT—Allied Radio Corp.**
- LAFAYETTE RADIO CORP.**, 100 6th Ave., New York, N. Y.—PO, PR
- LAUREHK RADIO MFG. CO.**, 3918 Monroe Ave., Wayne, Mich.—PO
- LEOTONE RADIO CO.**, 63 Dey St., New York, N. Y.—PO, PR
- THE LINCROPHONE CO., INC.**, 1661 Howard Ave., Utica, N. Y.—PO, PR
- M & H SPORTING GOODS CO.**, 512 Market St., Phila., Pa.—KI, PO
- MARINE RADIO CORP.**, 117-17 168th St., Jamaica, N. Y.—PO, PR
- MILES REPRODUCER CO., INC.**, 812 Broadway, New York, N. Y.—KI, PO, PR
- MONTGOMERY WARD & CO.**, 619 W. Chicago Ave., Chicago, Ill., *"Airline"—PO, PR
- MUSIC MASTER MFG. CO.**, 508 S. Dearborn St., Chicago, Ill.—PO, PR
- NATIONAL COMPANY, INC.**, 61 Sherman St., Malden, Mass.—PR
- NORTHERN ELECTRIC CO., LTD.**, 1261 Shearer St., Montreal, Que., Can.—PO, PR
- OFFENBACH ELECTRIC CO.**, 1452 Market St., San Francisco, Calif.—KI, PO, PR
- OPERADIO MFG. CO.**, 13th & Indiana Sts., St. Charles, Ill.—PO, PR
- PACENT ENGINEERING CORP.**, 79 Madison Ave., New York, N. Y.—PO, PR
- PAR-METAL PRODUCTS CORP.**, 32-62 49th St., Long Island City, N. Y.—A
- PHILCO RADIO & TELEVISION CORP.**, Tioga & "C" Sts., Phila., Pa.—PO
- PHONOTONE LABORATORIES, INC.**, S.E. 15th St., Washington, Ind.—PO
- PRESTO RECORDING CORP.**, 242 W. 55th St., New York, N. Y.—PO, PR
- RADIO ELECTRIC SERVICE CO., INC.**, N. W. Cor. 7th & Arch Sts., Phila., Pa.—KI, PO, PR
- RADIO EQUIPMENT CORP.**, 326 Elm St., Buffalo, N. Y.—KI, PO, PR
- THE RADIOTECHNIC LABORATORY**, 1328 Sherman Ave., Evanston, Ill.—PO
- RADIOTONE, INC.**, 7356 Melrose Ave., Hollywood, Calif.—PO, PR
- RADOLEX COMPANY**, 601 W. Randolph St., Chicago, Ill.—KI, PO, PR
- THE RAYLAND CORPORATION**, 3333 Belmont Ave., Chicago, Ill.—PO, PR
- RCA MANUFACTURING CO., INC.**, Camden, N. J.—KI, PO, PR
- REGAL AMPLIFIER MFG. CORP.**, 14 W. 17th St., New York, N. Y.—PO, PR
- ROTOPHONE CORPORATION**, 26 Journal Sq., Jersey City, N. J.—HC
- ROWE INDUSTRIES, INC.**, 3120 Monroe St., Toledo, Ohio—PR
- ROWE RADIO RESEARCH LAB. CO.**, 4201 Irving Park Blvd., Chicago, Ill.—PR
- MAURICE SCHWARTZ & SON**, 710-712 Broadway, Schenectady, N. Y.—KI, PO, PR
- SETCHELL CARLSON, INC.**, 2233 University Ave., St. Paul, Minn.—PO, PR
- SHELLEY RADIO CO.**, 1841 S. Flower St., Los Angeles, Calif.—KI
- MARK SIMPSON DISTRIB. CO., INC.**, 16 Hudson St., New York, N. Y.—KI, PO
- S.O.S. CINEMA SUPPLY CORP.**, 636 11th Ave., New York, N. Y.—PO, PR, S
- SOUND APPARATUS CO.**, 150 W. 46th St., New York, N. Y.—PO, PR
- SUNDT ENGINEERING CO.**, 4787 Ravenswood Ave., Chicago, Ill.—PO
- SUN RADIO CO.**, 212 Fulton St., New York, N. Y.—KI, PO, PR

- TALK-A-PHONE MFG. CO.**, 1847 S. Millard Ave., Chicago, Ill.—PO
- TECHNICAL PRODUCTS INTERNATIONAL**, 135 Liberty St., New York, N. Y.—PO, PR
- TELEVISO COMPANY**, 341 N. Pulaski Rd., Chicago, Ill.—PO, PR
- THORDARSON ELECTRIC MFG. CO.**, 500 W. Huron St., Chicago, Ill.—KI, PO, PR
- TRANSFORMER CORP. OF AMERICA**, 69 Wooster St., New York, N. Y.—PO, PR
- TRY-MO RADIO CO., INC.**, 85 Cortlandt St., New York, N. Y.—KI, PO, PR
- UNITED TRANSFORMER CORP.**, 150 Varick St., New York, N. Y.—KI, PO, PR
- VICTOR ANIMATOGRAPH CORP.**, Davenport, Iowa—PO, PR
- WEBER MACHINE CORP.**, 59 Rutter St., Rochester, N. Y.—S
- THE WEBSTER-CHICAGO CORP.**, 5622 W. 81st St., Chicago, Ill., *"Webster-Chicago"—PO
- WEBSTER ELECTRIC CO.**, Clark & DeKanen Ave., Racine, Wis.—PO, PR
- WESTERN SOUND & ELEC. LABS., INC.**, 311 W. Kilbourn Ave., Milwaukee, Wis.—PO, PR

ANTENNAS & ACCESSORIES



- Aircraft AI
 - All-wave (home) A
 - Antenna eliminators AE
 - Auto antennas AA
 - Built-in line antennas B
 - Coaxial (concentric) cables CC
 - Frequency Modulation F
 - Ground clamps GC
 - Insulators IN
 - Kits KI
 - Kits (Aircraft) KA
 - Lightning arresters LA
 - Loop antennas L
 - Multiple (master) antenna systems M
 - Multiple (master) systems (sup-ports) MS
 - Noise-reducing NR
 - Outlets OU
 - Rhombic antennas & resistors RR
 - Rotary beam R
 - Television T
 - Television, F.M. & A.M. comb. TC
 - Towers & supports (commercial) TSC
 - Towers & supports (home) TS
 - Transmitter (& equipment) TR
 - Ultra-H.F. antennas UA
 - Ultra-H.F. (fixed freq'y.) coaxial UC
- ABC RADIO LABS.**, 3334 N. New Jersey St., Indianapolis, Ind.—AA
 - AEROVOX CORPORATION**, New Bedford, Mass.—NR
 - *"AIRLINE"—Montgomery Ward & Co.
 - ALLIED ENGINEERING INSTITUTE**, 85 Warren St., New York, N. Y.—KI
 - ALLIED RADIO CORP.**, 833 W. Jackson Blvd., Chicago, Ill., *"Knight"—A, AE, AA, B, CC, F, GC, IN, KI, LA, L, M, NR, T, TC, TS, UA, UC

Please say you saw it in the Radio-Craft "Classified Radio Directory"

• CLASSIFIED RADIO DIRECTORY •

*ALLIGATOR—Porcelain Products, Inc.
ALPHA WIRE CORP., 50 Howard St., New York, N. Y.—A, AA, CC, F, GC, IN, KI, LA, L, TC, UC
*ALSMAG—American Lava Corp.
AMERICAN COMMUNICATIONS CORP., 123 Liberty St., New York, N. Y.—A, B, GC, IN, M, NR, OU
AMERICAN LAVA CORP., Cherokee Blvd. & Manufacturers Rd., Chattanooga, Tenn., *"AlSiMag," "Lava"—IN
AMERICAN PHENOLIC CORP., 1250 Van Buren St., Chicago, Ill.—CC, IN, UC
AMERICAN RADIO HARDWARE CO., INC., 476 Broadway, New York, N. Y.—IN, OU
AMY, ACEVES & KING, INC., 11 W. 42nd St., New York, N. Y.—A, M, NR, OU
VICTOR J. ANDREW CO., 6429 S. Laverne Ave., Chicago, Ill.—CC, TR, UA, UC, TSC
*ANTENEX—M. M. Fleron & Son.
REX BASSETT, INC., 214 Star Bldg., Niles, Mich.—F, T, UA, TSC
BELDEN MFG. CO., 4647 W. Van Buren St., Chicago, Ill.—A, GC, IN, KI, LA, M, NR
BENDIX RADIO CORP., 920 E. Fort Ave., Baltimore, Md.—L
*BIRNBACH—Birnbach Radio Co., Inc.
BIRNBACH RADIO CO., INC., 145 Hudson St., New York, N. Y., *"Birnbach"—A, AE, F, GC, IN, KI, LA, T, TC, UA
BOND PRODUCTS CO., 13139 Hamilton Ave., Detroit, Mich.—AA, GC
L. S. BRACH MFG. CORP., 55 Dickerson St., Newark, N. J.—A, AA, B, F, GC, IN, KI, LA, L, M, NR, OU, TS
*BROWN DEVILS—Ohmite Manufacturing Co.
*BROWNIE—Porcelain Products, Inc.
BROWN MFG. CO., 403 W. Baltimore, Detroit, Mich.—F, KI
BUD RADIO, INC., 5205 Cedar Ave., Cleveland, Ohio—B, IN, OU
BURTON-ROGERS CO., Sales Div. for Hoyt Elec. Inst. Works, 857 Boylston St., Boston, Mass.—A, AA, F
CANADIAN MARCONI CO., 211 St. Sacramento St., Montreal, Can.—A, AA, CC, F, GC, IN, KI, LA, L, RR, TC, TS, UA, UC
CANADIAN RADIO CORP., LTD., 622 Fleet St., W., Toronto, Ont., Can.—A, AA, B, GC, IN, KI, LA
THE CARBORUNDUM CO., GLOBAL DIVISION, Niagara Falls, N. Y.—RR
CONSOLIDATED WIRE & ASSOCIATED CORP., 512 S. Peoria St., Chicago, Ill.—A, AA, B, F, GC, IN, KI, LA, L, M, MB, OU
CORNING GLASS WORKS, Corning, N. Y.—IN
CORNISH WIRE CO., 15 Park Row, New York, N. Y.—A, AE, GC, IN, KI, LA, NR, TC
THE CROSLER CORPORATION, Cincinnati, Ohio—A, AA, B
CRUMPACKER DISTRIB. CORP., 1801 Fannin St., Houston, Tex.—A, AA, GC, IN, KI, LA, NR
HAROLD DAVIS, INC., 428 W. Capital St., Jackson, Miss.—GC, IN, LA
*DETERMOM—Ohmite Mfg. Co.
DOOLITTLE RADIO, INC., 7421 Loomis Blvd., Chicago, Ill.—AA, CC, UC
DOW RADIO SUPPLY CO., 1759 E. Colorado, Pasadena, Calif.—A, AA, B, F, GC, IN, KI, LA, OU, TSC
EAGLE ELECTRIC MFG. CO., INC., 59 Hall St., Brooklyn, N. Y.—A, GC, IN, KI, LA, OU
*EFFARSEE—Fiswick Radio Co.
FARNSWORTH TELEVISION & RADIO CORP., 3700 E. Pontiac St., Ft. Wayne, Ind.—T, TC
FEDERATED PURCHASER, INC., 80 Park Place, New York, N. Y.—A, AE, AA, B, F, GC, IN, KI, LA, NR, T, TC, UA
FISCHER DISTRIB. CORP., 222 Fulton St., New York, N. Y.—A, AA, B, F, GC, IN, KI, LA, L, M, NR, OU, TS
FISHWICK RADIO CO., 139 W. 4th St., Cincinnati, Ohio, *"Effarsee"—A, AA, B, L, NR
*FLERON—M. M. Fleron & Son.
M. M. FLERON & SON, INC., 113 N. Broad St., Trenton, N. J.—A, F, GC, IN, KI, LA, NR, OU
*"Antenex," "Fleron," "Safest," "Signaler"
FONDA CORPORATION, 29 W. 57th St., New York, N. Y.—F, RR, T, TC
FOWLER MFG. CO., 9 Rutger St., St. Louis, Mo.—A
GENERAL CEMENT MFG. CO., 919 Taylor Ave., Rockford, Ill.—AE
GENERAL CERAMICS CO., Plant No. 3, Keasbey, N. J.—F, IN
GENERAL ELECTRIC CO., Schenectady, N. Y. & Bridgeport, Conn.—F, T, TSC
GOLDENTONE RADIO CO., 15123 Warren Ave., Dearborn, Mich.—A, AA, KI, NR
EDWIN I. GUTHMAN & CO., INC., 400 S. Peoria St., Chicago, Ill.—L
D. H. HARRELL, 1527 E. 74th Place, Chicago, Ill.—MS
HARRISON RADIO CO., 12 W. Broadway, New York, N. Y.—CC, F, GC, IN, KI, RR, T, UA, UC
HARVEY-WELLS COMMUNICATIONS, INC., North St., Southbridge, Mass.—UA, UC
HOME RADIO SERVICE, INC., 521 W. 48th St., New York, N. Y.—M
HOPE WEBBING CO., P.O. Box 1495, Providence, R. I.—A
HERBERT H. HORN, 1201 S. Olive St., Los Angeles, Calif.—A, AA, B, IN, KI, LA, L, NR, OU, TS
HOWARD RADIO CO., 1731 W. Belmont Ave., Chicago, Ill.—F, L

INSULINE CORP. OF AMERICA, 30-30 Northern Blvd., Long Island City, N. Y.—A, AA, B, F, GC, IN, KI, LA, L, TS
JAMES WIRE & CABLE CO., 1014 Madison Ave., Toledo, Ohio—A, KI
J.F.D. MANUFACTURING CO., 4111 Ft. Hamilton Pkwy., Brooklyn, N. Y.—A, AA, F, KI, TS
E. F. JOHNSON COMPANY, Waseca, Minn.—F, IN
*KNIGHT—Allied Radio Corp.
LAFAYETTE RADIO CORP., 100 6th Ave., New York, N. Y.—A, AA, F, GC, IN, KI, LA, L, M, NR, OU, TS
*LAVA—American Lava Corp.
*LEARADIO—Lear Avia, Inc.
LEAR AVIA, INC., 30 Rockefeller Plaza, New York, N. Y., *"Learadio"—A, UA
JOHN E. LINGO & SON, INC., 28th St. & Van Buren Ave., Camden, N. J.—F
FRED M. LINK, 125 W. 17th St., New York, N. Y.—AA, UC
M. & H. SPORTING GOODS CO., 512 Market St., Phila., Pa.—A, AA, GC, IN, LA, M, NR, OU
MAC-ADAMS EQUIPMENT CO., INC., 507 W. 56th St., New York, N. Y.—AA, F, T, TC
MAJESTIC RADIO & TELEVISION CORP., 2600 W. 50th St., Chicago, Ill.—L
MIDWEST RADIO CORP., 909 Broadway, Cincinnati, Ohio, *"Midwest"—A
JAMES MILLEN MFG. CO., INC., 150 Exchange St., Malden, Mass.—IN
MIMS RADIO CO., P. O. Box 504, Texarkana, Ark.—F, R
MONTGOMERY WARD & CO., 619 W. Chicago Ave., Chicago, Ill., *"Airline"—A, AA, B, CC, GC, IN, KI, LA
MUELLER ELECTRIC CO., 1583 E. 31st St., Cleveland, Ohio—GC
*MULTIVOLTS—Ohmite Manufacturing Co.
MUSIC MASTER MFG. CO., 508 S. Dearborn St., Chicago, Ill.—KI, NR
THE MUTER COMPANY, 1255 S. Michigan Ave., Chicago, Ill.—L
NOBLITT-SPARKS INDUSTRIES, INC., Columbus, Ind.—AA
NORTHERN ELEC. CO., LTD., 1261 Shearer St., Montreal, Que., Can.—A, B, GC, IN, KI, M, NR, OU
OFFENBACH ELECTRIC CO., 1452 Market St., San Francisco, Calif.—A, AA, F, GC, IN, KI, LA, L, NR, OU
*OHMITE—Ohmite Manufacturing Co.
OHMITE MANUFACTURING CO., 4835 W. Flournoy St., Chicago, Ill., *"Ohmite," "Brown Devils," "Multivolts," "Determinohm," "Riteohm"—RR
PACENT ENGINEERING CORP., 79 Madison Ave., New York, N. Y.—A, F, NR
PHILOCO RADIO & TELEVISION CORP., Tioja & "C" Sts., Phila., Pa.—A, AA, B, GC, IN, KI, LA, L, M, NR, TS
PHILMORE MANUFACTURING CO., INC., 113 University Pl., New York, N. Y.—GC, IN, KI, L, NR
PHILSON MANUFACTURING CO., INC., 156 Chambers St., New York, N. Y.—AA, F, T
PILOT RADIO CORP., 37-06 36th St., Long Island City, N. Y.—A, F
PIONEER SPECIALTY CO., 5100 St. Jean Ave., Detroit, Mich.—AA
PORCELAIN PRODUCTS, INC., P. O. Box 300, Findlay, Ohio, *"Brownie," "Alligator"—GC, IN, LA
PREMAX PRODUCTS DIV., CHISHOLM-RYDER CO., Drawer F, Bridge Sta., Niagara Falls, N. Y.—IN, TS
QUAM-NICHOLS CO., 33rd Pl. & Cottage Grove, Chicago, Ill.—KI, LA
RADEX CORPORATION, 1733 Milwaukee Ave., Chicago, Ill.—CC, F, M
RADIO ELECTRIC SERVICE CO., INC., N. W. Cor. 7th & Arch Sts., Phila., Pa.—A, AA, B, F, GC, IN, KI, LA, L, M, NR, OU, TS
RADIO EQUIPMENT CORP., 326 Elm St., Buffalo, N. Y.—A, AA, GC, IN, KI, LA, M, NR, OU
RADIO RECEPTOR CO., INC., 251 W. 19th St., New York, N. Y.—CC, UA, UC
RADOLEK COMPANY, 601 W. Randolph St., Chicago, Ill.—A, AE, AA, B, CC, F, GC, IN, KI, LA, L, M, OU, TS, UA
RCA MANUFACTURING CO., INC., Camden, N. J.—A, AA, B, F, GC, IN, KI, LA, L, M, NR, OU
*RITEOHM—Ohmite Manufacturing Co.
ROGERS-MAJESTIC CORP., LTD., 622 Fleet St., Toronto, Can.—A, KI
*SAFTEST—M. M. Fleron & Son.
MAURICE SCHWARTZ & SON, 710-712 Broadway, Schenectady, N. Y.—A, AA, B, F, GC, IN, KI, LA, L, M, NR, OU, TS
SEATTLE RADIO SUPPLY CO., INC., 2117 2nd Ave., Seattle, Wash.—A, CC, GC, IN, LA, RR, UA, UC
SHELLEY RADIO CO., 1841 S. Flower St., Los Angeles, Calif.—A, AA
H. B. SHERMAN MFG. CO., 22 Barney St., Battle Creek, Mich.—GC
*SIGNALER—M. M. Fleron & Son.
SNYDER, INC., Noble & Darien Sts., Phila., Pa.—A, AA, GC
STROMBERG-CARLSON TELEPHONE MFG. CO., 100 Carlson Rd., Rochester, N. Y.—A, B, F, KI, NR
SUN RADIO CO., 212 Fulton St., New York, N. Y.—A, AA, B, F, GC, IN, KI, LA, L, MS, NR, OU, TS
TAYLOR AIRPHONE PRODUCTS, Hangar 15, Long Beach Airport, Long Beach, Calif.—KA
TECHNICAL APPLIANCE CORP., 17 E. 16th St., New York, N. Y.—A, B, F, GC, IN, KI, LA, M, NR, T, TC, UA
TELERADIO ENGINEERING CORP., 484 Broome St., New York, N. Y.—B, F, KI, L, NR

TILTON ELECTRIC CORP., 15 E. 26th St., New York, N. Y.—F, NR
TREBOR RADIO CO., Pasadena, Calif.—L
TRICO FUSE MFG. CO., 2948 N. 5th St., Milwaukee, Wis.—GC
TRY-MO RADIO CO., INC., 85 Cortlandt St., New York, N. Y.—A, AE, AA, B, CC, F, GC, IN, KI, KA, LA, L, M, NR, OU, RR, T, TC, TS, UA, UC
VERTI-FLEX ILLINOIS SEATING CO., 2138 N. Racine Ave., Chicago, Ill.—A, F, M, NR
VERTROD MANUFACTURING CO., 132 Nassau St., New York, N. Y.—A, F, KI, NR, T, TC, UA
WARD PRODUCTS CORP., 1523 E. 45th St., Cleveland, Ohio—A
WESTINGHOUSE ELEC. & MFG. CO., E. Pittsburgh, Pa.—F, TSC
WINCHARGER CORPORATION, Sioux City, Iowa—TS
WIRT COMPANY, 5221-27 Greene St., Phila., Pa.—LA

AUTOMATIC TUNERS & PARTS



Inductance trimmer units	I
Mechanical selectors	M
Pushbutton identification tabs	PT
Pushbutton knobs	P
Pushbutton motor-operated units (complete)	PB
Pushbutton switches	PS
Pushbutton trimmer units (complete)	PU
Remote controls	RC
Station name cards	S
Temperature-compensating condensers	T
Trimmer condenser units	TC
Tuning motors	TM

ADVANCE ELECTRIC CO., 1260 W. 2nd St., Los Angeles, Calif.—RC
AEROVOX CORPORATION, New Bedford, Mass.—TC
*AIRLINE—Montgomery Ward & Co.
ALLIANCE MANUFACTURING CO., Alliance, Ohio—TM
ALLIED RADIO CORP., 833 W. Jackson Blvd., Chicago, Ill., *"Knight"—M, P, PS, RC, TC
AMERICAN RADIO HARDWARE CO., INC., 476 Broadway, New York, N. Y.—P, PS
ANSLEY RADIO CORP., 4377 Bronx Blvd., New York, N. Y.—RC
*ATOMS—Sprague Products Co.
BARKER & WILLIAMSON, Ardmore, Pa.—I, M, RC, TC
*BIRNBACH—Birnbach Radio Co., Inc.
BIRNBACH RADIO CO., INC., 145 Hudson St., New York, N. Y., *"Birnbach"—PS
DAVID BOGEN CO., 663 Broadway, New York, N. Y.—RC
CENTRALAB, DIV. OF GLOBE UNION, INC., 900 E. Keefe Ave., Milwaukee, Wis.—T, TC
CRUMPACKER DISTRIB. CORP., 1801 Fannin St., Houston, Tex.—I, M, P, PB, PS, PU, TC, TM
DOW RADIO SUPPLY CO., 1759 E. Colorado, Pasadena, Calif.—P, PS, RC
THE ELECTRO MOTIVE MFG. CO., INC., Williamantic, Conn.—PU, TC
EMPIRE NOTION CO., 105 E. 29th St., New York, N. Y.—P
ERIE RESISTOR CORP., 644 W. 12th St., Erie, Pa.—I, P, I, TC
FEDERATED PURCHASER, INC., 80 Park Place, New York, N. Y.—P, PS, TC
FISCHER DISTRIB. CORP., 222 Fulton St., New York, N. Y.—I, M, P, PB, PS, PU, RC, T, TC, TM
FONDA CORPORATION, 29 W. 57th St., New York, N. Y.—I, M, PT, P, PB, PS, PU, RC, TM
GENERAL CEMENT MFG. CO., 919 Taylor Ave., Rockford, Ill.—PT, S
GENERAL CERAMICS CO., Plant No. 3, Keasbey, N. J.—TC (bases only)
*GENERAL INSTRUMENT CORP., 829 Newark Ave., Elizabeth, N. J.—M
GORDON SPECIALTIES CO., 1104 S. Wabash Ave., Chicago, Ill.—S
CARL GORR PRINTING CO., 2615 N. Ashland Ave., Chicago, Ill.—PT
L. F. GRAMMES & SONS, INC., 361 Union St., Allentown, Pa.—PT
GUARDIAN ELECTRIC MFG. CO., 1621-27 W. Walnut St., Chicago, Ill.—RC
EDWIN I. GUTHMAN & CO., INC., 400 S. Peoria St., Chicago, Ill.—I, T, TC
HARRISON RADIO CO., 12 W. Broadway, New York, N. Y.—I, T
INSULINE CORP. OF AMERICA, 30-30 Northern Blvd., Long Island City, N. Y.—P, TC
*KNIGHT—Allied Radio Corp.
*KOOLHMS—Sprague Products Co.
KURZ-KASCH, INC., 1421 S. Broadway, Dayton, Ohio—P

Please say you saw it in the Radio-Craft "Classified Radio Directory"

• CLASSIFIED RADIO DIRECTORY •

LAFAYETTE RADIO CORP., 100 6th Ave., New York, N. Y.—I, M, P, PB, PS, PU, RC, T, TC, TM
 MAC-ADAMS EQUIPMENT CO., INC., 507 W. 56th St., New York, N. Y.—RC
 MAJESTIC RADIO & TELEVISION CORP., 2600 W. 50th St., Chicago, Ill.—I
 P. R. MALLORY & CO., INC., 3029 E. Washington St., Indianapolis, Ind.—PS
 MEISSNER MANUFACTURING CO., Mt. Carmel, Ill.—I, P
 JAMES MILLEN MFG. CO., INC., 150 Exchange St., Malden, Mass.—TC
 ELMER E. MILLS CORP., 812 W. Van Buren St., Chicago, Ill.—P
 MONTGOMERY WARD & CO., 619 W. Chicago Ave., Chicago, Ill., *Airline—TC
 THE MUTER COMPANY, 1255 S. Michigan Ave., Chicago, Ill.—PS, T, TC
 OAK MANUFACTURING CO., 1260 Clybourn Ave., Chicago, Ill.—M, PB, PS, PU
 OFFENBACH ELECTRIC CO., 1452 Market St., San Francisco, Calif.—I, M, P, PS, PU, RC, T, TC
 PACENT ENGINEERING CORP., 79 Madison Ave., New York, N. Y.—RC
 PARISIAN NOVELTY CO., 3510 S. Western Ave., Chicago, Ill.—PT, S
 PHILCO RADIO & TELEVISION CORP., Tioga & "C" Sts., Phila., Pa.—I, M, P, PB, PS, PU, RC, T, TC
 PIONEER GEN-E-MOTOR CORP., 466 W. Superior St., Chicago, Ill.—TM
RADIO ELECTRIC SERVICE CO., INC., N.W.
 Cor. 7th & Arch Sts., Phila., Pa.—I, M, P, PB, PS, PU, RC, T, TC, TM
 RADIO EQUIPMENT CORP., 326 Elm St., Buffalo, N. Y.—I, M, P, PS, PU, RC, T, TC, TM
 RADIO KNOB CO., 43 E. Ohio St., Chicago, Ill.—P
 RADOLEK COMPANY, 601 W. Randolph St., Chicago, Ill.—I, M, P, PS, PU, TC
 RCA MANUFACTURING CO., INC., Camden, N. J.—PU, RC, T, TC
 THE RICHARDSON COMPANY, 27th & Lake Sts., Melrose Park, Ill.—P
 ROGERS-MAJESTIC CORP., LTD., 622 Fleet St., Toronto, Can.—M, P
 MAURICE SCHWARTZ & SON, 710-712 Broadway, Schenectady, N. Y.—I, M, P, PB, PS, PU, RC, T, TC, TM
 SEATTLE RADIO SUPPLY CO., INC., 2117 2nd Ave., Seattle, Wash.—PS, T, TC
 *600 LINE—Sprague Products Co.
 SORENG-MANEGOLD CO., 1901 Clybourn Ave., Chicago, Ill.—PS
 SPRAGUE PRODUCTS CO., N. Adams, Mass., *600 Line, "Atoms", "Koolohms", "Telohmite"—T, TC
 F. W. STEWART MFG. CORP., 340 W. Huron St., Chicago, Ill.—RC
 SUN RADIO CO., 212 Fulton St., New York, N. Y.—I, M, P, PB, PS, PU, RC, T, TC, TM
 TELERADIO ENGINEERING CORP., 484 Broome St., New York, N. Y.—I, PU, RC, T, TC
 *TELOHMIT—Sprague Products Co.
 WESTINGHOUSE ELEC. & MFG. CO., E. Pittsburgh, Pa.—PS

AUTO-RADIO CONTROLS



Cable replacement tools . . . CT
 Control fittings . . . CF
 Control heads . . . C
 Controls (complete) . . . CC
 Flexible shafts . . . F

ALLIED RADIO CORP., 833 W. Jackson Blvd., Chicago, Ill., *Knight—CT, CF, C, CC, F
 AMERICAN RADIO HARDWARE CO., INC., 476 Broadway, New York, N. Y.—CT, CF
 CANADIAN RADIO CORP., LTD., 622 Fleet St., W., Toronto, Ont., Can.—C, F
 CROWE NAME PLATE & MFG. CO., 3701 Ravenswood Ave., Chicago, Ill.—F, C, CC, F
 CRUMPACKER DISTRIB. CORP., 1801 Fannin St., Houston, Tex.—CT, CF, C, CC, F
 HAROLD DAVIS, INC., 428 W. Capital St., Jackson, Miss.—CT, CF, C, CC, F
 DOW RADIO SUPPLY CO., 1759 E. Colorado, Pasadena, Calif.—CT, CF, C, CC, F
 DUAL REMOTE CONTROL CO., INC., 31776 W. Warren Ave., Wayne, Mich.—CF, C, CC, F
 ERIE RESISTOR CORP., 644 W. 12th St., Erie, Pa.—CF
 FEDERATED PURCHASER, INC., 80 Park Place, New York, N. Y.—CF, C, F
 FISCHER DISTRIB. CORP., 222 Fulton St., New York, N. Y.—CT, CF, C, CC, F
 GALVINA MANUFACTURING CORP., 4545 W. Augusta Blvd., Chicago, Ill., *Motorola—CF, C, F
 J. F. D. MANUFACTURING CO., 4111 Ft. Hamilton Pkwy., Brooklyn, N. Y.—CT, CF, F
 *KNIGHT—Allied Radio Corp.
 LAFAYETTE RADIO CORP., 100 6th Ave., New York, N. Y.—CT, CF, C, CC, F

MAC-ADAMS EQUIPMENT CO., INC., 507 W. 56th St., New York, N. Y.—CF, C, CC, F
 P. R. MALLORY & CO., INC., 3029 E. Washington St., Indianapolis, Ind.—F
 *MOTOROLA—Galvin Manufacturing Corp.
 OFFENBACH ELECTRIC CO., 1452 Market St., San Francisco, Calif.—F
 PHILCO RADIO & TELEVISION CORP., Tioga & "C" Sts., Phila., Pa.—CF, C, CC, F
RADIO ELECTRIC SERVICE CO., INC., N.W.
 Co. 7th & Arch Sts., Phila., Pa.—CT, CF, C, CC, F
 RADIO EQUIPMENT CORP., 326 Elm St., Buffalo, N. Y.—CT, CF, C, CC, F
 RADOLEK COMPANY, 601 W. Randolph St., Chicago, Ill.—CT, CF, C, CC, F
 RCA MANUFACTURING CO., INC., Camden, N. J.—CT, CF, C, CC, F (these products for car mfrs. only)
 MAURICE SCHWARTZ & SON, 710-712 Broadway, Schenectady, N. Y.—CT, CF, C, CC, F
 SHELLEY RADIO CO., 1841 S. Flower St., Los Angeles, Calif.—C, F
 F. W. STEWART MFG. CORP., 340 W. Huron St., Chicago, Ill.—CT, CF, C, CC, F
 SUN RADIO CO., 212 Fulton St., New York, N. Y.—CT, CF, C, CC, F

AIRCRAFT RADIO

(see Receiving Sets [including Adapters & Converters])

BATTERY CHARGERS (& PARTS)



Automatic switches . . . AS
 Battery-charging tubes . . . BT
 Gas-engine chargers . . . GC
 Powerline chargers (home) . PH
 Powerline chargers (service station) . . . V
 Vibrator chargers . . . V
 Wind-driven chargers . . . WC

*AIRLINE—Montgomery Ward & Co.
 ALLEN ELEC. & EQUIP. CO., 2101 N. Pitcher St., Kalamazoo, Mich.—BT, PS
 ALLIED RADIO CORP., 833 W. Jackson Blvd., Chicago, Ill., *Knight—BT, GC, PH, V, WC
 AMERICAN COMMUNICATIONS CORP., 123 Liberty St., New York, N. Y.—BT, PH
 AMERICAN TELEVISION & RADIO CO., 300 E. 4th St., St. Paul, Minn.—PH, V
 AUTOMATIC ELECTRICAL DEVICES CO., 324 E. 3rd St., Cincinnati, Ohio—PH, V
 THE BENWOOD-LINZE CO., 1870 Washington Ave., St. Louis, Mo.—BT, PH, PS
 CANADIAN MARCONI CO., 211 St. Sacramento St., Montreal, Can.—BT, GC, PH, PS, V, WC
 *CHARGIT—Chargit Corporation
 CHARGIT CORPORATION, Citizens Bank Bldg., Anderson, Ind., *Chargit—PH
 CINEMA ENGINEERING CO., 1508 W. Verdugo Ave., Burbank, Calif.—PH
 CONTINENTAL ELECTRIC CO., Geneva, Ill.—BT
 CRUMPACKER DISTRIB. CORP., 1801 Fannin St., Houston, Tex.—GC, PH, PS, V, WC
 HAROLD DAVIS, INC., 428 W. Capital St., Jackson, Miss.—GC, WC
 DOW RADIO SUPPLY CO., 1759 E. Colorado, Pasadena, Calif.—BT, V
 EICOR, INC., 515 S. Laffin St., Chicago, Ill.—GC, WC
 ELECTRONIC PRODUCTS CO., St. Charles, Ill.—PS
 FEDERAL TELEGRAPH CO., 200 Mt. Pleasant Ave., Newark, N. J.—BT, PS
 FEDERATED PURCHASER, INC., 80 Park Place, New York, N. Y.—BT, GC, PH, V, WC
 FISCHER DISTRIB. CORP., 222 Fulton St., New York, N. Y.—FC, PH, PS, WC
 GENERAL ELECTRIC CO., Schenectady, N. Y. & Bridgeport, Conn.—BT, PH, PS
 HARRISON RADIO CO., 12 W. Broadway, New York, N. Y.—BT, GC, PH, V
 HARTMAN ELECTRICAL MFG. CO., Mansfield, Ohio—AS, PH
 *HETRO—Hetro Electrical Industries, Inc.
 HETRO ELECTRICAL INDUSTRIES, INC., 5819 N. Drake Ave., Chicago, Ill., *Hetro—GC
 JANETTE MANUFACTURING CO., 556 W. Monroe St., Chicago, Ill.—GC
 KATO ENGINEERING CO., INC., 530 N. Front St., Mankato, Minn.—GC
 *KNIGHT—Allied Radio Corp.
 LAFAYETTE RADIO CORP., 100 6th Ave., New York, N. Y.—BT, GC, PH, PS, V, WC

LAUREHK RADIO MFG. CO., 3918 Monroe Ave., Wayne, Mich.—PH
 THE LAUSON COMPANY, New Holstein, Wis.—GC
 LeJAY MANUFACTURING CO., 1406 W. Lake St., Minneapolis, Minn.—GC, PH
 P. R. MALLORY & CO., INC., 3029 E. Washington St., Indianapolis, Ind.—PH, V
 MEISSNER MANUFACTURING CO., Mt. Carmel, Ill.—V
 MIDCO MFG. & DISTRIB. CO., INC., S. 13th & Kentucky Ave., Sheboygan, Wis.—GC
 MONTGOMERY WARD & CO., 619 W. Chicago Ave., Chicago, Ill., *Airline—BT, GC, PH, WC
 NATIONAL COMPANY, INC., 61 Sherman St., Malden, Mass.—V
 OAK MANUFACTURING CO., 1260 Clybourn Ave., Chicago, Ill.—V
 OFFENBACH ELECTRIC CO., 1452 Market St., San Francisco, Calif.—BT, GC, PH, PS, V
 PIONEER GEN-E-MOTOR CORP., 466 W. Superior St., Chicago, Ill.—GC
 *ONAN—D. W. Onan & Sons
 D. W. ONAN & SONS, 43 Royalston Ave., Minneapolis, Minn., *Onan—GC
RADIO ELECTRIC SERVICE CO., INC., N.W.
 Cor. 7th & Arch Sts., Phila., Pa.—BT, GC, PH, WC
 RADIO EQUIPMENT CORP., 326 Elm St., Buffalo, N. Y.—BT, PH, V
 RADOLEK COMPANY, 601 W. Randolph St., Chicago, Ill.—BT, PH
 MAURICE SCHWARTZ & SON, 710-712 Broadway, Schenectady, N. Y.—BT, GC, PH, PS, V, WC
 SEATTLE RADIO SUPPLY CO., INC., 2117 2nd Ave., Seattle, Wash.—BT, GC, PH, PS, B
 SHELLEY RADIO CO., 1841 S. Flower St., Los Angeles, Calif.—BT
 S.O.S. CINEMA SUPPLY CORP., 636 11th Ave., New York, N. Y.—BT, PH
 SUN RADIO CO., 212 Fulton St., New York, N. Y.—BT, GC, PH, V, WC
 TECHNICAL PRODUCTS INTERNATIONAL, 135 Liberty St., New York, N. Y.—GC, PH, PS, WC
 UNITED TRANSFORMER CORP., 150 Varick St., New York, N. Y.—BT, PH
 WARD LEONARD ELECTRIC CO., 31 South St., Mt. Vernon, N. Y.—PS
 EARL WEBBER CO., 4348 W. Roosevelt Rd., Chicago, Ill.—BT, PS
 JOS. WEIDENHOFF, INC., 4344 W. Roosevelt Rd., Chicago, Ill.—BT, PS
 WILLARD STORAGE BATTERY CO., 246 E. 131st St., Cleveland, Ohio—BT, PS
 WINCHARGER CORPORATION, Sioux City, Iowa—GC, WC

BATTERIES (& CELLS) DRY & WET (STORAGE)



"A" dry-batteries . . . AB
 "B" dry-batteries . . . BB
 "C" dry-batteries . . . CB
 Bias cells (oxide) . . . BC
 Drycells . . . D
 Flashlight drycells . . . FD
 Flashlight storage cells . . . FS
 Hearing-aid dry-batteries . . . HA
 Miniature portable dry-batteries . . . MP
 Storage batteries . . . SB

AIR-ELECTRIC MACHINE CO., INC., Lohrville, Iowa—SB
 *AIRLINE—Montgomery Ward & Co.
 ALLIED RADIO CORP., 833 W. Jackson Blvd., Chicago, Ill., *Knight—AB, BB, CB, BC, D, FD, MP, SB
 BOND ELECTRIC CORP., DIV. OF WESTERN CRUTRIDGE CO., 275 Winchester Ave., New Haven, Conn.—AB, BB, CB, BC, D, FD, MP
 *BRIGHT STAR—Bright Star Battery Co.
 BRIGHT STAR BATTERY CO., Clifton, N. J., *Bright Star, "Unedit", "Eclipse", "Mars"—AB, BB, CB, BC, D, FD, MP
 BURGESS BATTERY CO., Freeport, Ill.—AB, BB, CB, BC, D, FD, HA, MP (dry)
 CANADIAN MARCONI CO., 211 St. Sacramento St., Montreal, Can.—AB, BB, CB, BC, D, MP, SB
 CANADIAN RADIO CORP., LTD., 622 Fleet St., W., Toronto, Ont., Can.—AB, BB, CB, D, FD, MP, SB
 *CHARGIT—Chargit Corporation
 CHARGIT CORPORATION, Henderson, Ind., *Chargit—FD, FS, MP, SB
 THE CROSLY CORPORATION, Cincinnati, Ohio—AB, BB
 CRUMPACKER DISTRIB. CORP., 1801 Fannin St., Houston, Tex.—AB, BB, CB, D, FD, MP
 DOW RADIO SUPPLY CO., 1759 E. Colorado, Pasadena, Calif.—AB, BB, CB, D, FD, MP
 *ECLIPSE—Bright Star Battery Co.
 FEDERATED PURCHASER, INC., 80 Park Place, New York, N. Y.—AB, BB, CB, BC, D, FD, MP

Please say you saw it in the Radio-Craft "Classified Radio Directory"

CLASSIFIED RADIO DIRECTORY

FISCHER DISTRIB. CORP., 222 Fulton St., New York, N. Y.—AB, BB, CB, D, FD, MP
 GENERAL DRY BATTERIES, INC., 13000 Athens Ave., Cleveland, Ohio—AB, BB, CB, D, FD, MP
 GLOBE PHONE MFG. CORP., Reading, Mass.—AB, BB
 GOLDENTONE RADIO CO., 15123 Warren Ave., Dearborn, Mich.—AB, BB, MP
 HARRISON RADIO CO., 12 W. Broadway, New York, N. Y.—AB, BB, CB, BC, D, MP
 HERBERT H. HORN, 1201 S. Olive St., Los Angeles, Calif.—AB, BB, CB, D, FD, MP
 IDEAL COMMUTATOR DRESSER CO., Sycamore, Ill.—FS
 KELLOGG SWITCHBOARD & SUPPLY CO., 6650 S. Cicero Ave., Chicago, Ill.—AB, BB, CB, D, FD
 "KNIGHT"—Allied Radio Corp.
 LAFAYETTE RADIO CORP., 100 6th Ave., New York, N. Y.—AB, BB, CB, D, FD, MP, SB
 LeJAY MANUFACTURING CO., 1406 W. Lake St., Minneapolis, Minn.—AB
 M. & G. HEARING AIDS CO., 30 N. Michigan Ave., Chicago, Ill.—AB, BB, CB, D, FD, MP
 M & H SPORTING GOODS CO., 512 Market St., Phila., Pa.—AB, BB, CB, D, FD, MP
 *MARS—Bright Star Battery Co.
 MONTGOMERY WARD & CO., 619 W. Chicago Ave., Chicago, Ill., *"Airline"—AB, BB, CB, D, MP, SB
 NATIONAL CARBON CO., INC., 30 E. 42nd St., New York, N. Y.—AB, BB, CB, D, FD, MP
 NATIONAL UNION RADIO CORP., 57 State St., Newark, N. J.—AB, BB, CB, MP
 NORTHERN ELECTRIC CO., LTD., 1261 Shearer St., Montreal, Que., Can.—AB, BB, CB, D, FD, MP, SB
 OFFENBACH ELECTRIC CO., 1451 Market St., San Francisco, Calif.—AB, BB, CB, D, FD, MP
 PHILCO RADIO & TELEVISION CORP., Tioga & "C" Sts., Phila., Pa.—AB, BB, CB, D, FD, MP, SB
RADIO ELECTRIC SUPPLY CO., INC., N. W. Cor. 7th & Arch Sts., Phila., Pa.—AB, BB, CB, D, FD, MP, SB
 RADIO EQUIPMENT CORP., 326 Elm St., Buffalo, N. Y.—AB, BB, CB, D, FD, MP
 RADOLEK COMPANY, 601 W. Randolph St., Chicago, Ill.—AB, BB, CB, BC, D, FD, MP, SB
 RAY-O-VAC COMPANY, Madison, Wis.—AB, BB, CB, D, FD, MP
 MAURICE SCHWARTZ & SON, 710-712 Broadway, Schenectady, N. Y.—AB, BB, CB, D, FD, MP
 SEATTLE RADIO SUPPLY CO., INC., 2117 2nd Ave., Seattle, Wash.—AB, BB, CB, BC, D, FD, MP, SB
 SENTINEL RADIO CORP., 2020 Ridge Ave., Evans- ton, Ill.—AB, BB, MP
 SHELLEY RADIO CO., 1841 S. Flower St., Los Angeles, Calif.—AB, BB, CB, D, FD, MP, SB
 SUN RADIO CO., 212 Fulton St., New York, N. Y.—AB, BB, CB, D, FD, MP
 TAYLOR AIRPHONE PRODUCTS, Hangar 15, Long Beach Airport, Long Beach, Calif.—AB, BB, CB, D, MP
 TRY-MO RADIO CO., INC., 85 Cortlandt St., New York, N. Y.—AB, BB, CB, BC, D, FD, MP, SB
 *UNEEDIT—Bright Star Battery Co.
 WESTINGHOUSE ELEC. & MFG. CO., E. Pittsburgh, Pa.—BT, PH, PS
 WILLARD STORAGE BATTERY CO., 246 E. 131st St., Cleveland, Ohio—AB, BB, CB, D, FD, SB
 WINCHARGER CORPORATION, Sioux City, Iowa—SB

BOOKS

(see Service Manuals, Books & Magazines)

CABINETS, CASES, PARTS & SERVICES

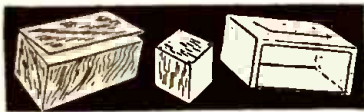

Cabinet re-covering (leather, etc.)	CR
Cabinet refinishing kits & materials	CK
Console (wood)	CC
Leather	L
Metal	MC
Mirror	M
Plastic	PC
Portable cases	P
Speaker housings	S
Table (wood)	TC

*"AIRLINE"—Montgomery Ward & Co.
 ALLIED RADIO CORP., 833 W. Jackson Blvd., Chicago, Ill., *"Knight"—CK, MC
 VICTOR J. ANDREW CO., 6429 S. Laverne Ave., Chicago, Ill.—MC
 ANSLEY RADIO CORP., 4377 Bronx Blvd., New York, N. Y.—CC, TC
 ATLAS SOUND CORP., 1451 39th St., Brooklyn, N. Y.—CC
 AUBURN BUTTON WORKS, INC., Auburn, N. Y.—PC

BOONTON MOLDING CO., 326 Myrtle Ave., Boonton, N. J.—PC
 BUD RADIO, INC., 5205 Cedar Ave., Cleveland, Ohio—MC
 CANADIAN MARCONI CO., 211 St. Sacramento St., Montreal, Can.—MC
 CASTLEWOOD MANUFACTURING CO., 12th & Burnett Sts., Louisville, Ky.—CC, TC
 THE CASWELL-RUNYAN CO., Huntington, Ind.—CC
 CHICAGO MOLDED PRODUCTS CORP., 1020 N. Kolmar Ave., Chicago, Ill.—PC
 CHICAGO SOUND SYSTEMS CO., 315 E. Grand Ave., Chicago, Ill.—MC (record cases)
 CHURCHILL CABINET CO., 2119 Churchill St., Chicago, Ill.—CC, TC
 DOW RADIO SUPPLY CO., 1759 E. Colorado, Pasadena, Calif.—MC, TC
 FEDERATED PURCHASER, INC., 80 Park Place, New York, N. Y.—CK
 GENERAL CEMENT MFG. CO., 919 Taylor Ave., Rockford, Ill.—CK
 GENERAL ELECTRIC CO., Schenectady, N. Y. & Bridgeport, Conn.—PC
 L. F. GRAMMES & SONS, INC., 364 Union St., Allentown, Pa.—MC
 ROBERT M. HADLEY CO., 709 E. 61st St., Los Angeles, Calif.—MC
 HAMMOND MANUFACTURING CO., Guelph, Ont., Can.—MC
 HARTONE MANUFACTURING CORP., 127-33 S. 15th St., Newark, N. J.—L, P
 HARRISON RADIO CO., 12 W. Broadway, New York, N. Y.—MC
 HAWLEY PRODUCTS CO., 201 N. First Ave., St. Charles, Ill.—PC
 ILLINOIS CABINET CO., 2525 11th St., Rockford, Ill.—CC, TC
 INSULINE CORP. OF AMERICA, 30-30 Northern Blvd., Long Island City, N. Y.—MC
 KARP METAL PRODUCTS CO., 129 30th St., Brooklyn, N. Y.—MC
 *KNIGHT—Allied Radio Corp.
 LAFAYETTE RADIO CORP., 100 6th Ave., New York, N. Y.—CC, MC, PC, TC
 LeFEBURE CORPORATION, Cedar Rapids, Iowa—MC
THE LINCROPHONE CO., INC., 1661 Howard Ave., Utica, N. Y.—CC
 MAJESTIC RADIO & TELEVISION CORP., 2600 W. 50th St., Chicago, Ill.—TC
 T. R. McELROY, 100 Brookline Ave., Boston, Mass.—PC
 MEISSNER MANUFACTURING CO., Mt. Carmel, Ill.—MC
 MIDWEST RADIO CORP., 909 Broadway, Cincinnati, Ohio, *"Midwest"—CC, TC
 JAMES MILLEN MFG. CO., INC., 150 Exchange St., Malden, Mass.—MC
 J. W. MILLER CO., 5917 S. Main St., Los Angeles, Calif.—MC
 MONTGOMERY WARD & CO., 619 W. Chicago Ave., Chicago, Ill., *"Airline"—MC
 NATIONAL COMPANY, INC., 61 Sherman St., Malden, Mass.—MC
 NORTHERN ELECTRIC CO., LTD., 1261 Shearer St., Montreal, Que., Can.—MC
 OFFENBACH ELECTRIC CO., 1452 Market St., San Francisco, Calif.—MC
 PACENT ENGINEERING CORP., 79 Madison Ave., New York, N. Y.—CC, TC
 PAR-METAL PRODUCTS CORP., 32-62 49th St., Long Island City, N. Y.—MC
 PAUL & BECKMAN, Div. of PHILA. LAWN MOWER & MFG. CO., 4250 Wissahickon Ave., Phila., Pa.—MC
 PHILCO RADIO & TELEVISION CORP., Tioga & "C" Sts., Phila., Pa.—CC, MC, PC, TC
 HOWARD A. PRATT, 665 5th Ave., New York, N. Y.—CR, L, M
 RADOLEK COMPANY, 601 W. Randolph St., Chicago, Ill.—CK, CC, MC, PC, TC
 RCA MANUFACTURING CO., INC., Camden, N. J.—CC, MC, PC, TC
 THE RICHARDSON COMPANY, Melrose Park, Ill.—PC
 RQCK-OLA MANUFACTURING CORP., 800 N. Kedzie Ave., Chicago, Ill.—CC, TC
 ROGERS-MAJESTIC CORP., LTD., 622 Fleet St., Toronto, Can.—CC, PC, TC
 WALTER L. SCHOTT CO., 5266 W. Pico Blvd., Los Angeles, Calif., *"Walsco"—CK
 MAURICE SCHWARTZ & SON, 710-712 Broadway, Schenectady, N. Y.—CC, MC, PC, TC
 SHELLEY RADIO CO., 1841 S. Flower St., Los Angeles, Calif.—PC
 MARK SIMPSON DISTRIB. CO., INC., 16 Hudson St., New York, N. Y.—S
 STEGER FURNITURE MFG. CO., 34th St. & C. & E.I.R.R., Steger, Ill.—CC, TC
 STEVENS-WALDEN, INC., 475 Shrewsbury St., Worcester, Mass.—MC
 SUN RADIO CO., 212 Fulton St., New York, N. Y.—CC, MC
 SYRACUSE ORNAMENTAL CO., Syracuse, N. Y.—PC
 E. TOMAN & CO., 2621 W. 21st Pl., Chicago, Ill.—CC, MC, PC, TC
 UNION STEEL CHEST CORP., 54 Church St., LeRoy, N. Y.—MC
 THE VEGA COMPANY, 155 Columbus Ave., Boston, Mass., *"Vega" "Vitar"—TC

*VEGA—The Vega Company
 *VITAR—The Vega Company
 *WALSco—Walter L. Schott Co.
 THE WATERBURY BUTTON CO., Waterbury, Conn.—PC
 WATTERSON RADIO MFG. CO., Box 54, Dallas, Tex.—CC, S, TC
 WILCOX ELECTRIC CO., INC., 40th & State Line, Kansas City, Mo.—MC
 THE WINNEBAGO MANUFACTURING CO., 1109 Seminary St., Rockford, Ill.—CC

CHEMICALS FOR RADIO



Cabinet touch-up chemicals	C
Dial oil	D
Phosphors	P
Record (disc) lubricant	R
Turntable lubricant	T

EIMER & AMEND, 3rd Ave. & 18th St., New York, N. Y.—P
 GENERAL CEMENT MFG. CO., 1041 Kilburn Ave., Rockford, Ill.—C, D, P, R, T

COILS & TRANSFORMERS (R.F. & I.F.) & ACCESSORIES



Coil forms	CF
Coil-winding equipment	CE
I.F. coils	IFC
Iron-core types	ICT
R.F. chokes (receiving)	RC
R.F. chokes (transmitting)	TC
R.F. coils (receiving)	RFC
Transmitting coils	TR

*AIRLINE—Montgomery Ward & Co.
 ALLIED RADIO CORP., 833 W. Jackson Blvd., Chicago, Ill., *"Knight"—CF, CE, IFC, ICT, RC, TC, RFC, TR
 *ALSIMAG—American Lava Corp.
 AMERICAN LAVA CORP., Cherokee Blvd. & Manufacturers Rd., Chattanooga, Tenn., *"Alsimag", "Lava"—CF
 AMERICAN PHENOLIC CORP., 1250 Van Buren St., Chicago, Ill.—CF
 AUBURN BUTTON WORKS, INC., Auburn, N. Y.—CF
 BARBER & HOWARD, INC., East Ave., Westerly, R. I.—IFC, RC, RFC
 BARKER & WILLIAMSON, Ardmore, Pa.—CF, CE, TR
 BOND PRODUCTS CO., 13139 Hamilton Ave., Detroit, Mich.—CF, IFC, RC
 BROWNING LABORATORIES, INC., 750 Main St., Winchester, Mass.—IFC, RFC, TR
 BUD RADIO, INC., 5205 Cedar Ave., Cleveland, Ohio—CF, RC, TR
 WM. W. L. BURNETT RADIO LAB., 4814 Idaho St., San Diego, Calif.—RC, TC, RFC
 CANADIAN MARCONI CO., 211 St. Sacramento St., Montreal, Can.—IFC, ICT, RC, TC, RFC, TR
 CARRON MANUFACTURING CO., 415 S. Aberdeen St., Chicago, Ill.—CF, IFC, ICT, RC, RFC, TC, TR
 CONSOLIDATED WIRE & ASSOCIATED CORPS., 512 Peoria St., Chicago, Ill.—CF, CE, IFC, RC, RFC, TR
 CONTINENTAL-DIAMOND FIBRE CO., Newark, Dela.—CF
 CRUMPACKER DISTRIB. CORP., 1801 Fannin St., Houston, Tex.—CF, CE, IFC, RC, RFC, TR
 HAROLD DAVIS, INC., 428 W. Capital St., Jackson, Miss.—CF, CE, IFC, RC, RFC, TR
 DELTA RADIO CORP., 115 Worth St., New York, N. Y.—IFC, RC, RFC, TR
 DOOLITTLE RADIO, INC., 7421 Loomis Blvd., Chicago, Ill.—TR
 DOW RADIO SUPPLY CO., 1759 E. Colorado, Pasadena, Calif.—CF, IFC, RC, RFC, TR
 EISLER ENGINEERING CO., 750 S. 13th St., Newark, N. J.—CE
 ELECTRONIC APPLICATIONS, Brunswick, Me.—IFC, RC, RFC, TR
 JOHN E. FAST & CO., 3123 N. Pulaski Ave., Chicago, Ill.—RC
 FEDERATED PURCHASER, INC., 80 Park Place, New York, N. Y.—CF, CE, IFC, ICT, RC, RFC, TC, TR
 FISCHER DISTRIB. CORP., 222 Fulton St., New York, N. Y.—CF, CE, IFC, RC, RFC, TR
 GENERAL CERAMICS CO., Plant No. 3, Keasbey, N. J.—CF (ceramic only)
 GENERAL TRANSFORMER CORP., 1250 W. Van Buren St., Chicago, Ill.—ICT

Please say you saw it in the Radio-Craft "Classified Radio Directory"

EDWIN I. GUTHMAN & CO., INC., 400 S. Peoria St., Chicago, Ill.—CE, IFC, ICT, RC, TC, RFC
 HAMMARLUND MFG. CO., INC., 424 W. 33rd St., New York, N. Y.—CF, IFC, RC, RFC, TR
 HAMMOND MANUFACTURING CO., Guelph, Ont., Can.—TR
 HARRISON RADIO CO., 12 W. Broadway, New York, N. Y.—CF, IFC, KCT, RC, TC, RFC, TR
 HERBERT H. HORN, 1201 S. Olive St., Los Angeles, Calif.—IFC, RC, RFD
 INSULINE CORP. OF AMERICA, 30-30 Northern Blvd., Long Island City, N. Y.—CF, IFC, RC, RFC, TR
 E. F. JOHNSON CO., Waseca, Minn.—RC, TR
 *KNIGHT—Allied Radio Corp.
 LAFAYETTE RADIO CORP., 100 6th Ave., New York, N. Y.—CF, CE, IFC, RC, RFC, TR
 *LAVA—American Lava Corp.
 MAJESTIC RADIO & TELEVISION CORP., 2600 W. 50th St., Chicago, Ill.—IFC, RC, RFC
 MEISSNER MANUFACTURING CO., Mt. Carmel, Ill.—CF, CE, IFC, ICT, RC, TC, RFC
 M & H SPORTING GOODS CO., 512 Market St., Phila., Pa.—IFC, RC, RFC, TR
 MILES REPRODUCER CO., INC., 812 Broadway, New York, N. Y.—CF, CE, IFC, RC, RFC, TR
 JAMES MILLEN MFG. CO., INC., 150 Exchange St., Malden, Mass.—CF, IFC, ICT, RC, TC, RFC, TR
 J. W. MILLER CO., 5917 S. Main St., Los Angeles, Calif.—IFC, RC, RFC
 MONTGOMERY WARD & CO., 619 W. Chicago Ave., Chicago, Ill., *Airline—CF, TC, RFC, TR
 THE MUTER COMPANY, 1255 S. Michigan Ave., Chicago, Ill.—IFC, RC, RFC
 NATIONAL COMPANY, INC., 61 Sherman St., Malden, Mass.—CF, IFC, RC, RFC, TR
 OFFENBACH ELECTRIC CO., 1452 Market St., San Francisco, Calif.—CF, CE, IFC, RC, RFC, TR
 PHILCO RADIO & TELEVISION CORP., Tioga & "C" Sts., Phila., Pa.—IFC, RC, RFC
 RADEX CORPORATION, 1733 Milwaukee Ave., Chicago, Ill.—CF, CE, IFC, ICT, RC, TC, RFC, TR
RADIO ELECTRIC SERVICE CO., INC., N. W.
 Cor. 7th & Arch Sts., Phila., Pa.—CF, CE, IFC, RC, RFC, TR
 RADIO ENGINEERING LABS., INC., 35-54 36th St., Long Island City, N. Y.—TR
 RADIO EQUIPMENT CORP., 326 Elm St., Buffalo, N. Y.—CF, IFC, RC, RFC, TR
 RADIO RECEPTOR CO., INC., 251 W. 19th St., New York, N. Y.—TR
 RADOLEK COMPANY, 601 W. Randolph St., Chicago, Ill.—CF, CE, IFC, ICT, RC, TC, RFC, TR
 RCA MANUFACTURING CO., INC., Camden, N. J.—IFC, RC, RFC
 ROGERS-MAJESTIC CORP., LTD., 622 Fleet St., Toronto, Can.—CF, IFC, RC, RFC
 MAURICE SCHWARTZ & SON, 710-712 Broadway, Schenectady, N. Y.—CF, CE, IFC, RC, RFC, TR
 SEATTLE RADIO SUPPLY CO., INC., 2117 2nd Ave., Seattle, Wash.—IFC, RCT, RC, TC, RFC, TR
 SHELLEY RADIO CO., 1841 S. Flower St., Los Angeles, Calif.—IFC, RC, RFC
 SUN RADIO CO., 212 Fulton St., New York, N. Y.—CF, CE, IFC, RC, RFC, TR
 TAYLOR FIBRE CO., Norristown, Pa.—CF
 TELERADIO ENGINEERING CORP., 484 Broome St., New York, N. Y.—CF, CE, IFC, RC, RFC, TR
 TILTON ELECTRIC CORP., 15 E. 26th St., New York, N. Y.—RC
 TRY-MO RADIO CO., INC., 85 Cortlandt St., New York, N. Y.—CF, CE, IFC, ICT, RC, TC, RFC, TR
 UNITED STATES TELEVISION MFG. CORP., 220 E. 51st St., New York, N. Y.—IFC
 WESTINGHOUSE ELEC. & MFG. CO., E. Pittsburgh, Pa.—TR
 WILCOX ELECTRIC CO., INC., 40th & State Line, Kansas City, Mo.—IFC, RFC

COIN CONTROLS

(see Records & Record-Playing Equipment; also, Receiving Sets)

CONDENSERS, FIXED



Ceramic	CE
Compensating	CC
Electrolytic (dry)	E
Electrolytic (wet)	EL
Industrial	IN
Padding (mica)	MP
Polystyrene	P
Power factor correction	PC
Receiving (mica)	MR
Receiving (paper)	PR
Television	TC
Transmitting	TR

AEROVOX CORPORATION, New Bedford, Mass.—E, EL, IN, MP, MR, PR, PC, TC, TR
 *AIRLINE—Montgomery Ward & Co.

ALLIED RADIO CORP., 833 W. Jackson Blvd., Chicago, Ill., *Knigh—CE, CC, E, EL, IN, MP, MR, PR, PC, TC, TR
 *AMCON—American Condenser Corp.
AMERICAN CONDENSER CORP., 2508 S.
 Michigan Ave., Chicago, Ill., *Amcon—E, IN, PC, PR, TC, TR
 ATLAS CONDENSER PRODUCTS CO., 548 Westchester Ave., New York, N. Y.—E, PR
 *ATOMS—Sprague Products Co.
 BARKER & WILLIAMSON, Ardmore, Pa.—IN, TR
 BUD RADIO, INC., 5205 Cedar Ave., Cleveland, Ohio—TR
 CANADIAN MARCONI CO., 211 St. Sacramento St., Montreal, Can.—CC, E, EL, IN, TR

Preceding Listings in RADIO-CRAFT'S CLASSIFIED RADIO DIRECTORY

Sec. I, Oct. '40:

Antennas & Accessories
 Automatic Tuners & Parts
 Auto-Radio Controls
 Battery Chargers, Eliminators & Rectifiers
 Batteries, Dry & Wet
 Cabinets
 Coils & Transformers (R.F. & I.F.), & Accessories
 Condensers (Fixed)

Sec. II, Nov. '40:

Condensers (Variable)
 Crystals (Quartz)
 Dials & Parts
 Electric Fence Controllers
 Electric-Generating Machines
 Electronics
 Electronic Musical Instruments & Parts
 Frequency Modulation Equipment
 Hardware—Connectors & Misc. Parts
 Headphones
 Hearing-Aids
 Hearing-Aid Parts
 Insulation
 Intercommunicating Systems
 Line Filters

Sec. III, Dec. '40:

Magnets
 Metal & Special Fittings (for Radio)
 Metal, Ore & Oil Locators
 Microphones
 Noise Elimination Equipment
 Paint, Cement & Wax Products
 Plastics
 Plastic Molders
 Radio Logs, Maps & Globes
 Receiving Sets (including Adapters & Converters)
 Records & Record-Playing Equipment

Sec. IV, Jan. '41:

Recording Equipment
 Resistors & Volume Controls (Attenuators & Networks)
 Schools
 Service Manuals, Books & Magazines
 Servicing Equipment
 Sound Systems, Amplifiers & Accessories

Sec. V, Feb. '41:

Speakers (& Parts)
 Switches & Relays
 Television
 Test Equipment—Laboratory & Production
 Tools
 Transformers & Chokes
 Transmitters (& Equipment)

Sec. VI, March '41:

Tubes (& Parts)
 Vibrators
 Wire
 Literature

The above back-issues of *Radio-Craft* are available at the regular price of 25c per copy.

Next month: Section II of the Classified Radio Directory, revised, with new classifications, and new names and addresses added; and with obsolete listings removed. Reserve your copy, today, from your regular newsdealer.

CANADIAN RADIO CORP., LTD., 622 Fleet St., W., Toronto, Ont., Can.—E, EL, MR, PR
 THE ALLEN D. CARDWELL MFG. CORP., 81 Prospect St., Brooklyn, N. Y.—TR (air & coil)
CENTRALAB, DIV. OF GLOBE UNION, INC.,
 900 E. Keefe Ave., Milwaukee, Wis.—CE, CC
 CONDENSER PRODUCTS CO., 1375 N. Branch St., Chicago, Ill.—E, IN, PR, TC
 CONSOLIDATED WIRE & ASSOCIATED CORPS., 512 S. Peoria St., Chicago, Ill.—E, EL
 CONTINENTAL CARBON, INC., 1390 Lorain Ave., Cleveland, Ohio—PR, PC, TC, TR

CORNELL-DUBILIER ELEC. CORP., S. Plainfield, N. J.—CC, E, EL, IN, MP, MR, PR, TC, TR
 CRUMPACKER DISTRIB. CORP., 1801 Fannin St., Houston, Tex.—CC, E, EL, IN, MP, MR, PR, TR
 HAROLD DAVIS, INC., 428 W. Capital St., Jackson, Miss.—CC, E, EL, IN, MP, MR, PR, TC, TR
 TOBE DEUTSCHMANN CORPORATION, Canton, Mass.—E, IN, PR, PC, TR
 DOW RADIO SUPPLY CO., 1759 E. Colorado, Pasadena, Calif.—CC, E, EL, IN, MP, MR, PR, TC, TR
 THE ELECTRO MOTIVE MFG. CO., INC., Willimantic, Conn.—MR
 ERIE RESISTOR CORP., 644 W. 12th St., Erie, Pa.—CC, MP, MR, TC
 JOHN E. FAST & CO., 3123 N. Pulaski Ave., Chicago, Ill.—IN, PR, TC, TR
 FEDERATED PURCHASER, INC., 80 Park Place, New York, N. Y.—CE, CC, E, EL, MP, MR, PR, PC, TR
 FISCHER DISTRIB. CORP., 222 Fulton St., New York, N. Y.—CC, E, EL, IN, MP, MR, PR, TC, TR
 FONDA CORPORATION, 29 W. 57th St., New York, N. Y.—E, EL, IN, PC, TC
 GENERAL ELECTRIC CO., Schenectady, N. Y. & Bridgeport, Conn.—IN, PC, TC, TR
 EDWIN I. GUTHMAN & CO., INC., 400 S. Peoria St., Chicago, Ill.—MP, MR
 HAMMOND MANUFACTURING CO., Guelph, Ont., Can.—TR
 HARRISON RADIO CO., 12 W. Broadway, New York, N. Y.—CE, CC, E, EL, IN, MP, MR, PR, P, TC, TR
 HERBERT H. HORN, 1201 S. Olive St., Los Angeles, Calif.—CC, E, EL, MP, MR, PR
 ILLINOIS CONDENSER CO., 1160 N. Howe St., Chicago, Ill.—E, IN, PR
 INDUSTRIAL CONDENSER CORP., 4049 Diversey Ave., Chicago, Ill.—E, IN, PR, TC, TR
 INSULINE CORP. OF AMERICA, 30-30 Northern Blvd., Long Island City, N. Y.—CC, MP
 E. F. JOHNSON CO., Waseca, Minn.—TC
 *KNIGHT—Allied Radio Corp.
 *KOOLOHMS—Sprague Products Co.
 LAFAYETTE RADIO CORP., 100 6th Ave., New York, N. Y.—CC, E, EL, IN, MP, MR, PR, TC, TR
 M & H SPORTING GOODS CO., 512 Market St., Phila., Pa.—CC, E, EL, IN, MP, MR, PR, TC, TR
 THE MAGNAVOX COMPANY, INC., 2131 Buetter Rd. Ft. Wayne, Ind.—E
 MAJESTIC RADIO & TELEVISION CORP., 2600 W. 50th St., Chicago, Ill.—PM, PR
 P. R. MALLORY & CO., INC., 3029 E. Washington St., Indianapolis, Ind.—CC, E, EL, IN, MP, MR, PR, TC, TR
 MEISSNER MANUFACTURING CO., Mt. Carmel, Ill.—MP
 MICAMOLD RADIO CORP., 1087 Flushing Ave., Brooklyn, N. Y.—E, EL, MR, PR, TR
 JAMES MILLEN MFG. CO., INC., 150 Exchange St., Malden, Mass.—MP
 MIMS RADIO CO., P. O. Box 504, Texarkana, Ark.—IN
 MONTGOMERY WARD & CO., 619 W. Chicago Ave., Chicago, Ill., *Airline—E, EL, MP, MR, PR, TR
 THE MUTER COMPANY, 1255 S. Michigan Ave., Chicago, Ill.—CC
 NATIONAL COMPANY, INC., 61 Sherman St., Malden, Mass.—TR
NATIONAL UNION RADIO CORP., 57 State St., Newark, N. J.—E, EL, PR, TR
 OFFENBACH ELECTRIC CO., 1452 Market St., San Francisco, Calif.—CC, E, EL, IN, MP, MR, PR, TC, TR
 PHILCO RADIO & TELEVISION CORP., Tioga & "C" Sts., Phila., Pa.—CC, E, EL, IN, MP, MR, PR, TC
RADIO ELECTRIC SERVICE CO., INC., N. W.
 Cor. 7th & Arch Sts., Phila., Pa.—CC, E, EL, IN, MP, MR, PR, TC, TR
 RADIO EQUIPMENT CORP., 326 Elm St., Buffalo, N. Y.—CC, E, EL, IN, MP, MR, PR, TC, TR
 RADOLEK COMPANY, 601 W. Randolph St., Chicago, Ill.—CE, CC, E, EL, IN, MP, MR, PR, PCTR
 RCA MANUFACTURING CO., INC., Camden, N. J.—CC, MP, MR, PR, TR
 SANGAMO ELECTRIC CO., Springfield, Ill.—MR, TR
 MAURICE SCHWARTZ & SON, 710-712 Broadway, Schenectady, N. Y.—CC, E, EL, IN, MP, MR, PR, TC, TR
 SEATTLE RADIO SUPPLY CO., INC., 2117 2nd Ave., Seattle, Wash.—CE, E, EL, IN, MP, MR, PR, TR
 *600 LINE—Sprague Products Co.
 SOLAR MANUFACTURING CORP., Ave. A & 25th St., Bayonne, N. J.—CC, E, EL, IN, MP, MR, P, PR, TC, TR
 SPRAGUE PRODUCTS CO., N. Adams, Mass., *600 Line", "Atoms", "Koolohms", "Telohmite"—CC, E, EL, IN, MP, MR, PR, PC, TC, TR
 STROMBERG-CARLSON TELEPHONE MFG. CO., 100 Carlson Rd., Rochester, N. Y.—PR
 SUN RADIO CO., 212 Fulton St., New York, N. Y.—CC, E, EL, IN, MP, MR, PR, TC, TR
 TELERADIO ENGINEERING CORP., 484 Broome St., New York, N. Y.—CC, MP, MR, TC
 *TELOHMIT—Sprague Products Co.
 TILTON ELECTRIC CORP., 15 E. 26th St., New York, N. Y.—E, EL, PR
 TRY-MO RADIO CO., INC., 85 Cortlandt St., New York, N. Y.—CE, CC, E, EL, IN, MP, MR, PR, P, PC, TC, TR
 WESTINGHOUSE ELEC. & MFG. CO., E. Pittsburgh, Pa.—PC, TR

Please say you saw it in the Radio-Craft "Classified Radio Directory"

CLASSIFIED RADIO DIRECTORY

FREE - REAL ELECTROPLATING OUTFIT



**Now -
You Can ELECTROPLATE
EASILY WITH A BRUSH**

SOMETHING new for radio men—something which gives you the opportunity to make additional profits—or to improve your type of service. Here's an **ELECTROPLATING KIT** amazingly simple to operate—you just Electroplate with a Brush!

NOT A TOY!

Electroplate for profit, hundreds of things in the household—ashtrays, fixtures, water faucets, worn brackets, door knobs, musical instruments, jewelry and silverware and other articles. It's an indispensable piece of equipment—plate articles in hotels, apartments, office buildings, medical and dental offices, factories, schools, laboratories, etc. Exactly the same outfit (but larger) is used professionally by electroplaters, radio service men, automobile repair shops, etc. Requires one single dry cell 1 1/2-volt battery to operate.

You can electroplate tarnished receiver parts, earphones, contacts, worn radio parts and accessories and display chassis. Put this **REAL ELECTROPLATING KIT** to use immediately—make it the most useful article in your shop or laboratory. And you can get it absolutely **FREE** (except for slight mailing cost).

Subscribe today to **RADIO-CRAFT** for One Year (12 issues) and receive absolutely **FREE** this **ELECTROPLATING KIT**. New subscribers are accepted or extend your present subscription twelve months. Mail remittance of \$2.00 (plus 10c for shipping charge on kit) to the publisher (Canada and foreign \$2.85). You will receive your **FREE, REAL ELECTROPLATING OUTFIT** by return mail. Use coupon below to enter subscription.

RADIO-CRAFT

20 Vesey Street New York, N. Y.

RADIO-CRAFT RC-41
20 Vesey Street, New York, N. Y.

Gentlemen: Enclosed find my remittance of \$2.00 for which enter my subscription to **RADIO-CRAFT** for One Year (12 issues). Send me **FREE, REAL ELECTROPLATING OUTFIT** (Canada and foreign \$2.85). In U. S. add only 10c additional to cover shipping charges on kit.

New Subscriber Extend Present Subscription

Name

Address

City

State

(Send remittance by check, money order or unused U. S. Postage stamps. Register letter if you send cash or stamps.)

CONDENSERS, VARIABLE



Trimmer (air)	AT
Trimmer (ceramic)	CT
Trimmer (mica)	MT
Tuning (receiver)	R
Tuning (transmitter)	T
Padding	P

*"AIRLINE"—Montgomery Ward & Co. ALLIED RADIO CORP., 833 W. Jackson Blvd., Chicago, Ill. *"Knight"—AT, MT, P, R, T AMERICAN RADIO HARDWARE CO., INC., 476 Broadway, New York, N. Y.—AT BARKER & WILLIAMSON, Ardmore, Pa.—T BUD RADIO, INC., 5205 Cedar Ave., Cleveland, Ohio—AT, R, T CANADIAN MARCONI CO., 211 St. Sacramento St., Montreal, Can.—T THE ALLEN D. CARDWELL MFG. CORP., 81 Prospect St., Brooklyn, N. Y.—AT, R, T CARRON MANUFACTURING CO., 415 S. Aberdeen St., Chicago, Ill.—AI, MI, P, K CENTRALAB, DIV. OF GLOBE UNION, INC., 900 E. Keefe Ave., Milwaukee, Wis.—CT, P CRUMPACKER DISTRIB. CORP., 1801 Fannin St., Houston, Tex.—MT, R HAROLD DAVIS, INC., 428 W. Capital St., Jackson, Miss.—AT, MT, R, T DOW RADIO SUPPLY CO., 1759 E. Colorado, Pasadena, Calif.—AT, MT, R, T THE ELECTRO MOTIVE MFG. CO., INC., Willimantic, Conn.—AT, MT ERIE RESISTOR CORP., 644 W. 12th St., Erie, Pa.—MT FEDERATED PURCHASER, INC., 80 Park Place, New York, N. Y.—AT, MT, R, T FISCHER DISTRIB. CORP., 222 Fulton St., New York, N. Y.—AT, MT, R, T GENERAL INSTRUMENT CORP., 829 Newark Ave., Elizabeth, N. J.—R EDWIN I. GUTHMAN & CO., INC., 400 S. Peoria St., Chicago, Ill.—MT HAMMARLUND MFG. CO., INC., 424 W. 33rd St., New York, N. Y.—AT, MI, P, R, T HAMMOND MANUFACTURING CO., Guelph, Ont., Can.—T HARRISON RADIO CO., 12 W. Broadway, New York, N. Y.—AT, MT, R, T HEINTZ & KAUFMAN, LTD., So. San Francisco, Calif.—T INSULINE CORP. OF AMERICA, 30-30 Northern Blvd., Long Island City, N. Y.—MT, R, T E. F. JOHNSON CO., Waseca, Minn.—T *KNIGHT—Allied Radio Corp. LAFAYETTE RADIO CORP., 100 6th Ave., New York, N. Y.—AT, MT, P, R, T M & H SPORTING GOODS CO., 512 Market St., Phila., Pa.—AT, MT, R, T MAJESTIC RADIO & TELEVISION CORP., 2600 W. 50th St., Chicago, Ill.—MT MEISSNER MANUFACTURING CO., Mt. Carmel, Pa.—AT, MT, P, R JAMES MILLEN MFG. CO., INC., 150 Exchange St., Malden, Mass.—AT, MT, R, T J. W. MILLER CO., 5917 S. Main St., Los Angeles, Calif.—MT MONTGOMERY WARD & CO., 619 W. Chicago Ave., Chicago, Ill. *"Airline"—AT, MT, R, T NATIONAL COMPANY, INC., 61 Sherman St., Malden, Mass.—AT, MT, R, T OAK MANUFACTURING CO., 1260 Clybourn Ave., Chicago, Ill.—R OFFENBACH ELECTRIC CO., 1452 Market St., San Francisco, Calif.—AT, MT, R, T PHILCO RADIO & TELEVISION CORP., Tioga & "C" Sts., Phila., Pa.—AT, MT, P, R RADIO CONDENSER CO., Camden, N. J.—AT, R RADIO ELECTRIC SERVICE CO., INC., N. W. Cor. 7th & Arch Sts., Phila., Pa.—AT, MT, R, T RADIO ENGINEERING LABS., INC., 35-54 36th St., Long Island City, N. Y.—T RADIO EQUIPMENT CORP., 326 Elm St., Buffalo, N. Y.—AT, MT, R, T RADOLEK COMPANY, 601 W. Randolph St., Chicago, Ill.—AT, MT, P, R, T RCA MANUFACTURING CO., INC., Camden, N. J.—MT, P, R ROGERS-MAJESTIC CORP., LTD., 622 Fleet St., Toronto, Can.—MT MAURICE SCHWARTZ & SON, 710-712 Broadway, Schenectady, N. Y.—AT, MT, R, T SEATTLE RADIO SUPPLY CO., INC., 2117 2nd Ave., Seattle, Wash.—AT, MT, R, T SOLAR MANUFACTURING CORP., Ave. A & 25th St., Bayonne, N. J.—MT, P SUN RADIO CO., 212 Fulton St., New York, N. Y.—AT, MT, R, T TELERADIO ENGINEERING CORP., 484 Broome St., New York, N. Y.—AT, MT TRY-MO RADIO CO., INC., 85 Cortlandt St., New York, N. Y.—AT, MT, R, T UNITED SCIENTIFIC LAB., INC., 440 Lafayette St., New York, N. Y.—AT WESTINGHOUSE ELEC. & MFG. CO., E. Pittsburgh, Pa.—T

CRYSTALS (Quartz)



Amateur	A
Blanks	B
Broadcast	BC
Frequency standard	FS
Holders	H
I.F. filter	IF
Supersonic	S
Temperature-control ovens	TO

*"AIRLINE"—Montgomery Ward & Co. ALLIED RADIO CORP., 833 W. Jackson Blvd., Chicago, Ill. *"Knight"—A, B, H *ALSIMAG—American Lava Corp. AMERICAN LAVA CORP., Cherokee Blvd. & Manufacturers Rd., Chattanooga, Tenn. *"AlSiMag"; "Lava"—H AMERICAN RADIO HARDWARE CO., INC., 476 Broadway, New York, N. Y.—H *BLILEY—Bliley Electric Co. BLILEY ELECTRIC CO., 200 Union Sta. Bldg., Erie, Pa. *"Bliley"—A, BC, FS, H, IF, S, TO WM. W. L. BURNETT RADIO LAB., 4814 Idaho St., San Diego, Calif.—BC, FS, H, TO CANADIAN MARCONI CO., 211 St. Sacramento St., Montreal, Can.—BC, FS, H, IF, TO HAROLD DAVIS, INC., 428 W. Capital St., Jackson, Miss.—A, BC DOOLITTLE RADIO, INC., 7421 Loomis Blvd., Chicago, Ill.—TO DOW RADIO SUPPLY CO., 1759 E. Colorado, Pasadena, Calif.—A, BC FEDERATED PURCHASER, INC., 80 Park Place, New York, N. Y.—A, B, BC, FS, H, IF, TO GENERAL ELECTRIC CO., Schenectady, N. Y. & Bridgeport, Conn.—A, BC, FS, H, IF, TO HARRISON RADIO CO., 12 W. Broadway, New York, N. Y.—A, BC, FS, H, IF, TO HARVEY RADIO LABS., INC., 25 Thorndike St., Cambridge, Mass.—A, BC HARVEY-WELLS COMMUNICATIONS, INC., North St., Southbridge, Mass.—A, BC, FS, H, TO H-B INSTRUMENT CO., INC., 2518 N. Broad St., Phila., Pa.—TO HIPOWER CRYSTAL CO., SALES DIV., 2020 Engineering Bldg., Chicago, Ill.—A, BC KAAR ENGINEERING CO., 619 Emerson St., Palo Alto, Calif.—A, BC *KNIGHT—Allied Radio Corp. LAFAYETTE RADIO CORP., 100 6th Ave., New York, N. Y.—A, BC *LAVA—American Lava Corp. FRED M. LINK, 125 W. 17th St., New York, N. Y.—A, BC M & H SPORTING GOODS CO., 512 Market St., Phila., Pa.—A, BC MEISSNER MANUFACTURING CO., Mt. Carmel, Ill.—TO AUGUST E. MILLER, 9226 Dudson Blvd., North Bergen, N. J.—A, B, BC, FS, H, IF, TO ELMER E. MILLS CORP., 612 W. Van Buren St., Chicago, Ill.—BC MONTGOMERY WARD & CO., 619 W. Chicago Ave., Chicago, Ill. *"Airline"—A, H, IF NORTHERN ELECTRIC CO., LTD., 1261 Shearer St., Montreal, Que., Can.—A, BC OFFENBACH ELECTRIC CO., 1452 Market St., San Francisco, Calif.—A, BC PETERSEN RADIO CO., 205 N. 17th St., Council Bluffs, Iowa—A, BC, H PRECISION CRYSTAL LABS., Springfield Airport, Springfield, Mass.—A, B, BC, FS, H, TO PRECISION PIEZO SERVICE, 427 Asia St., Baton Rouge, La.—A, B, BC, FS, H, TO PREMIER CRYSTAL LABS., INC., 53 Park Row, New York, N. Y.—A, B, BC, FS, H, IF, TO RADIO ELECTRIC SERVICE CO., INC., N. W. Cor. 7th & Arch Sts., Phila., Pa.—A, BC RADIO EQUIPMENT CORP., 326 Elm St., Buffalo, N. Y.—A, BC RADOLEK COMPANY, 601 W. Randolph St., Chicago, Ill.—A, H RCA MANUFACTURING CO., INC., Camden, N. J.—A, BC, FS, H MAURICE SCHWARTZ & SON, 710-712 Broadway, Schenectady, N. Y.—A, BC SCIENTIFIC RADIO SERVICE, 124 Jackson Ave., University Pk., Hyattsville, Md.—A, B, BC, FS, H, IF SEATTLE RADIO SUPPLY CO., INC., 2117 2nd Ave., Seattle, Wash.—A, BC, FS, H, IF, TO STANDARD PIEZO CO., Cedar & Louther Sts., Carlisle, Pa.—A, BC SUN RADIO CO., 212 Fulton St., New York, N. Y.—A, BC TAYLOR AIRPHONE PRODUCTS, Hangar 15, Long Beach Airport, Long Beach, Calif.—A, BC TRY-MO RADIO CO., INC., 85 Cortlandt St., New York, N. Y.—A, B, BC, FS, H, IF, TO VALPEY CRYSTALS, P. O. Box 321, Holliston, Mass.—A, B, BC, FS, H, IF, TO WILCOX ELECTRIC CO., INC., 40th & State Line, Kansas City, Mo.—A, BC

HANDY TESTER

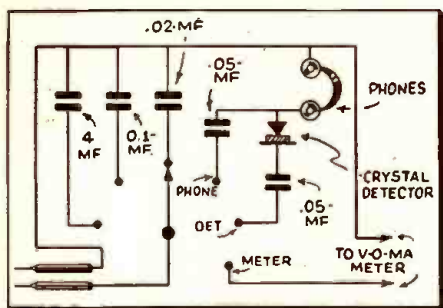

● THE handy tester here diagrammed is a multi-service device which saves time and labor in checking for open bypass condensers, making continuity tests, and for use as a stage analyzer.

The selector switch may be of the 6-position, single-gang type; or, more versatility can be obtained by using a 12-position, single-gang selector switch and adding condensers to suit individual preferences.

If condensers of high working-voltage rating are used, the device becomes useful as an emergency condenser replacement box.

MANUEL MADRIDANO,
Sta. Cruz,
Manila, Philippine Islands.

BASS RE-INFORCEMENT FOR ANY RADIO SET

● FIDELITY of tone is one of the major selling features of the newer sets, and this fidelity of tone introduces to the user the possibilities of adequate, faithful bass response without sacrifice of any of the higher frequencies. The larger, more expensive sets accomplish this rendition of bass through the use of a separate amplifying channel for bass frequencies only.

Such a channel can be very simply and inexpensively added to almost any radio set that is not too old. The necessary parts are few, and the results are astounding; in fact, I have sold many owners of sets 3 and 4 years old, who were ready to trade their sets in on new ones, on the idea of such an installation after a very simple demonstration. (Why not sell 'em the new set?!—Ed.)

A glance at the diagram will show that the idea is merely a high-gain audio stage so filtered as to pass practically nothing but the lower bass register, amplified. The amount of amplification is controlled by the variable high resistance in the grid circuit, and in actual use this control is used as a bass tone control. The bass stage is wired into the set in parallel with the 1st audio stage of the set.

There is nothing difficult or special about the construction of the unit. It may be mounted on a small metal sub-base and fastened close to the radio chassis, or preferably, it may be built directly upon the radio chassis, if there is sufficient space.

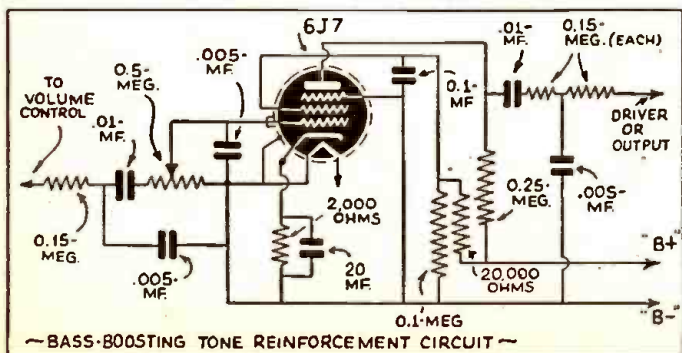

Diagram showing how William J. Vette of Denver, Colorado, reinforces bass response in any radio receiver.

The diagram shows a metal tube, a 6J7, in use—in the event the radio set uses glass tubes with 2.5 volt filaments, it will be necessary to substitute a 6-prong socket and a 57 type tube.

The high "B" voltage should be adjusted so as to supply about 120 volts to the plate and about 65 volts to the screen-grid.

You will find in using this unit, when the bass control is advanced, the bass response increases to the point where the music sounds rich and natural, without any loss of higher frequencies as is the case with an ordinary tone control. You will find that if you will build up a unit to use for demonstrating purposes, your service customers will jump at the possibility of having their own radio receivers sound as good.

- Three 0.15-meg. 150,000-ohm 1/2-watt resistors;
- One 0.1-meg. 100,000-ohm 1/2-watt resistor;
- One 0.25-meg. 250,000-ohm 1/2-watt resistor;
- One 20,000-ohm 1/2-watt resistor;
- One 2,000-ohm 1/2-watt resistor;
- One 0.5-meg. 500,000-ohm variable resistor;
- Three 0.005-mf., 400-volt condenser;
- Two 0.01-mf., 400-volt condenser;
- One 0.1-mf. 400-volt condenser;
- One 20-mf., 25-volt dry electrolytic condenser;
- *One small grid clip;
- *One 8-prong octal socket;
- *One 6J7 tube;
- Hookup wire, hardware, etc.

*(See text; these 3 items may be substituted.)

WILLIAM J. VETTE,
Denver, Colorado

WIRE-SKINNING PLIERS

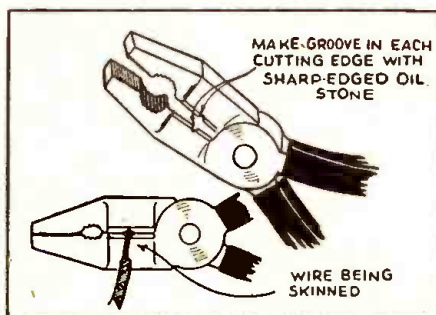

● TO strip the insulation from the ends of wires, take a sharp-edged oilstone and stone a small groove in each cutting edge, just deep enough so that when the jaws of the cutter are tightly closed, they will not cut the bare wire of the size you intend to use.

To skin the wire, place the end of the wire to be stripped at the notched point and pull. The insulation will be cleanly stripped off.

The best location for these small notches is near the pliers joint so that the ends of the cutting blades will be available for ordinary use.

A. C. CARTER,
Cambridge, New Zealand

FREE!
RADOLEK'S
NEW 1941
RADIO
PROFIT
GUIDE

Bargains!
Galore Like These.

PORTABLE RECORDER and Play Back Combination
\$19.75

A complete self-contained Portable Recorder and Electric Phonograph. Nothing else to buy. Consists of combination record cutter and playback pickup, constant speed 78 RPM motor with weighted turntable, built in 3 tube amplifier complete with tubes, volume control, PM dynamic speaker, crystal microphone and desk stand. Entire unit housed in alligator grain leatherette covered case, size 13" x 13" x 7". Uses standard acetate discs and needles. For 110 volt 60 cycle AC operation.

BASIC RECORDER
\$7.25

Same combination recording and playback chassis as used in above unit. For built-your-own recorders or for use in conjunction with radio receiver. Includes combination cutting head and playback pickup with feed mechanism, constant speed 78 RPM motor with 8 1/2" weighted turntable and needle cup installed on 3/4" leatherette covered mounting board ready to use with your own microphone and recording amplifier. Mounting space required 12 1/2" x 12 1/2". Depth, 3" below board and 3 1/2" above board. For 110 volt 60 cycle AC operation.

PROFESSIONAL TYPE 10" RECORDING DISCS
only 19¢

Made by foremost manufacturer. Proven equal or superior to any discs of this type regardless of cost. These blanks have very slight imperfections but guaranteed to make perfect recordings or your money back. Coated on both sides—heavy metal base—non-inflammable. Big savings!

6" Discs—10¢; 8"—14¢; 10"—19¢; 1¢ less in 25 lots. Send no money—shipped C.O.D. plus postage.

EVERYTHING NEW IN RADIO AT BARGAIN PRICES!

Shows hundreds and hundreds of up-to-the-minute radio parts, sets, accessories, ham gear, electric appliances and supplies. Indispensable to every amateur, experimenter, set builder, sound engineer and service man. Keep up with radio and all its phases—send for the big FREE Radolek Profit Guide now! DON'T WAIT—SAVE MONEY AT RADOLEK.

SEND TODAY! PASTE ON A POST CARD

RADOLEK CO., Dept. C-53
601 W. Randolph St., Chicago, Ill.

Send FREE Catalog.

Ship PORTABLE RECORDER C.O.D. \$19.75 Plus Postage.

Ship BASIC RECORDER C.O.D. \$7.25 Plus Postage.

Ship _____ Discs, Size _____ inches, C.O.D. Plus Postage.

Name _____
Address _____

Index to advertisers

PUBLISHERS

Amplifier Co. of America.....	609
Audel, Publishers.....	582
Data Print Co.....	582
Miller, Wayne.....	583
National Plans Inst.....	599
Radcraft Publications, Inc.....	584, 614
Radio & Technical Pub. Co.....	599
Radiolab Publishing Co.....	583
Supreme Publications.....	618
Technifax.....	582, 626

RADIO PARTS

Aerovox Corporation.....	601
Amperite Co.....	Inside Front Cover
Hammarlund Mfg. Co.....	618
Meissner Mfg. Company.....	579
National Union Radio Corp.....	Back Cover
Ohmite Mfg. Company.....	619
Solar Mfg. Corp.....	612

RADIO SETS

Midwest Radio Corp.....	582
RCA Manufacturing Co., Inc.....	591

RADIO SUPPLY HOUSES

Allied Radio Corp.....	623
Burstein-Applebee Co.....	618
Federated Purchaser, Inc.....	625
Hudson Specialties Co.....	628
Radolek Co.....	639
Sears, Roebuck & Company.....	581

SCHOOLS

Capitol Radio Eng. Inst.....	582
Coyne Radio School.....	583
Lincoln Engineering School.....	580
National Radio Institute.....	577
National Schools.....	580
Port Arthur College.....	580
Radio Training Assoc.....	580
RCA Institutes.....	580
Sprayberry Academy of Radio	
Inside Back Cover	

SOUND & RECORDING EQUIPMENT

Amplifier Co. of America.....	622
General Industries Co.....	609
Jensen Radio Mfg. Co.....	603
John Meck Industries.....	622
Miles Reproducer Co.....	599
National Recording Supply Co.....	622
Regal Amplifier Mfg. Corp.....	607
University Laboratories.....	609

TEST EQUIPMENT

Radio City Products Co.....	598
Readrite Meter Works.....	599
Supreme Instruments Corp.....	597
Triplet Electrical Instrument Co.....	611
Weston Elec. Instrument Corp.....	601

TUBES

Hygrade Sylvania Corp.....	593
----------------------------	-----

MISCELLANEOUS

Atlas Press Co.....	612
Classified Section.....	630
Flight Magazine.....	631
Foredom Electric Co.....	597
Kato Engineering Co., Inc.....	597
Lancaster, Allwine & Rommel.....	582
National Fluorescent Sales & Service Co.....	622
Onan, D. W., & Sons.....	618
Premium Distributing Service.....	630
Radio Servicemen of America, Inc.....	632
Remington Rand, Inc.....	606
Walter L. Schott Co.....	612
Woodstock Typewriter Co.....	622

(While every precaution is taken to insure accuracy, we cannot guarantee against the possibility of an occasional change or omission in the preparation of this index.)

THE RADIO AMATEUR'S HANDBOOK—1941, 18th Edition (Revised). Published by American Radio Relay League. Paper covers, size 9½ x 6½ ins., profusely illustrated, 552 pages. Price \$1.

The 18th Edition of this standard manual of amateur ham-radio communications includes a new book-edge indexing system and a special catalog section. Both are of interest to technicians who wish to locate articles or products in minimum time.

The Handbook continues to be the best book value in the radio field. A wealth of material is contained in 32 chapters, grouped as follows: Introduction, Principles and Design, Construction and Adjustment, Antennas, Ultra-High Frequencies, Operating and Traffic Handling. The most modern practices of amateur radio communication are described in detail.

FUN WITH A RECORDER. Published by Audio Devices, Inc. Paper covers, size 8 x 5½ ins., 167 pages. Price \$1.

This book contains 30 amusing skits in radio-script form. Covering a variety of human subjects, they appeal to most embryo "actors," young and old, who may wish to take a hand at disc recording.

Each skit is cued for sound effects with complete instructions on how to produce them. Servicemen-dealers might do well to include "Fun With a Recorder" as a premium on the purchase of a radio set having sound recording facilities. This book will help you make your disc sound-recorder the life of the party.

HOW TO MAKE GOOD RECORDINGS. Published by Audio Devices, Inc. Hard paper covers, size 5¼ x 8 ins., profusely illustrated, 128 pages. Price \$1.00.

This book may well be called "The Complete Handbook for the Every-Day Recordist."

Home recordists, teachers, musicians, even sound engineers who already have a wide acquaintance with (disc) recording will find that the information this book contains fills gaps in their knowledge.

Written in non-technical style, the subject matter covers a wide range of subjects as for example, how to choose a recorder, cutting and playing needles, mike technique, putting together a show, recording sound effects, recording for home movies, common difficulties and their remedies, and many others.

THE CALCULATION AND DESIGN OF ELECTRICAL APPARATUS, 2nd Edition (Revised), by W. Wilson. Published by Chapman & Hall, London, England; available from Sherwood Press, Edgewater Branch, Cleveland, Ohio. Cloth covers, size 5 x 7½ ins., 220 pages. Price \$2.50.

This book forms a comprehensive treatise on the physical principles and mathematical formulas of electromagnets, meters, instruments. The numerous tables are worth the price of the book.

This book is of particular value to student engineers. It should be noted that the treatment is mainly mathematical, and is prepared in school textbook style (problems and answers, etc.).

ELECTRICAL MEASUREMENTS IN PRINCIPLE AND PRACTICE, by H. Cobden Turner and E. H. W. Banner. Published by Chapman & Hall, London, England. Cloth covers, size 5½ x 8½ ins., 350 pages, well illustrated. Price \$1.50.

This book has been written primarily for technicians who want applicational information concerning electrical measurement devices but who do not require a textbook involving the mathematical treatments which might be required by students and research workers.

The subject matter deals in detail with the common measurements of current, voltage, power and resistance, and with the application of electrical devices to the measurement of speed, temperature, illumination, etc., and to many miscellaneous measurements.

Radio men will be interested to note that this book also gives attention to the more specialized types of measurement involving the use of D.C. and A.C. potentiometers, A.C. bridges, vacuum tubes, and the oscilloscope.

RADIO TRAILBLAZING, by B. H. Darrow. Published by College Book Company. Cloth covers, size 5¼ x 7¼ ins., 137 pages. Price \$2.

The founder of the "Little Red Schoolhouse of Radio"—WLS, Chicago, verbally paints the picture of this program in a brief history of

the Ohio School of the Air and its implications for educational broadcasting.

Chapter headings: Chapter I, Origin and Establishment; Chapter II, The Period of Substantial Development; Chapter III, The Depression Makes Itself Felt; Chapter IV, The Gradual Extension of Services; Chapter V, New Difficulties Arise; Chapter VI, Some Personal Conclusions About Educational Broadcasting.

RADIO AND THE PRINTED PAGE, by Paul F. Lazarsfeld. Published by Duell, Sloan & Pearce, Inc. Cloth covers, size 5¼ x 8½ ins., 354 pages. Price \$4.

The Director of the Office of Radio Research here presents a thorough-going study of Radio and the Press.

This book is intended for the use of persons in commercial broadcasting but it also has lay interest in its dramatically presented survey of radio broadcasting as a new factor in the life of America. The book contains, among other contributions, the following: "The Importance of Being Earnest, Why Do People Like a Program?", "The Future of Serious Listening, To Read or Not to Read, Radio and the Printed Page as Sources of News, For Further Details . . ."

48 MILLION HORSES, by Humphrey B. Neill. Published by J. B. Lippincott & Co. Cloth covers, size 6 x 9¼ ins., 241 pages, well illustrated. Price \$2.50.

Here is a book of non-technical and semi-technical interest, divided into 6 parts—Energy, Light and Comfort, Industry, Tele-Magic, Transportation, and Looking Ahead.

It tells in romantic fashion of the progress of Electricity since Thomas Edison in 1882 opened the Pearl Street Central Station in New York City.

The title is a reference to the present-day capacity of America in terms of the production of electrical horsepower. The part, "Looking Ahead" contains an interesting chapter, "You and I and the Electron" by Dr. Willis R. Whitney, vice-President in charge of Research, G.E. Co.

RCA SERVICE NOTES FOR 1939—RADIO RECEIVERS, VICTROLAS, TELEVISION, TEST EQUIPMENT. Published by RCA Mfg. Co. Cloth covers, size 8½ x 11 ins., 406 pages. Price \$1.50.

This is the largest and most complete bound volume of "Service Notes" ever issued by RCA Victor. It covers not only 1939 radio and radio-phonograph instruments, but also makes available to dealers and Servicemen technical data on a number of 1940 models. The book contains over 150 circuits together with servicing data.

A master index contains reference to service data in this and all the preceding issues of "Service Notes" in this series. It is of interest to note that the book includes instruction—service notes on RCA test equipment. Also bound into the volume is the 48-page Chanalyst instruction book.

RADIO LABORATORY JOB SHEET MANUAL, Radiolab Publishing Company, Brooklyn, New York. Composition covers, size 11½ x 8½ ins., profusely illustrated, 78 pages. Price \$1.80.

This new spiral-bound publication is a "basic course"—an instruction manual for practical radio projects. It contains information of interest to nearly every radio technician, in addition to its direct value to students.

The thousands of instructors throughout the U.S. who have recently been given the job of teaching Radio under the National Defense plan will welcome this working outline by an author who writes from the dual vantage points of teacher and technician.

This book employs the time-proven technique of "building to learn." Construction experiments lead the student from the elements of electricity to the construction and operation of a complete radio receiver.

The plan may be divided roughly as follows: Electrical Fundamentals—Exps. 1-4; Electricity and Sound—Exps. 5-7; Radio-Frequency Phenomena—Exps. 8-9; Simple Vacuum-Tube Operation—Exps. 10-13; A.C. Power Apparatus—Exps. 14-17; A.C. Receivers—Exps. 18-20; Additional Construction Projects—Exps. 21-24.

The latter chapter includes construction information on a T.R.F. Receiver, R.F. and A.F. Signal Generators, and a Superhet. Receiver. Of interest to those who wish to learn telegraphy are the Morse Code table and Radio Symbols chart.

FULL EQUIPMENT

Included WITH

SPRAYBERRY RADIO TRAINING!

Experience Easily Acquired at Home!

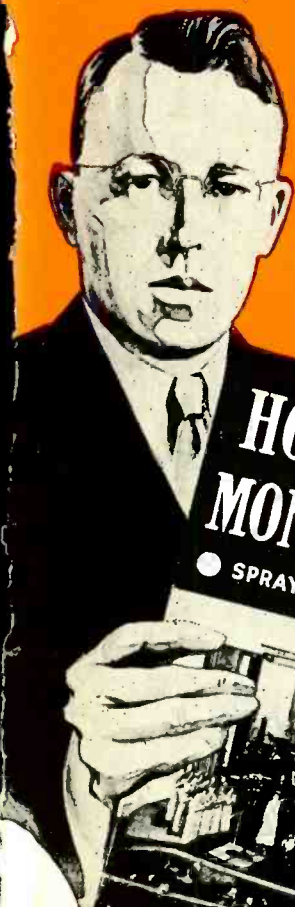

HOW TO MAKE MONEY IN RADIO
 SPRAYBERRY ACADEMY OF RADIO



146 RADIO PARTS

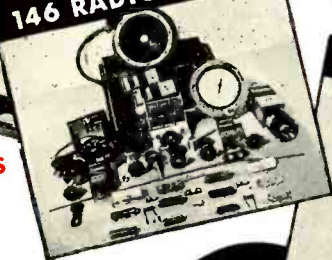

RADIO TOOLS



TESTER-ANALYZER



READ WHAT THESE FELLOWS SAY ABOUT THE NEW PRACTICAL SPRAYBERRY TRAINING



"GROSSED BETWEEN \$150 AND \$200"

"Since finishing your training I've started in the Radio repair business. I have about all the work I can take care of. I have grossed between \$150 and \$200 in the last few months in my spare time. I think your Course is 'tops'." W. Francis Waseka, Fountain City, Wisconsin.

"SALARY HAS INCREASED"

"Your Radio training has made it possible for me to make more money. My salary has increased from \$40.00 to around \$50.00 per week. I now have about all the Radio repair work I can handle." Asa Smith, P. O. Box 528, Fort Leavenworth, Ky.



"MADE AS MUCH AS \$8 A DAY"

"The instruments you have sent me helped me in solving Radio problems. I am building up my business by using all your methods, have made as much as \$8 in one day. L. R. Lanono, 316 Dudley Street, Providence, R. I.



Cash In on Radio's Rich Opportunities

No matter if you desire to BE YOUR OWN BOSS in your own business or hold down a good job in Radio, my Training will give you the useful information and knowledge to win success. Days of delay mean Precious time wasted. Start training for a money-making Radio career—right now.

REMEMBER —THE SPRAYBERRY COURSE IS SOLD UNDER A MONEY-BACK AGREEMENT



EARN WHILE YOU LEARN

My BUSINESS BUILDERS show you how to put your equipment to actual use in handling money-making Radio Service Jobs shortly after you begin training.

Learn More About the SPRAYBERRY Method and How Easy It Is to Start
 The complete details of my fundamental Course and Advanced Training Course . . . all features are fully described in my new, valuable 62-page FREE Book. Send for your copy. No obligation.

No Previous Experience Needed

It makes no difference what your education has been. . . can fit you quickly for a good-paying Radio job. I make it easy for you to grasp Radio principles and remember them. Your success is my full responsibility.

OVER 100 EXPERIMENTS

plus Many Other Special Features

ALL DESIGNED TO HELP YOU MAKE FAST PROGRESS!

SPRAYBERRY Training starts right at the beginning of Radio . . . unfolds each subject in a simplified, logical, understandable style. You easily learn Television Frequency Modulation, Signal Tracing, Mobile Radio (Auto-Tank), Aviation Radio, Electronics, Facsimile Radio, Radio Set Repair and Installation Work. You learn quickly in your spare hours . . . AT HOME OR AT CAMP.

Training Prepares You for a Business of Your Own . . . Or Good Radio Jobs at Excellent Pay!

The great, fascinating and progressive field of Radio and Television offers many opportunities to the man who wants to get ahead. There is good money to be made. My Training is designed to give you quick access to these opportunities. SPRAYBERRY Methods are thorough and practical. Your Training will not interfere with your present work.

You Get Professional Test Equipment plus Experimental Outfits!

. . . Includes 146 RADIO PARTS for building a complete Receiver, RADIO TOOLS and a modern TESTER-ANALYZER. You also receive 8 BIG SHIPMENTS OF RADIO EQUIPMENT for conducting actual experiments with your own hands. I show you how to create Radio defects . . . how to correct them. This practical "beforehand" experience will come in handy again and again when you are called on to do actual Radio repair work later on.

All Equipment Becomes Your Personal Property

DON'T DELAY! ACT NOW!

SPRAYBERRY ACADEMY OF RADIO

F. L. Sprayberry, Pres.
 420-D University Place, N. W.
 Washington, D. C.

Please send my FREE copy of "HOW TO MAKE MONEY IN RADIO."

Name Are

Address

City State

Tear off this coupon, mail in envelope or paste on penny postcard.

RUSH THIS COUPON for BIG FREE BOOK
 GIVING COMPLETE FACTS



Over 50,000 pieces of test equipment given away **FREE**

A CROSS SECTION OF NATIONAL UNION'S Honor Roll of Service Dealers

RALPH M. BOLICK, Bolick Nat. & Elec., Neosho, Mo.—Have had 20 equipment agreements during the past 7 years. I like to do business with N. U. for I find N. U. products and promotion helps outstandingly.

20 Contracts



41 Contracts

LOUIS E. CONNER, Radio Serv. Manager, Piper & Tait, Seattle, Wash.—After using thousands of N. U. tubes during the past seven years we find that we have had fewer replacements than on any other make. Most of our equipment has been secured the N. U. way.



15 Contracts



E. J. MAGINOT, Boston, Mass. In my opinion, and for the opinion of many other service engineers with whom I am associated, N. U. enjoys a prestige which needs no apology. Modern radio sets demand modern testing equipment. N. U. supplies it the easy way.

14 Contracts

J. G. COONEY, Cooney Radio Co., St. Louis, Mo.—Thanks to N. U. Equipment Deals my shop is one of the most completely equipped testing laboratories in the city. I find N. U. products are the quality products in the industry and continually recommend them to other dealers.



CLARENCE E. ESTELL, The Flatt Shop, Lima, Ohio—I believe N. U. equipment deals are the biggest contribution any manufacturer has ever offered to the radio service profession. In spite of cut-throat competition I sell at full list price because I can offer more for the money.

15 Contracts



J. E. STAGE, Longview Radio Sales & Service Co., Longview, Wash.—Think your Free Equipment Plan great—Have signed 23 N. U. Equipment Deals—have been using N. U. program 9 years. N. U. tubes all check alike—rarely have to make replacements.

23 Contracts

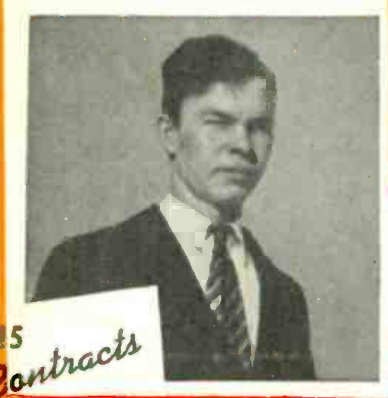

15 Contracts

VERNON M. HOOK, Barre, Vermont—N. U. has something in Free Equipment Deals that no other manufacturer can offer—One of the largest items of expense to the dealer is up-to-date test equipment—What way could be easier than selling N. U. products?



29 Contracts

MATHEW J. BERLOWITZ, Juncos Radio Shop, Milwaukee, Wisconsin—I find in checking my records I signed 29 contracts. There is no better way for a serviceman to painlessly acquire good service equipment. In my 10 years of exclusive dealing with N. U. their products have always been satisfactory.

You too can have the "Best Equipped Shop in Town"—See your N. U. Distributor or Write

NATIONAL UNION RADIO CORPORATION

57 STATE STREET, NEWARK, NEW JERSEY *Supreme in Quality*

© 1941 N. U. R. CODE